

Title : Core Specification 2.8 (UML diagram)
 Filename: CIM_Core28-Final.vsd
 Author : DMTF SysDev-wg
 Date : 01/26/2004

Page 1 : Overview

Page 2 : ManagedSystemElement

Page 3 : EnabledLogicalElement

Page 4 : Physical Elements and Logical Devices (Including StorageExtents)

Page 5 : Collections

Page 6 : Redundany Groups

Page 7 : Product, FRU, & Software Identity

Page 8 : Statistics

Page 9 : SettingData, Profiles, Capabilities & Power Management

Page 10 : Settings, Configurations & Method Parameters

Page 11 : Association Hierarchy

Page 12 : Dependency Hierarchy

Page 13 : Aggregation Hierarchy

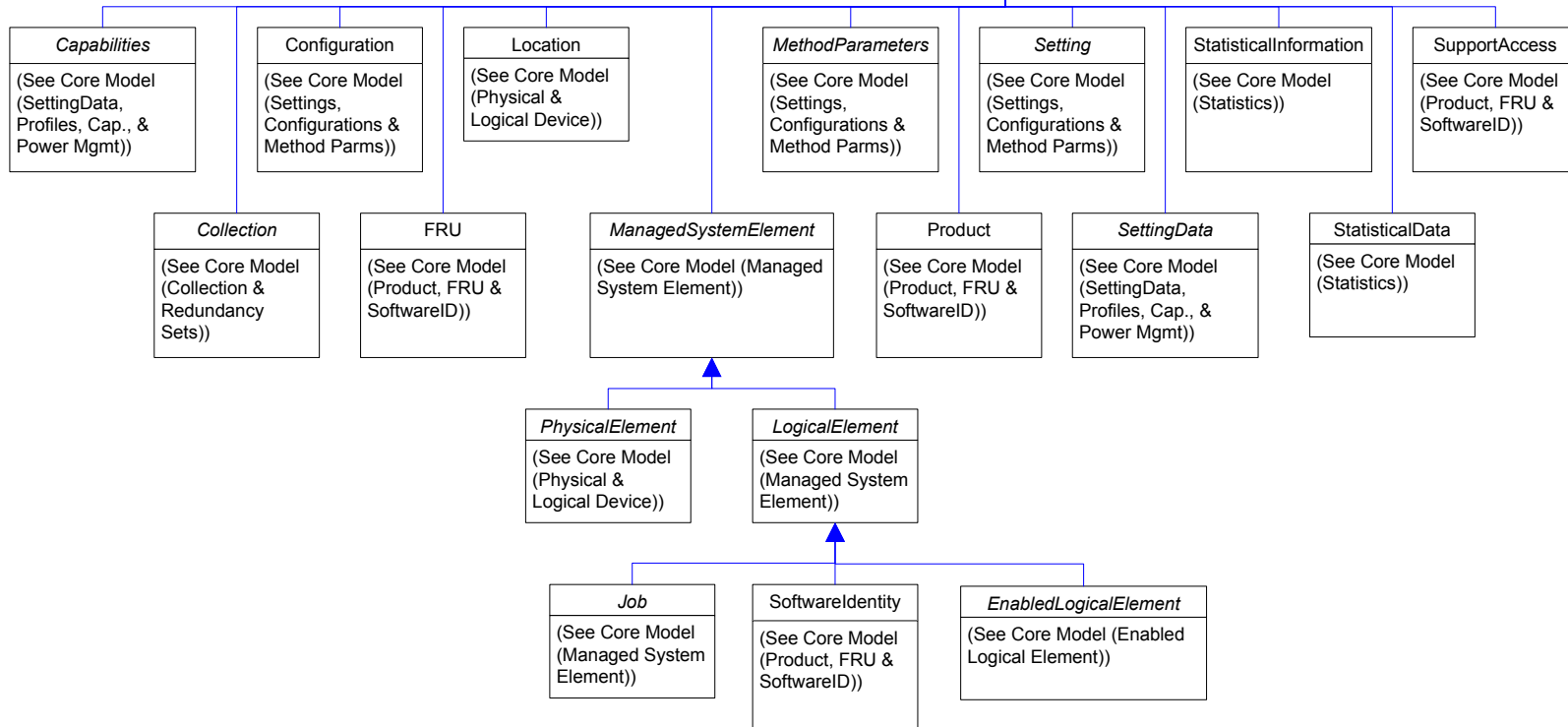
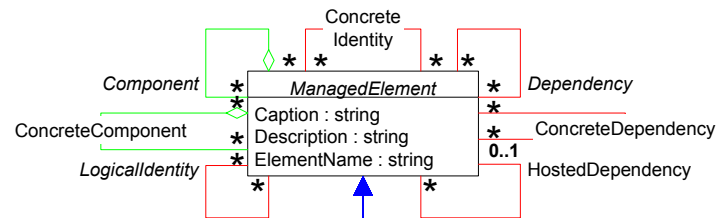
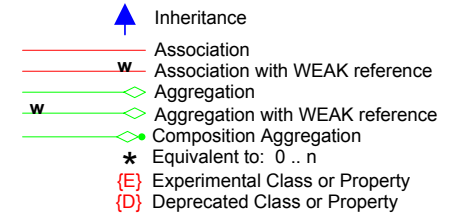

Page 2 : Managed System Elements
 (LogicalElement, Job, EnabledLogicalElement)

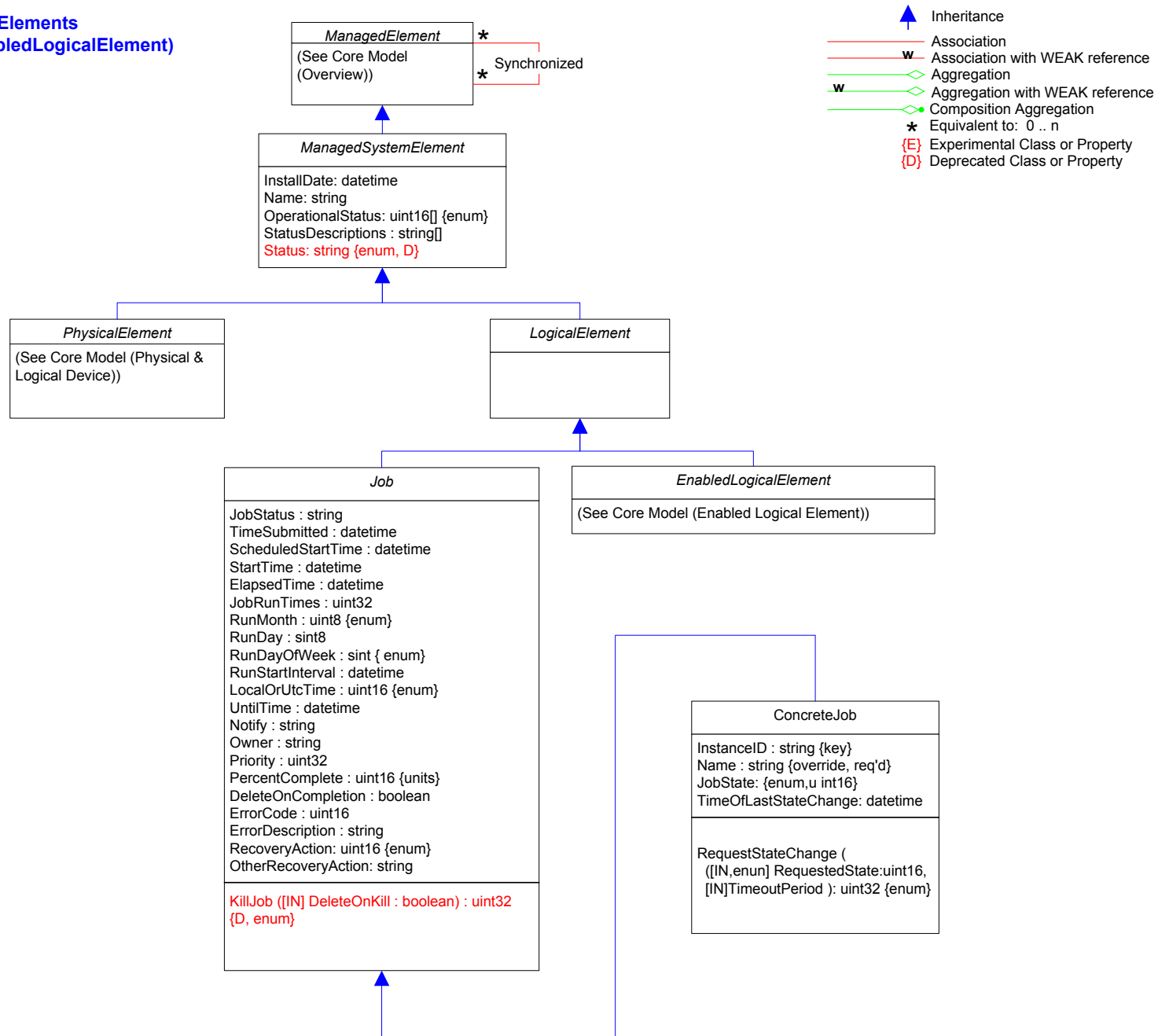

Page 3 : Enabled Logical Elements (Service, ServiceAccessPoint, System)



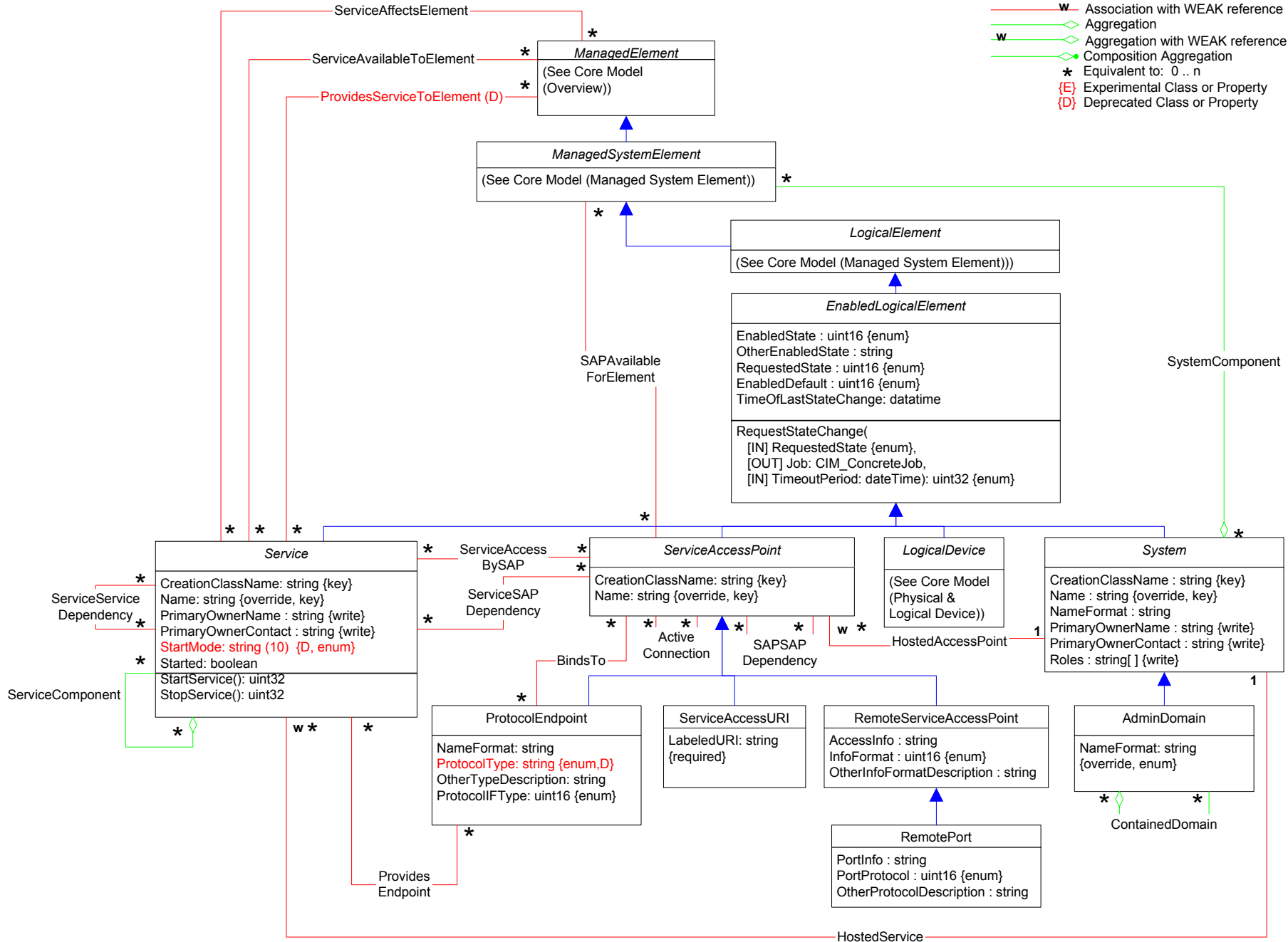



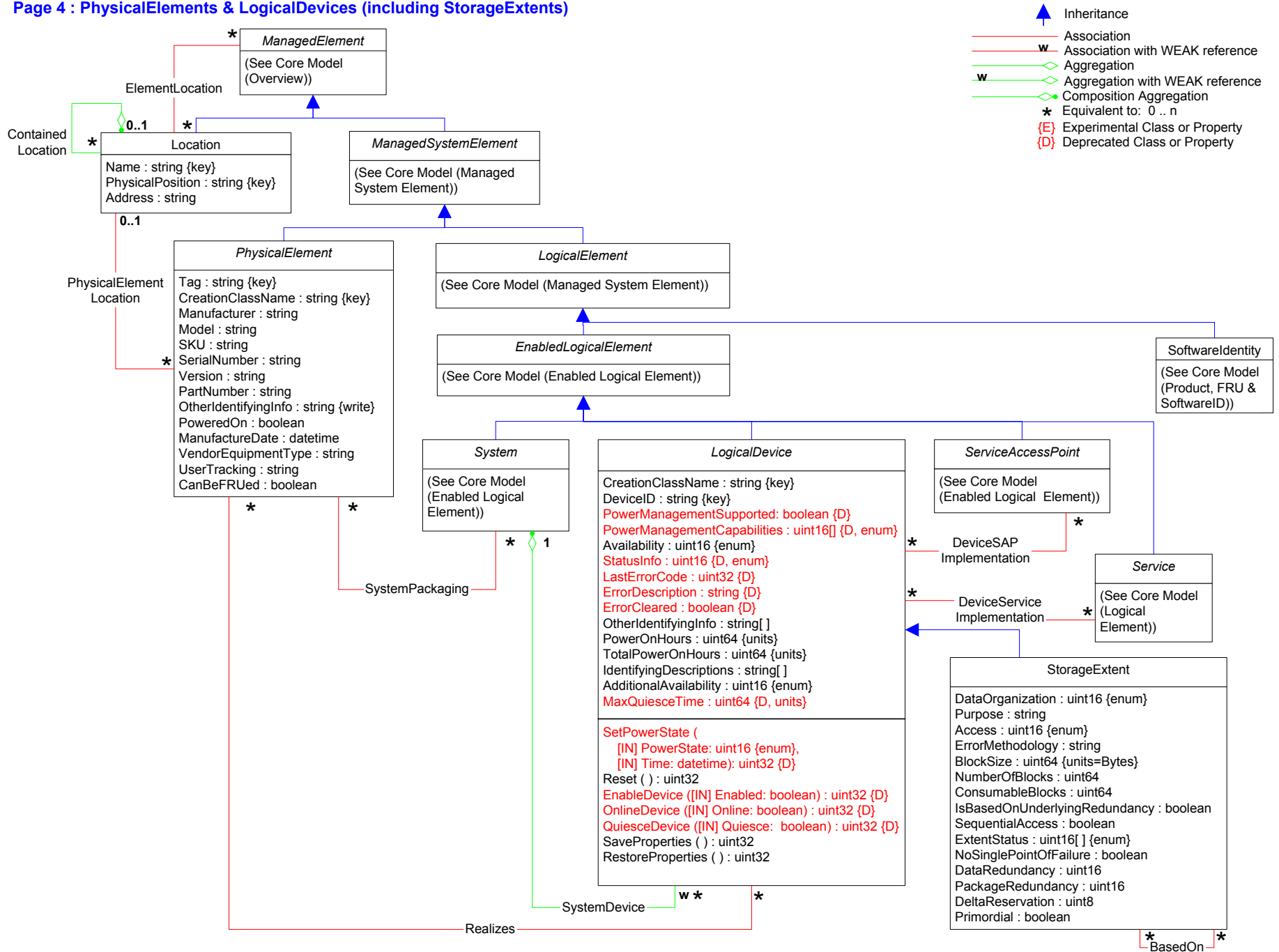

- Inheritance
- Association
- Association with WEAK reference
- Aggregation
- Aggregation with WEAK reference
- Composition Aggregation
- Equivalent to: 0..n
- Experimental Class or Property
- Deprecated Class or Property



Page 4 : PhysicalElements & LogicalDevices (including StorageExtents)







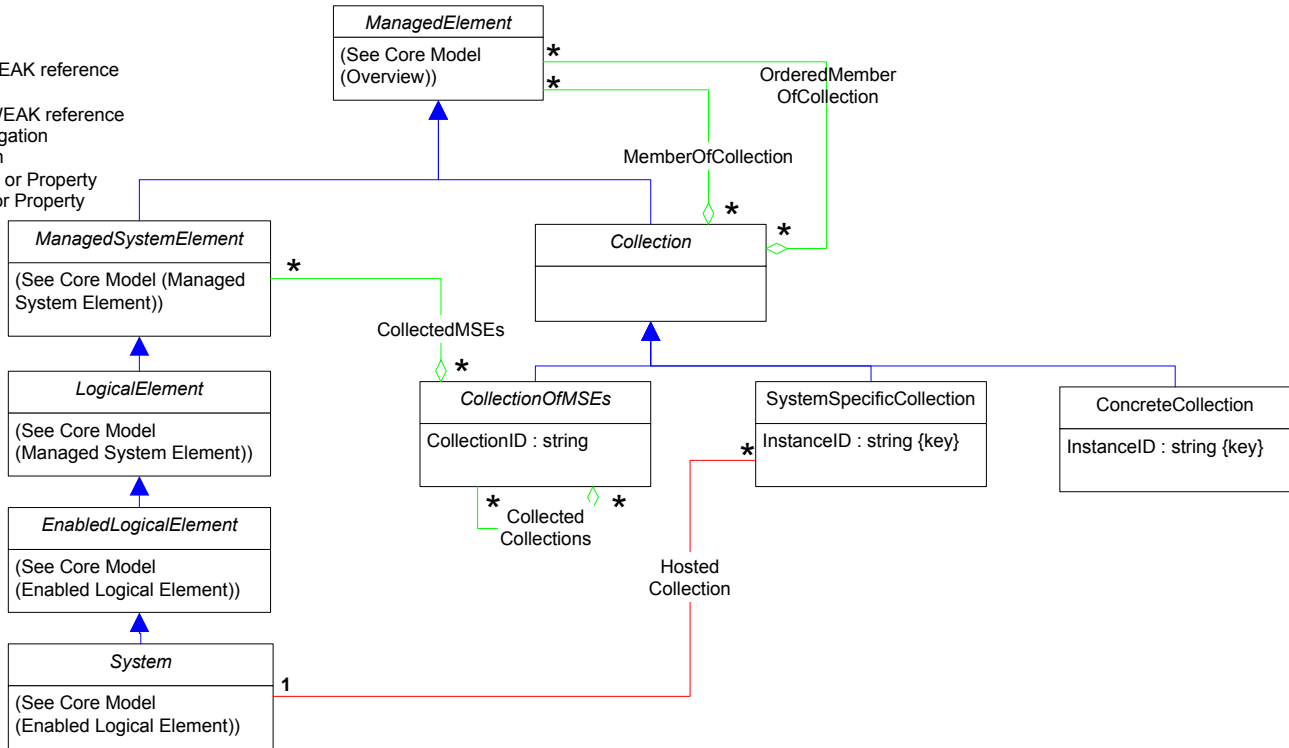



Page 5 : Collections







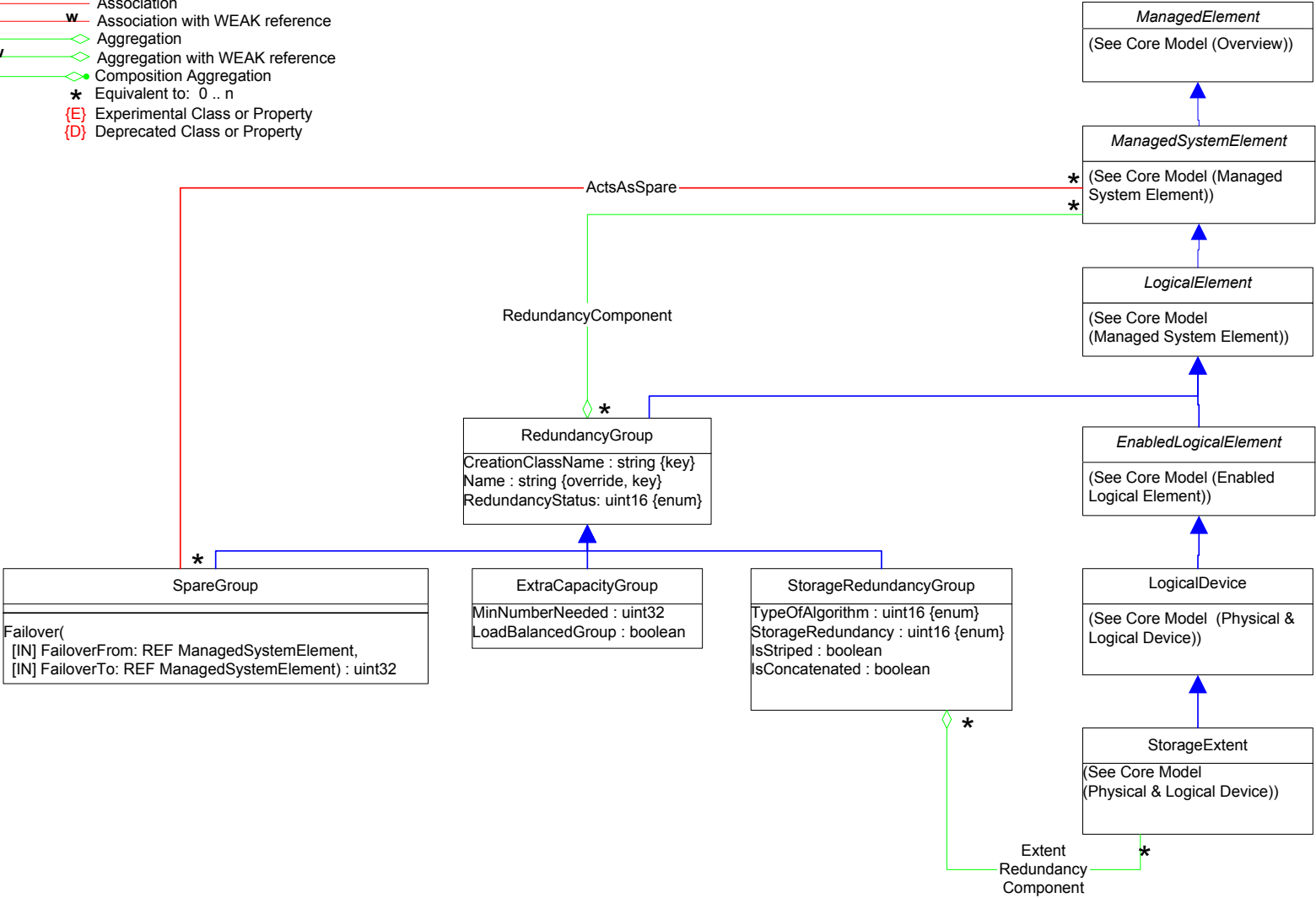

-  Inheritance
-  Association
-  Association with WEAK reference
-  Aggregation
-  Aggregation with WEAK reference
-  Composition Aggregation
-  Equivalent to: 0 .. n
-  Experimental Class or Property
-  Deprecated Class or Property



Page 6 : Redundancy Group







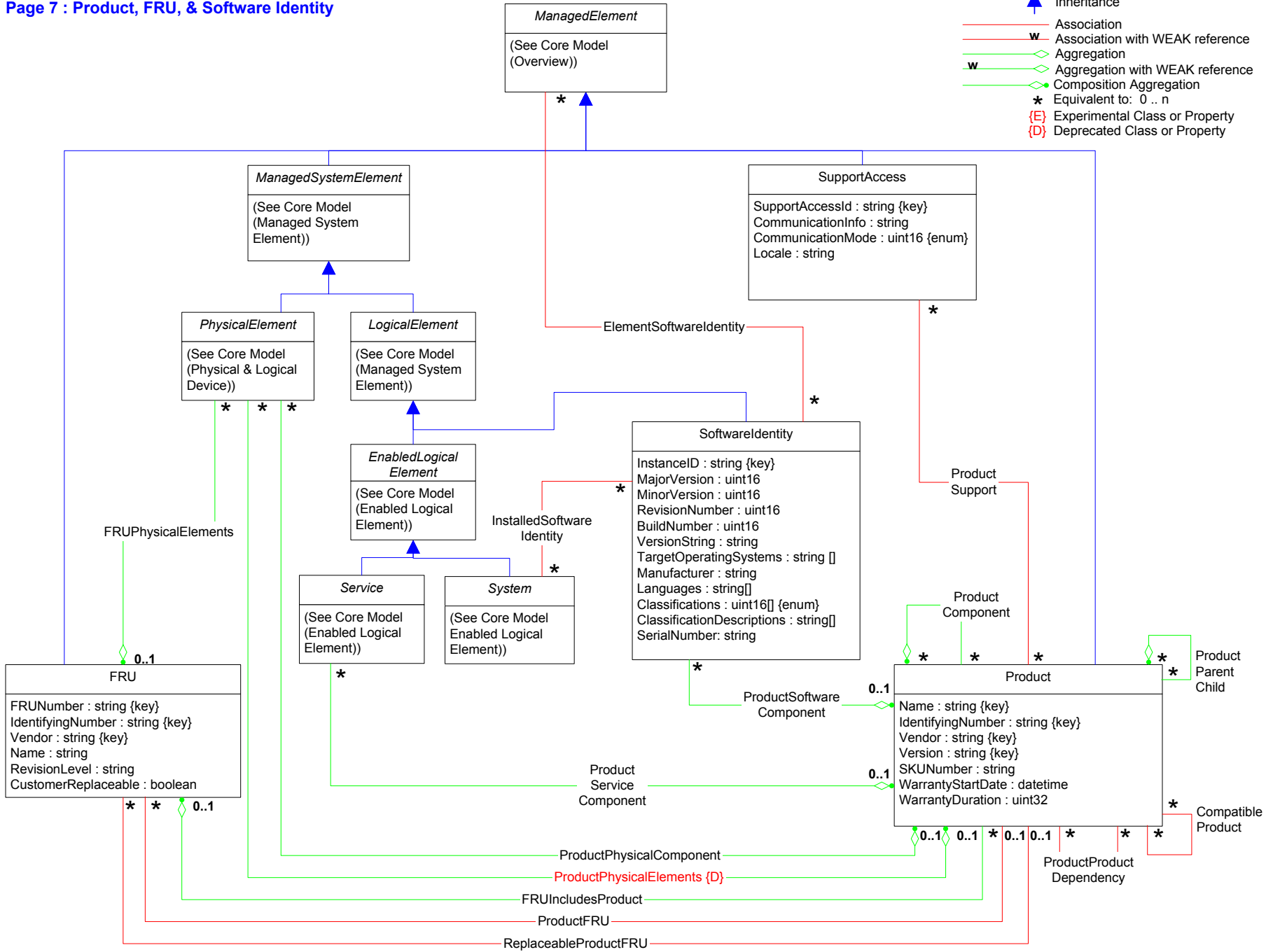

-  Inheritance
-  Association
-  Association with WEAK reference
-  Aggregation
-  Aggregation with WEAK reference
-  Composition Aggregation
-  Equivalent to: 0 .. n
-  Experimental Class or Property
-  Deprecated Class or Property



-  Inheritance
-  Association
-  Association with WEAK reference
-  Aggregation
-  Aggregation with WEAK reference
-  Composition Aggregation
-  Equivalent to: 0..n
-  Experimental Class or Property
-  Deprecated Class or Property



Page 8 : Statistics

-  Inheritance
-  Association
-  Association with WEAK reference
-  Aggregation
-  Aggregation with WEAK reference
-  Composition Aggregation
-  Equivalent to: 0..n
-  Experimental Class or Property
-  Deprecated Class or Property

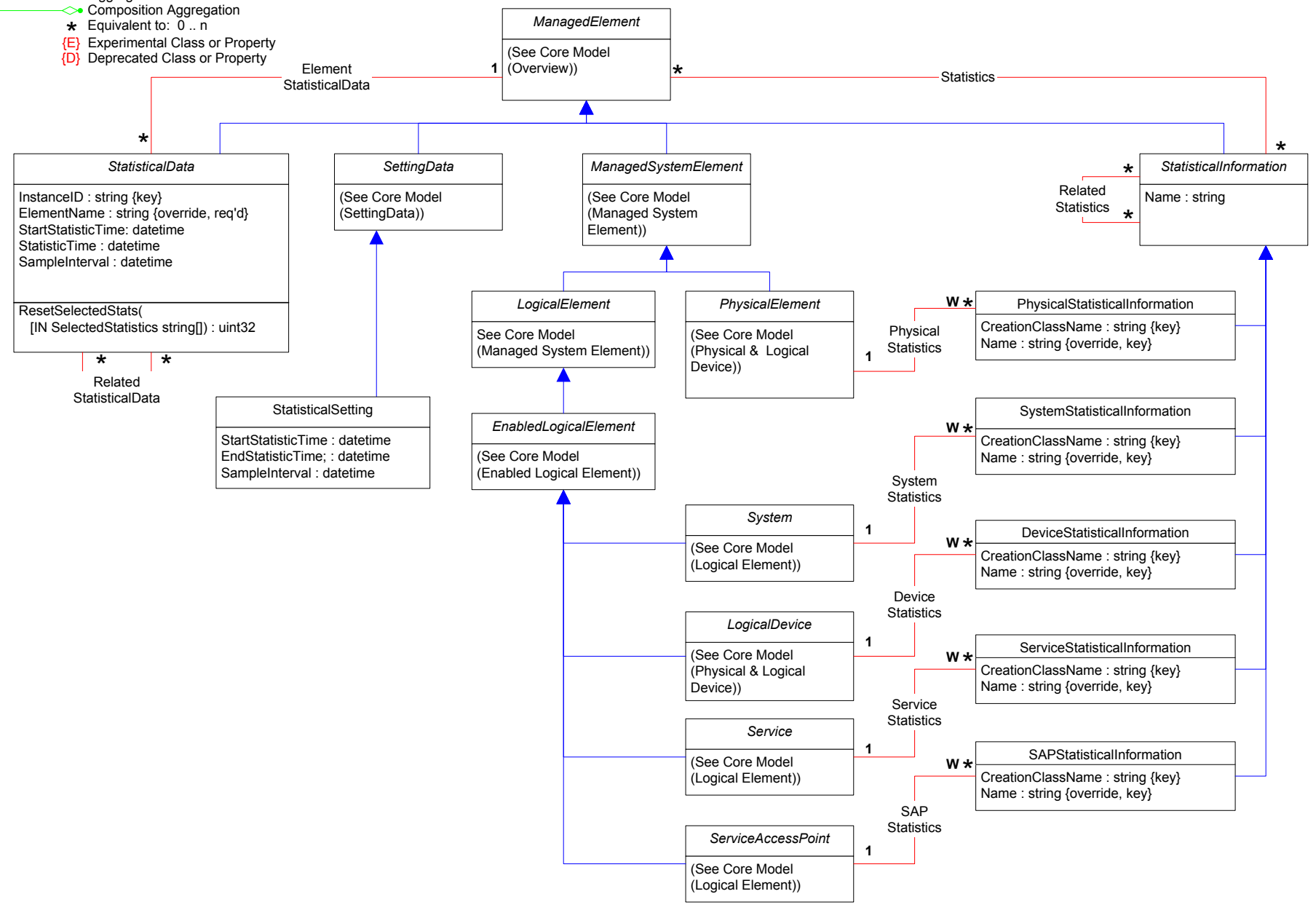

Page 9 : SettingData, Profiles, Capabilities, & Power Management

- Inheritance
- Association
- Association with WEAK reference
- Aggregation
- Aggregation with WEAK reference
- Composition Aggregation
- Equivalent to: 0..n
- Experimental Class or Property
- Deprecated Class or Property

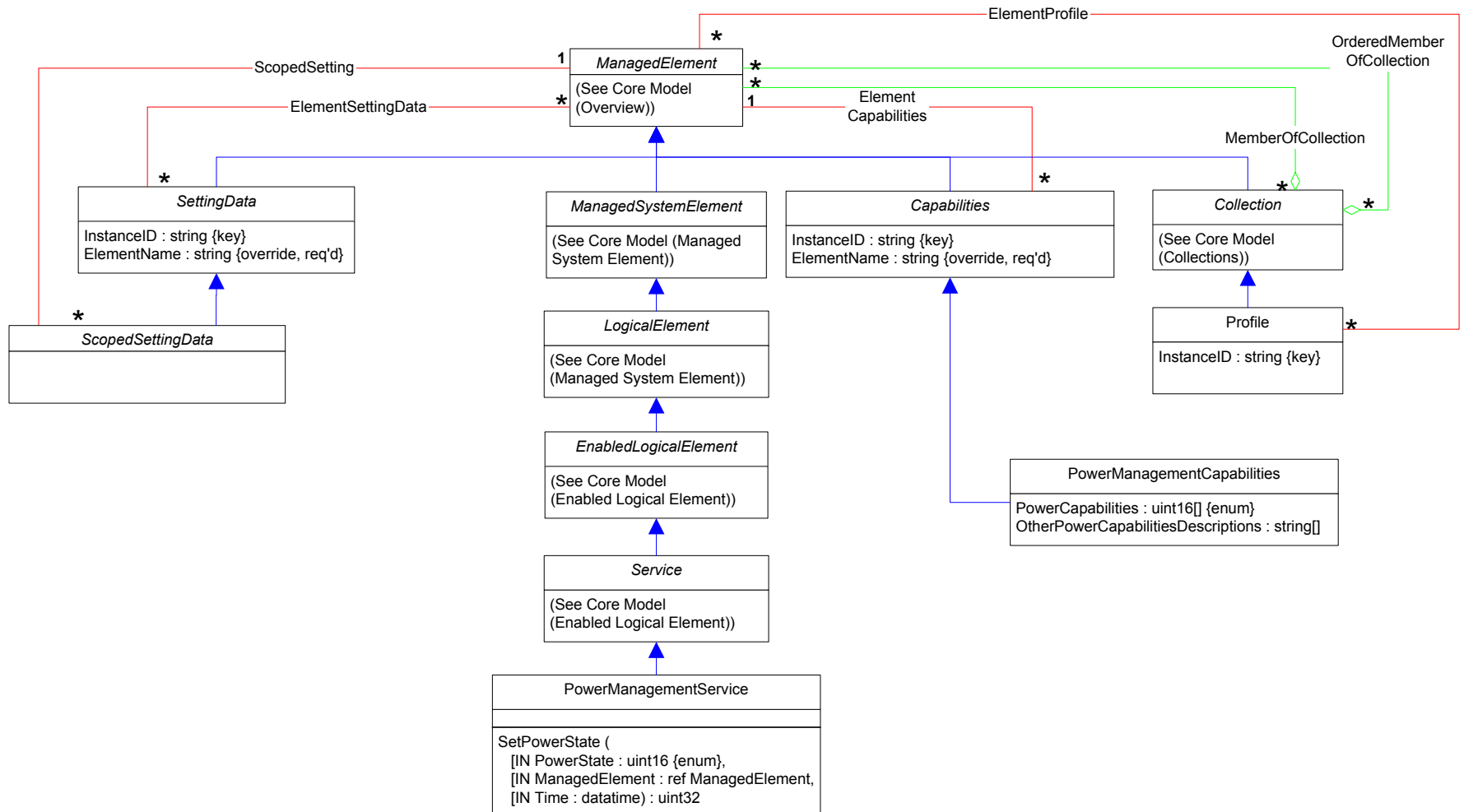

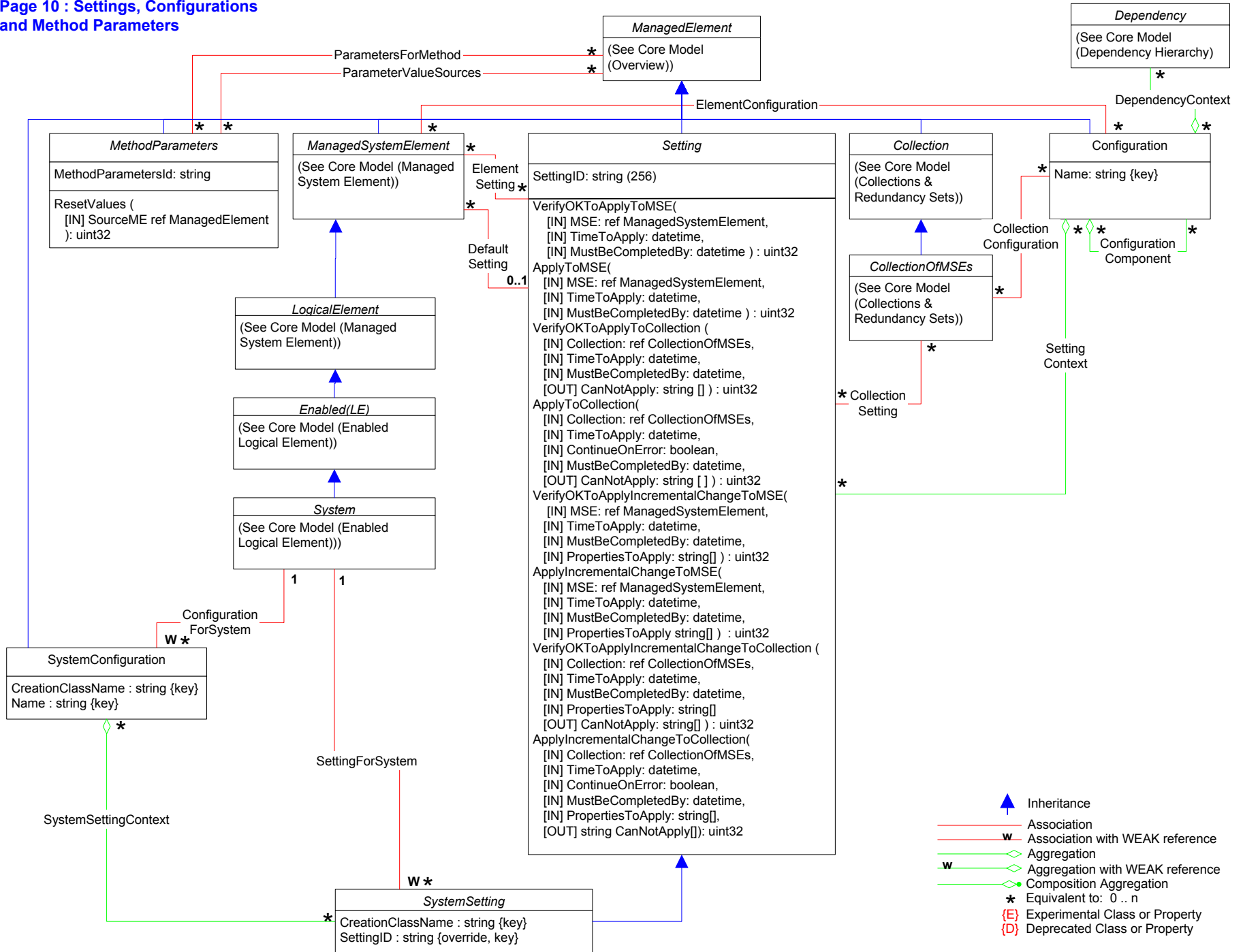

Page 11 : Association Hierarchy

ActsAsSpare
Group: ref SpareGroup {key, *}
Spare: ref ManagedSystemElement {key, *}
HotStandby: boolean

CompatibleProduct
Product: ref Product {key, *}
CompatibleProduct: ref Product {key, *}
CompatibilityDescription: string

CollectionConfiguration
Collection: ref CollectionOfMSEs {key, *}
Configuration: ref Configuration {key, *}

CollectionSetting
Collection: ref CollectionOfMSEs {key, *}
Setting: ref Setting {key, *}

ElementCapabilities
ManagedElement: ref ManagedElement {key, 1}
Capabilities: ref Capabilities {key, *}

ElementConfiguration
Element: ref ManagedSystemElement {key, *}
Configuration: ref Configuration {key, *}

ElementLocation
Element: ref ManagedElement {key, *}
PhysicalLocation: ref Location {key, *}

PhysicalElementLocation
Element: ref PhysicalElement {*}
PhysicalLocation: ref Location {0..1}

ElementProfile
ManagedElement: ref ManagedElement {key, 1}
Profile: ref Profile {key, *}

ElementSetting
Element: ref ManagedSystemElement {key, *}
Setting: ref Setting {key, *}

DefaultSetting
Element: ref ManagedSystemElement {*}
Setting: ref Setting {0..1}

ElementSettingData
ManagedElement: ref ManagedElement {key, *}
SettingData: ref SettingData {key, *}
IsDefault: uint16 {enum}
IsCurrent: uint16 {enum}

ElementStatisticalData
ManagedElement: ref ManagedElement {key, 1}
Stats: ref StatisticalData {key, *}

InstalledSoftwareIdentity
System: ref System {key, *}
InstalledSoftware: ref SoftwareIdentity {key, *}

LogicalIdentity
SystemElement: ref ManagedElement {key, *}
SameElement: ref ManagedElement {key, *}

ConcreteIdentity
SystemElement: ref ManagedElement {*}
SameElement: ref ManagedElement {*}

ParametersForMethod
Parameters ref MethodParameters {key, *}
TheMethod ref ManagedElement {key, *}
MethodName: string {key}

ParameterValueSources
Parameters ref MethodParameters {key, *}
ValueSource ref ManagedElement {key, *}

ProductFRU
Product: ref Product {key, 0..1}
FRU: ref FRU {key, *}

ProductProductDependency
RequiredProduct: ref Product {key, *}
DependentProduct: ref Product {key, *}
TypeOfDependency: uint16 {enum}

ProductSupport
Product: ref Product {key, *}
Support: ref SupportAccess {key, *}

RelatedStatisticalData
Stats: ref StatisticalData {key, *}
RelatedStats: ref StatisticalData {key, *}
Descriptor: string

RelatedStatistics
Stats: ref StatisticalInformation {key, *}
RelatedStats: ref StatisticalInformation {key, *}

ReplaceableProductFRU
Product: ref Product {key, 0..1}
FRU: ref FRU {key, *}

SAPAvailableForElement
AvailableSAP: ref ServiceAccessPoint {key, *}
ManagedElement: ref ManagedElement {key, *}

Statistics
Stats: ref StatisticalInformation {key, *}
Element: ref ManagedElement {key, *}

DeviceStatistics
Stats: ref DeviceStatisticalInformation {weak, *}
Element: ref LogicalDevice {1}

SystemStatistics
Stats: ref SystemStatisticalInformation {weak, *}
Element: ref System {1}

ServiceStatistics
Stats: ref ServiceStatisticalInformation {weak, *}
Element: ref Service {1}

SAPStatistics
Stats: ref SAPStatisticalInformation {weak, *}
Element: ref ServiceAccessPoint {1}

PhysicalStatistics
Stats: ref PhysicalStatisticalInformation {weak, *}
Element: ref PhysicalElement {1}

ServiceAffectsElement
AffectedElement: ref ManagedElement {key, *}
AffectingElement: ref Service {key, *}
ElementEffects: uint16[] {enum}
OtherElementEffectsDescriptions: string[]

ServiceAvailableToElement
ServiceProvided: ref Service {key, *}
UserOfService: ref ManagedElement {key, *}

Synchronized
SystemElement: ref ManagedElement {key, *}
SyncedElement: ref ManagedElement {key, *}
WhenSynced: datetime
SyncMaintained: boolean

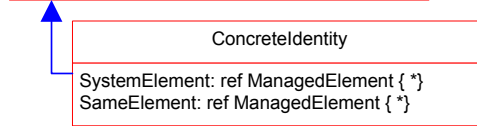
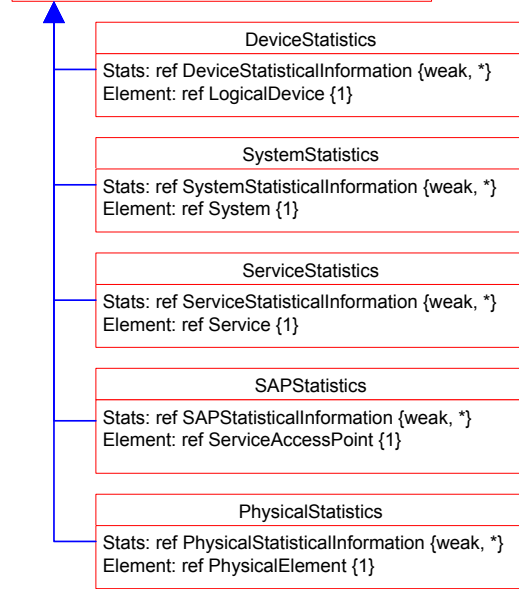
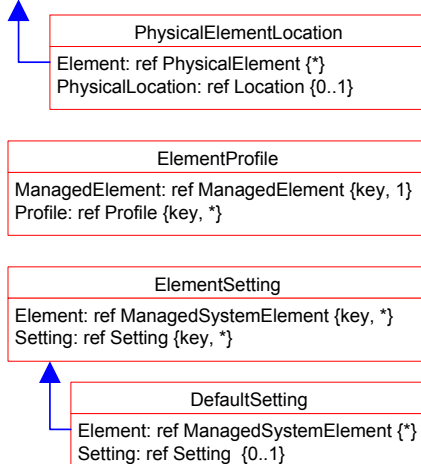

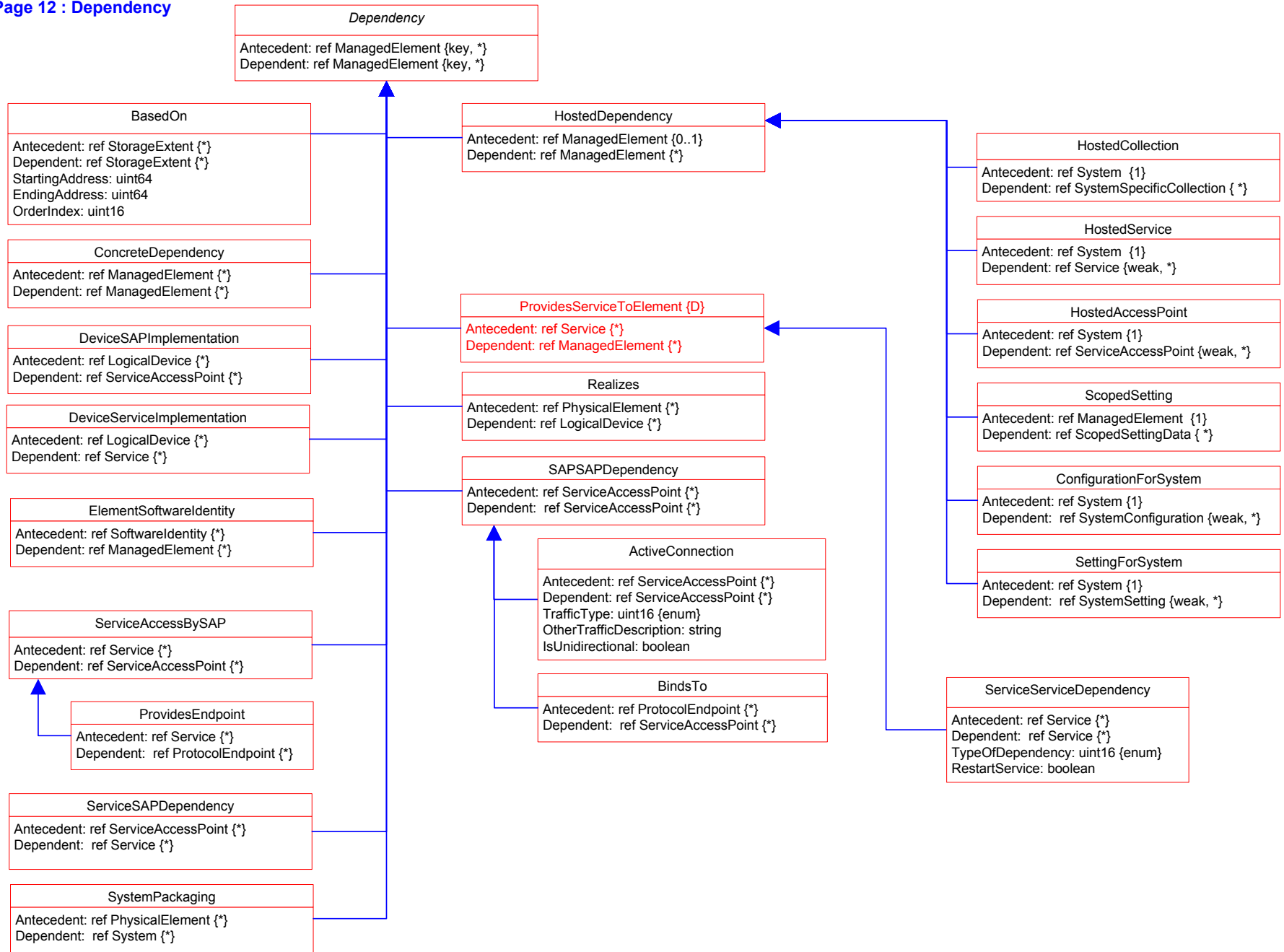

Page 13 : Aggregation Hierarchy

