









Title : System Specification V2.13
 Filename : CIM_System.vsd
 Author : DMTF Core Schema WG
 Date : 07 September 2006

- Page 1 : Overview
- Page 2 : Computer System
- Page 3 : Local File Systems
- Page 4 : Remote FS/File Export
- Page 5 : File Import
- Page 6 : FileSystemService
- Page 7 : Operating System
- Page 8 : Processing and Job Queues
- Page 9 : Jobs 2
- Page 10 : Boot Service
- Page 11 : Time
- Page 12 : UNIX
- Page 13 : System Resources
- Page 14 : Message Logs
- Page 15 : Logs 2
- Page 16 : Diagnostics 1
- Page 17 : Diagnostics 2
- Page 18 : Help
- Page 19 : Association Hierarchy
- Page 20 : Dependency Hierarchy
- Page 21 : Aggregation Hierarchy

-  Inheritance
-  Association
-  Association with WEAK reference
-  Aggregation
-  Aggregation with WEAK reference
-  Composition Aggregation
-  Equivalent to: 0..n
-  Experimental Class or Property
-  Deprecated Class or Property

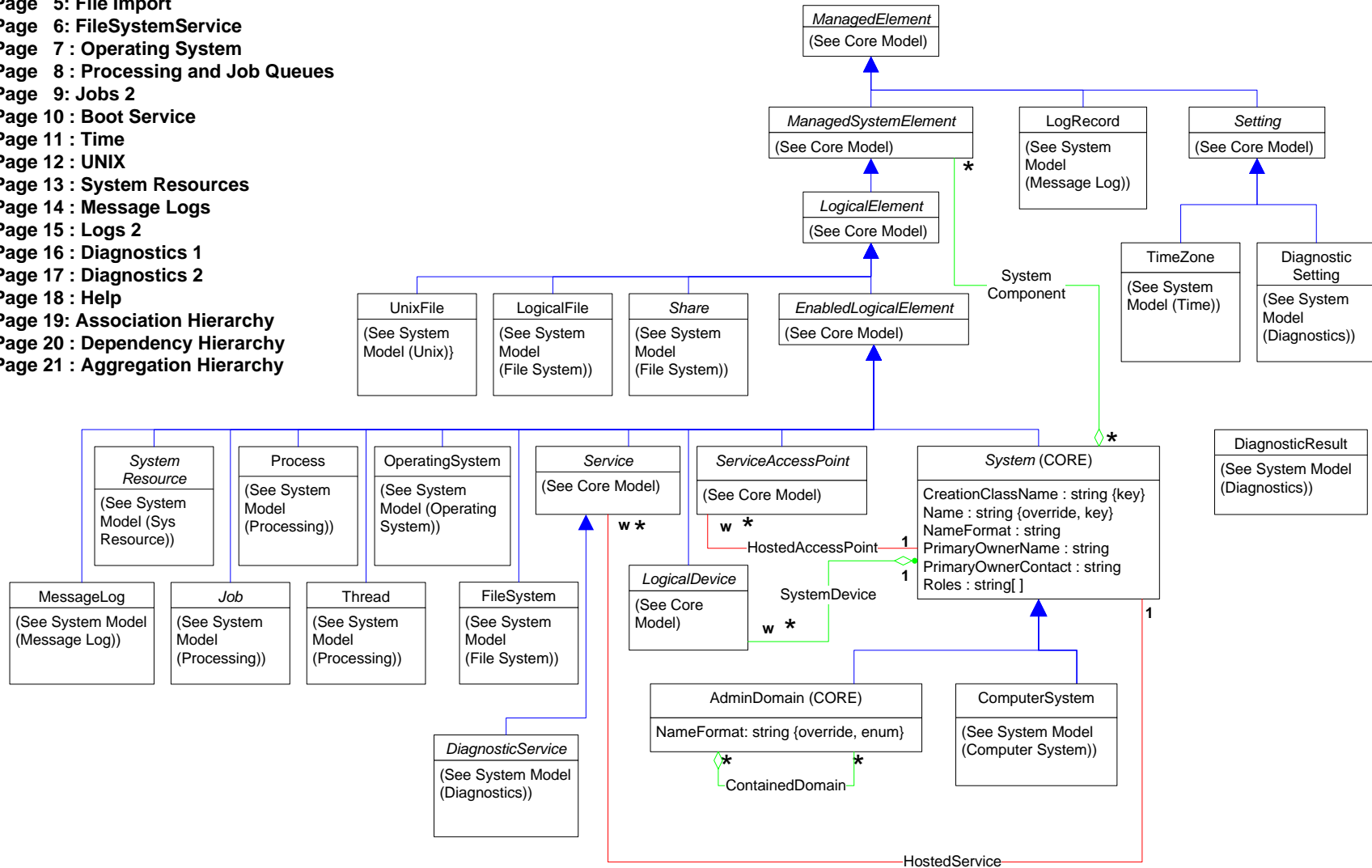

Page 2 : ComputerSystem

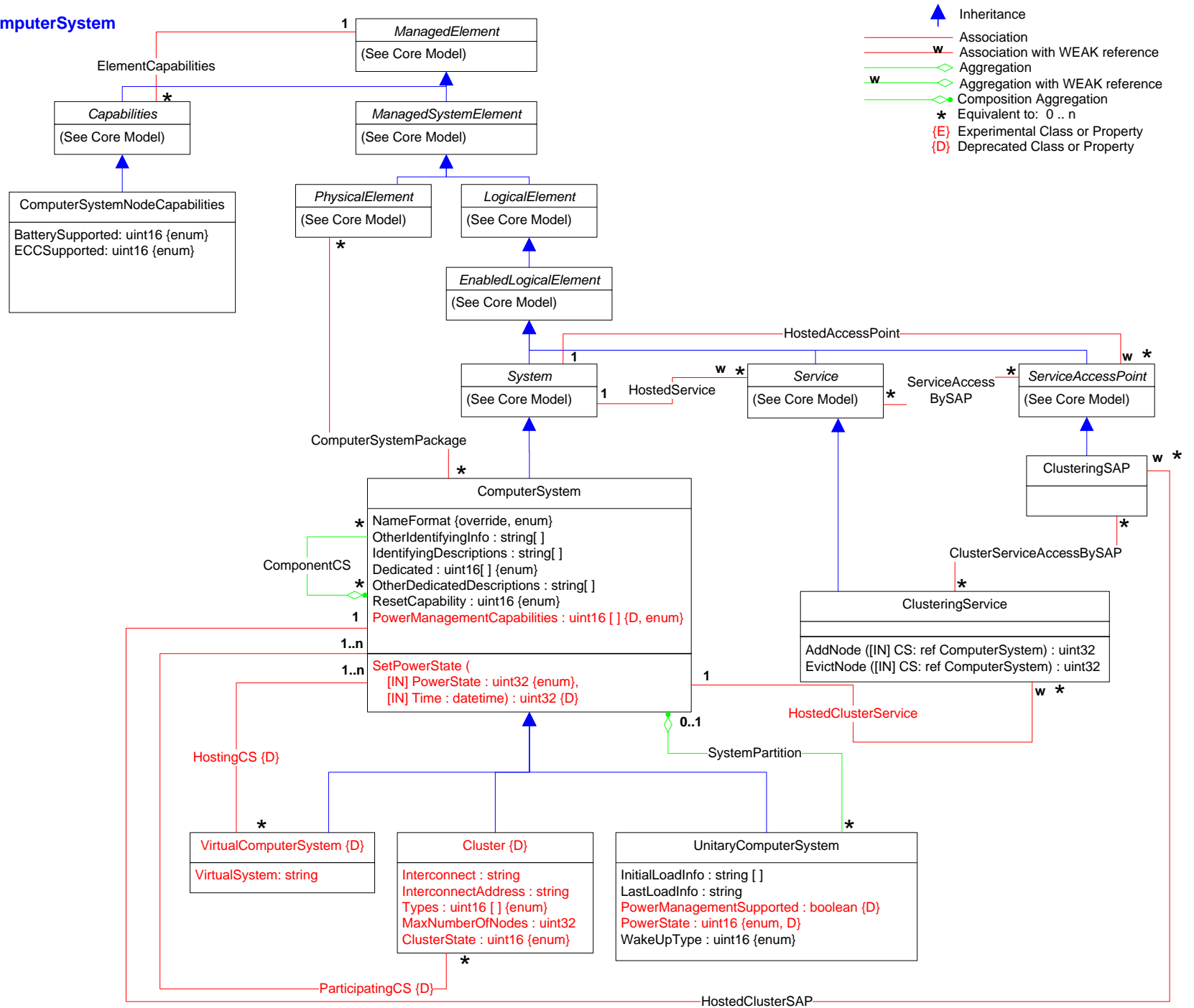

Page 3 : Local File Systems

- ▲ Inheritance
- Association
- w Association with WEAK reference
- ◇ Aggregation
- w Aggregation with WEAK reference
- ◊ Composition Aggregation
- * Equivalent to: 0 .. n
- {E} Experimental Class or Property
- {D} Deprecated Class or Property

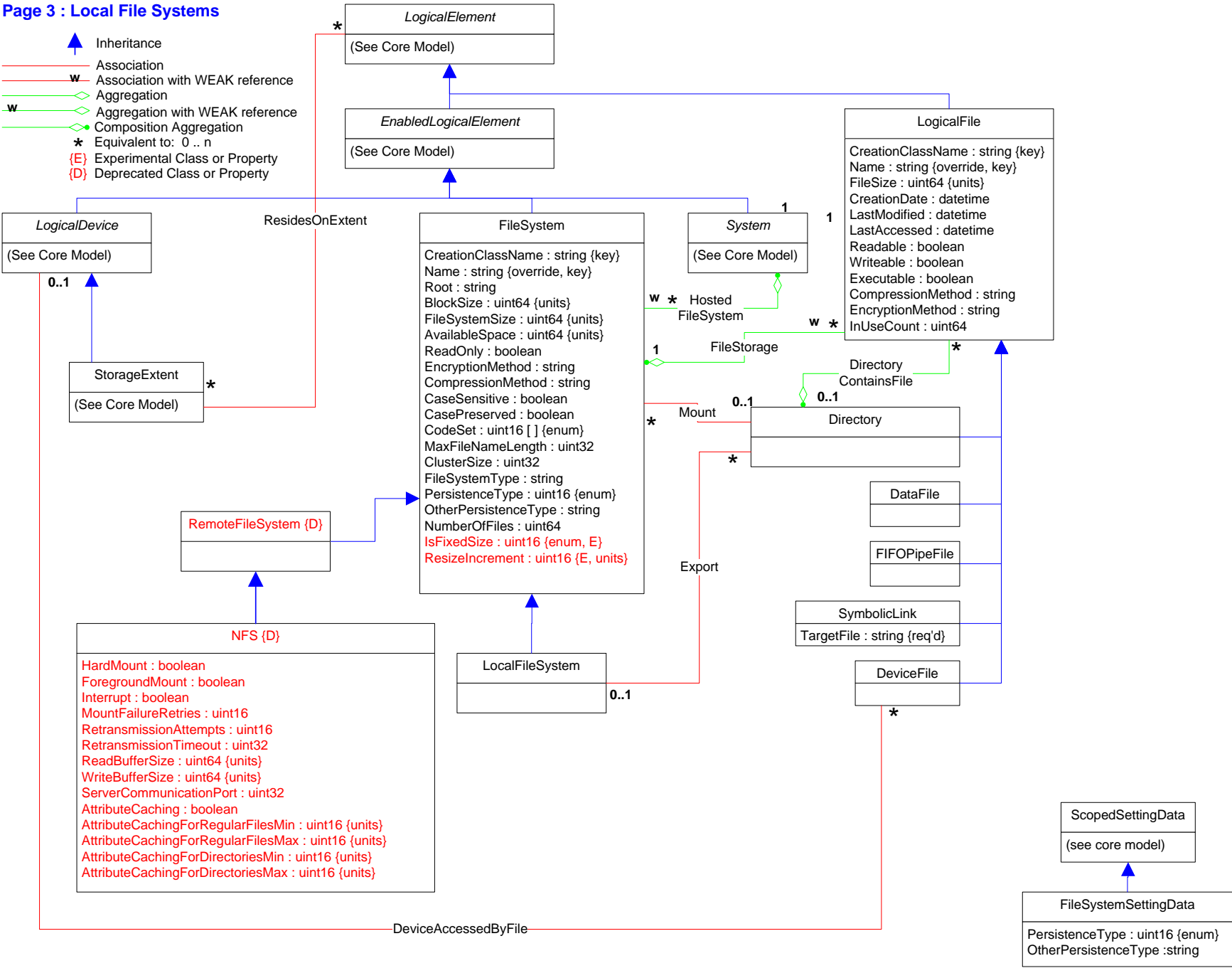





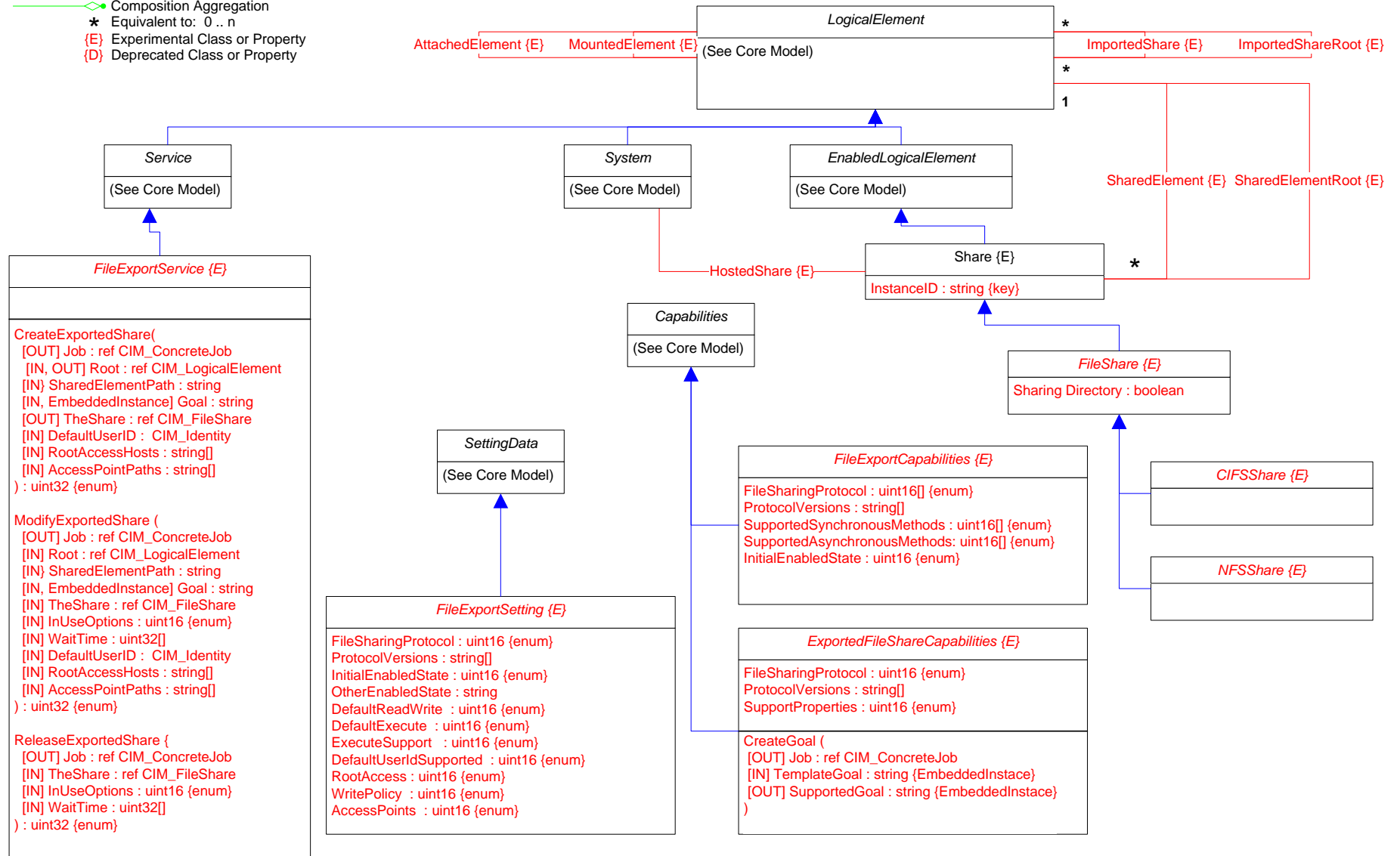



Page 4 : Remote File Systems / File Export Service

- ▲ Inheritance
- Association
- w Association with WEAK reference
- ◇ Aggregation
- w Aggregation with WEAK reference
- ◇ Composition Aggregation
- * Equivalent to: 0..n
- {E} Experimental Class or Property
- {D} Deprecated Class or Property







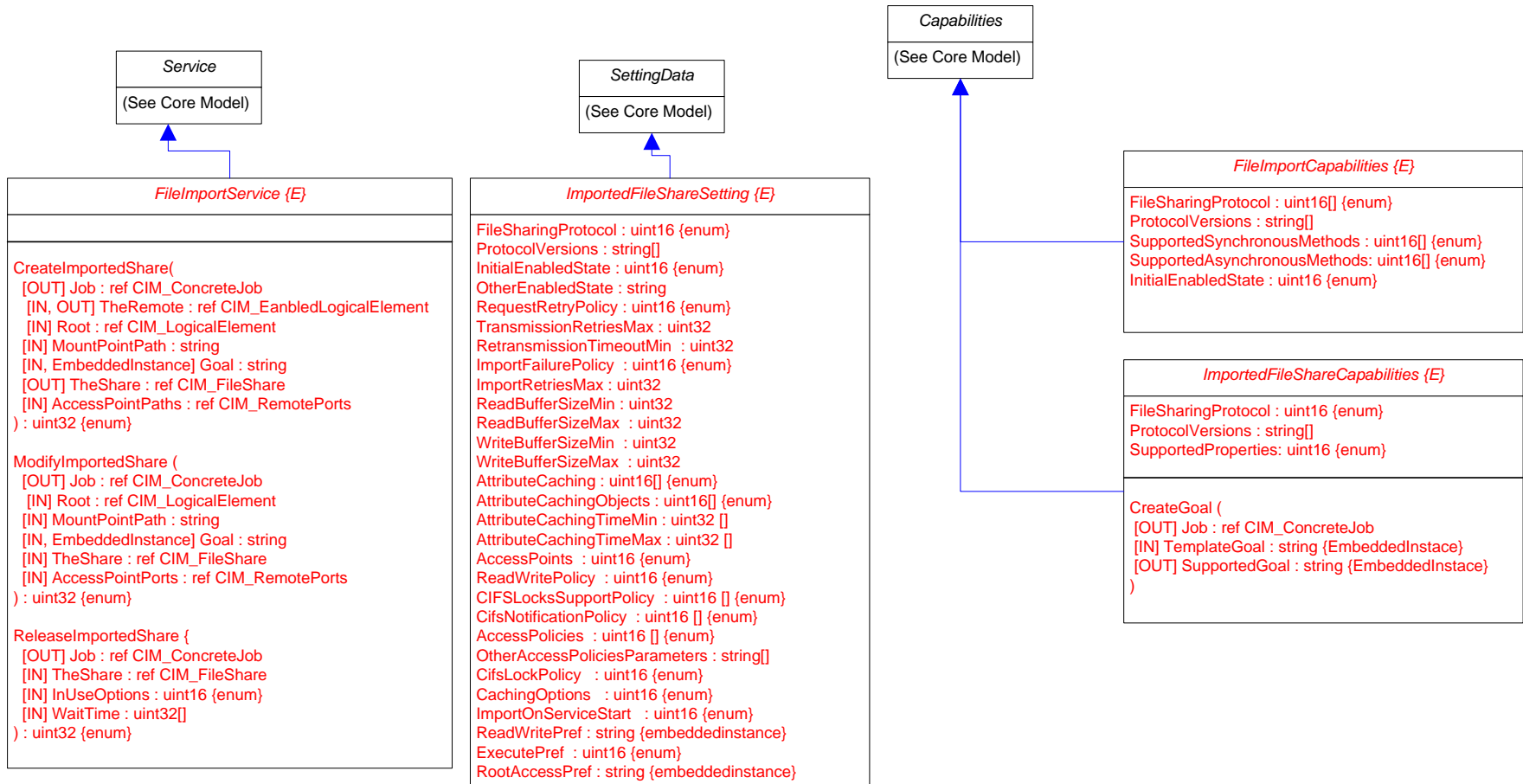



Page 5 : File Import Service

-  Inheritance
-  Association
-  Association with WEAK reference
-  Aggregation
-  Aggregation with WEAK reference
-  Composition Aggregation
-  Equivalent to: 0 .. n
-  {E} Experimental Class or Property
-  {D} Deprecated Class or Property







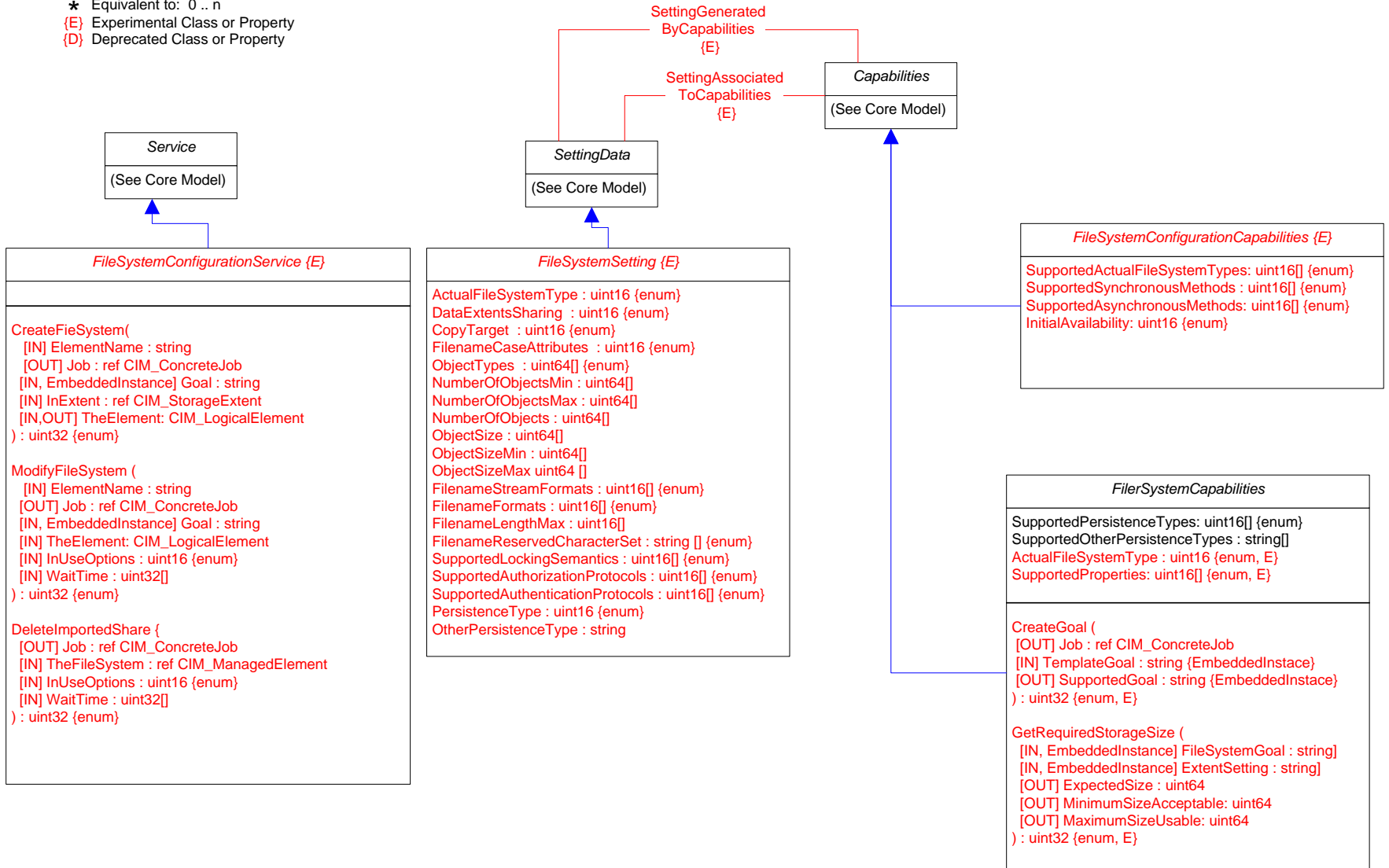



Page 6 : File Import Service

-  Inheritance
-  Association
-  Association with WEAK reference
-  Aggregation
-  Aggregation with WEAK reference
-  Composition Aggregation
-  Equivalent to: 0..n
-  Experimental Class or Property
-  Deprecated Class or Property







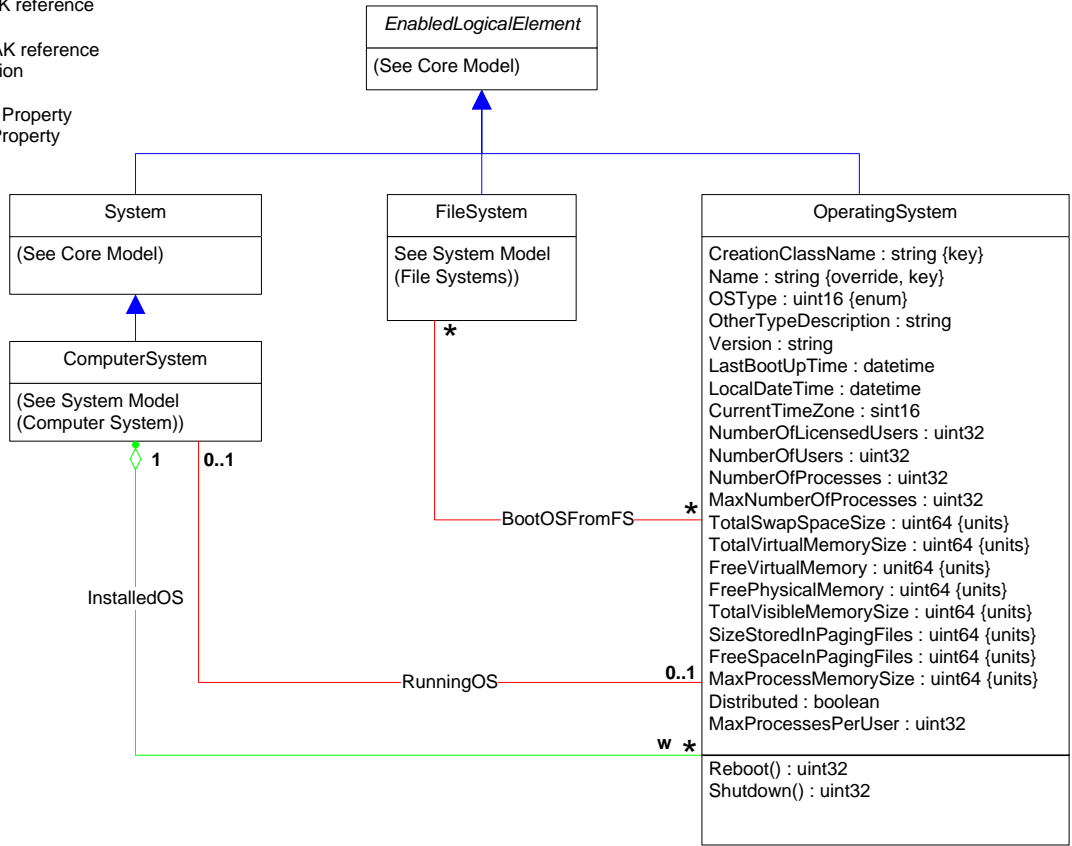

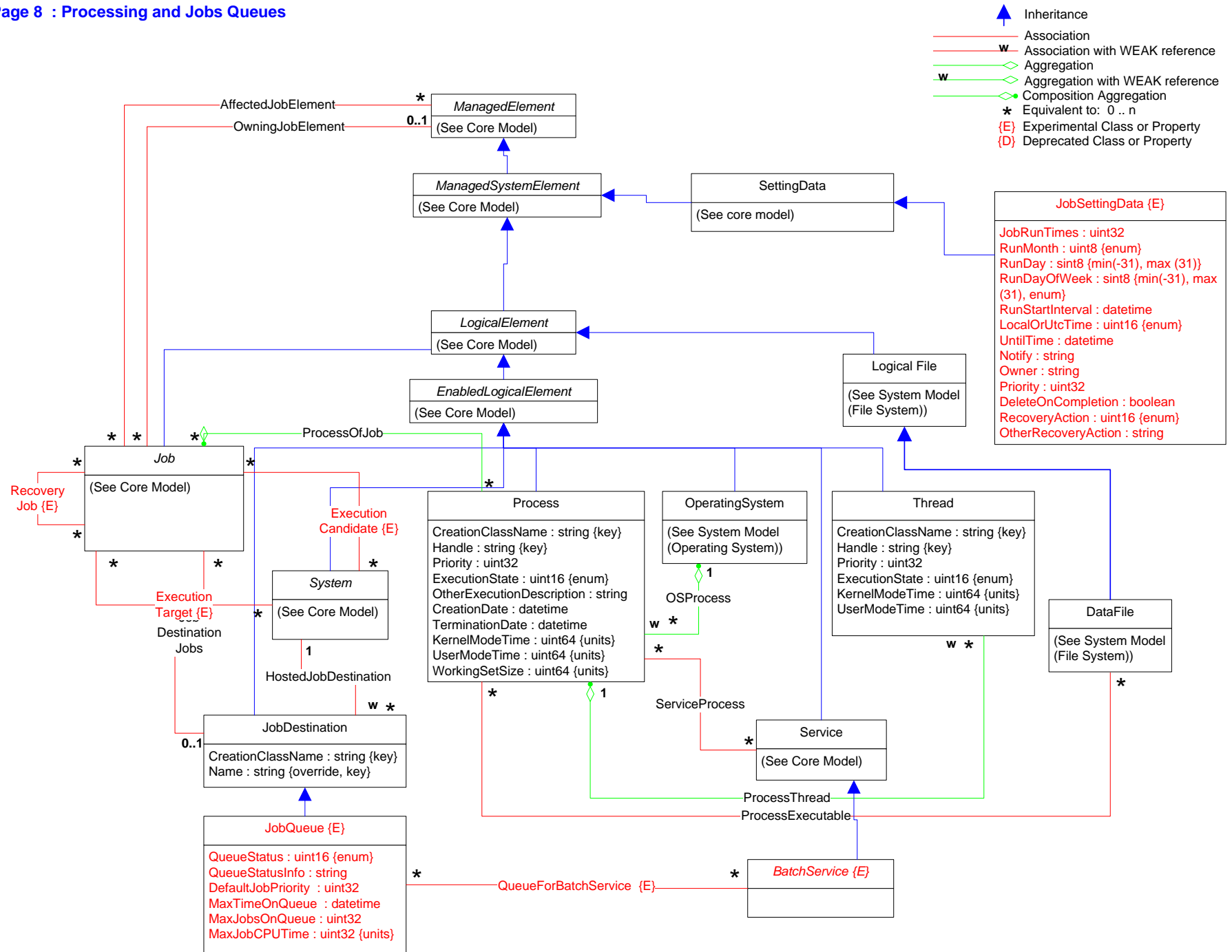

Page 7 : Operating System

-  Inheritance
-  Association
-  Association with WEAK reference
-  Aggregation
-  Aggregation with WEAK reference
-  Composition Aggregation
-  Equivalent to: 0 .. n
-  Experimental Class or Property
-  Deprecated Class or Property





-  Inheritance
-  Association
-  Association with WEAK reference
-  Aggregation
-  Aggregation with WEAK reference
-  Composition Aggregation
-  Equivalent to: 0..n
-  Experimental Class or Property
-  Deprecated Class or Property

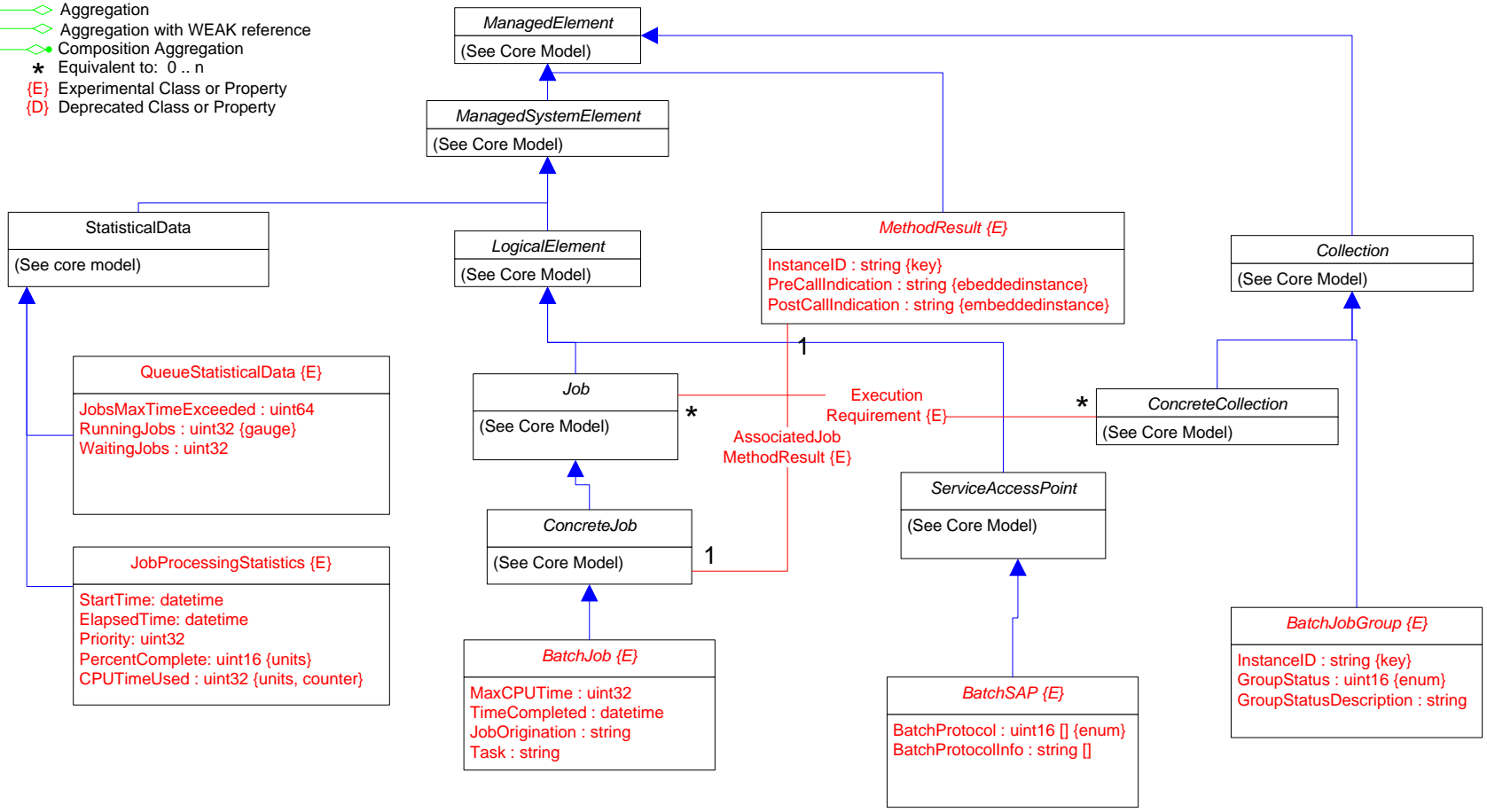

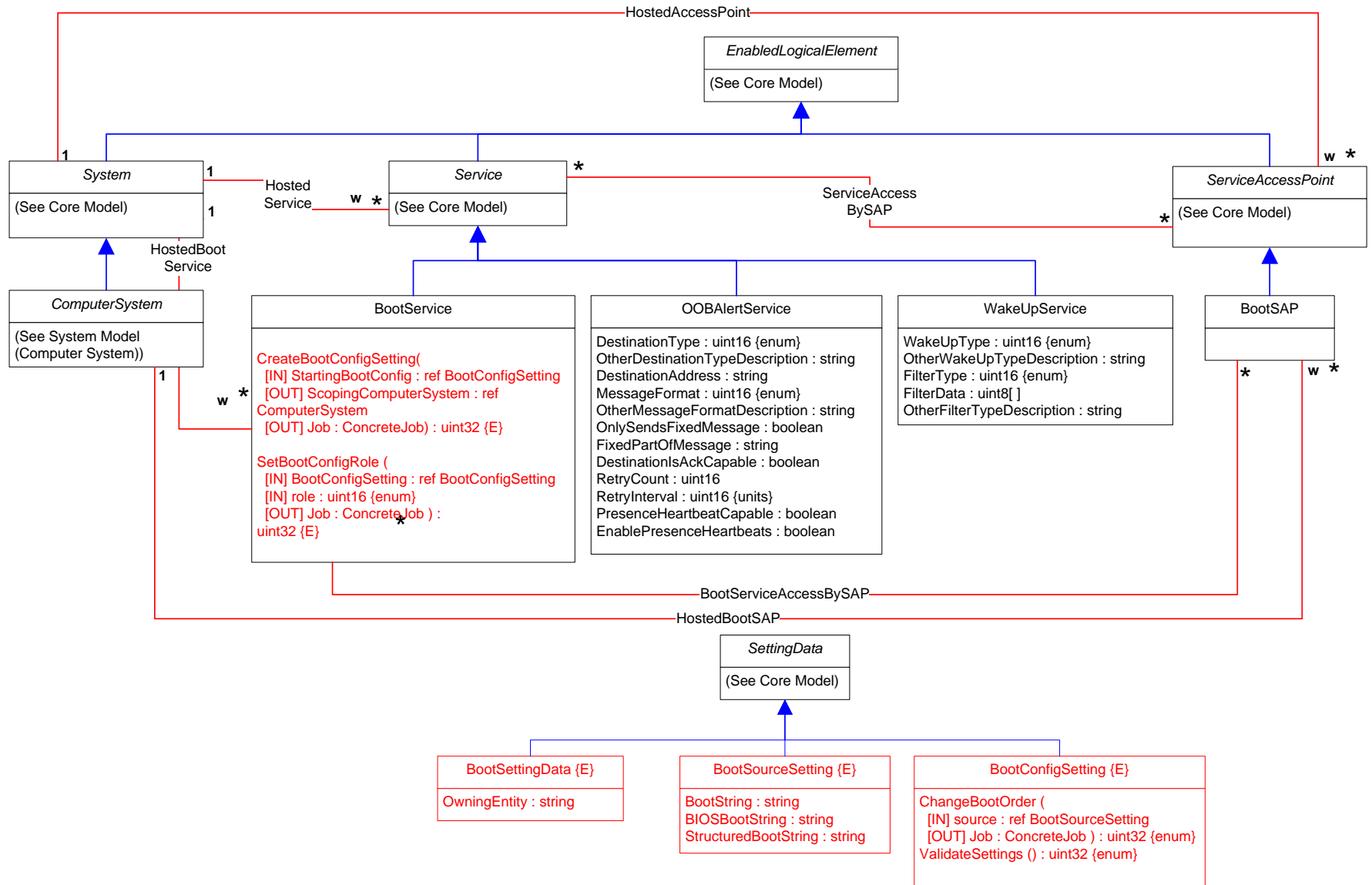
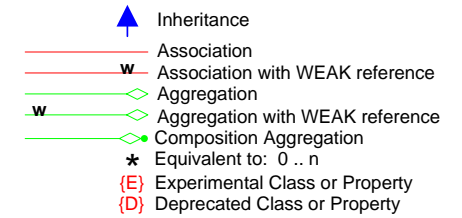

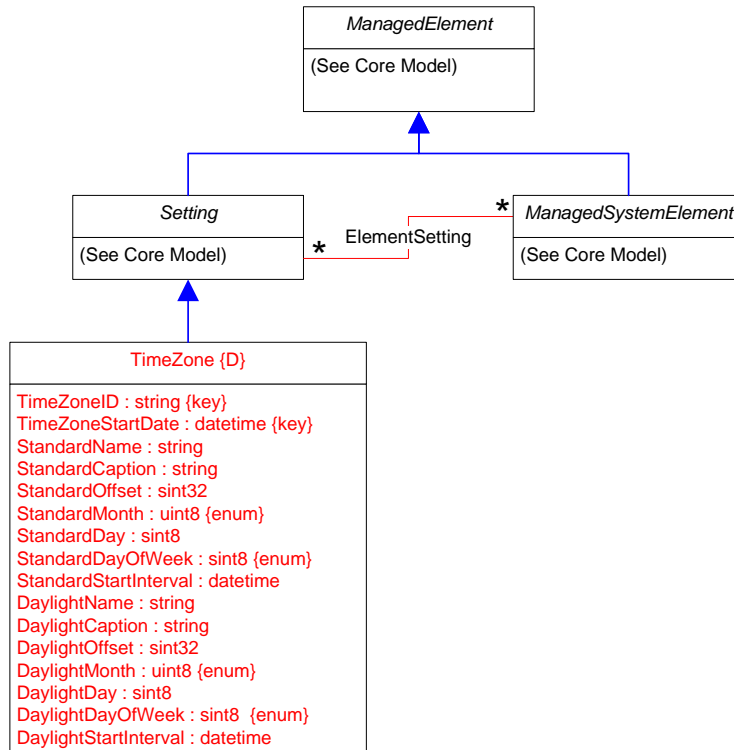
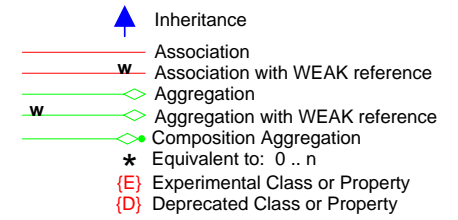

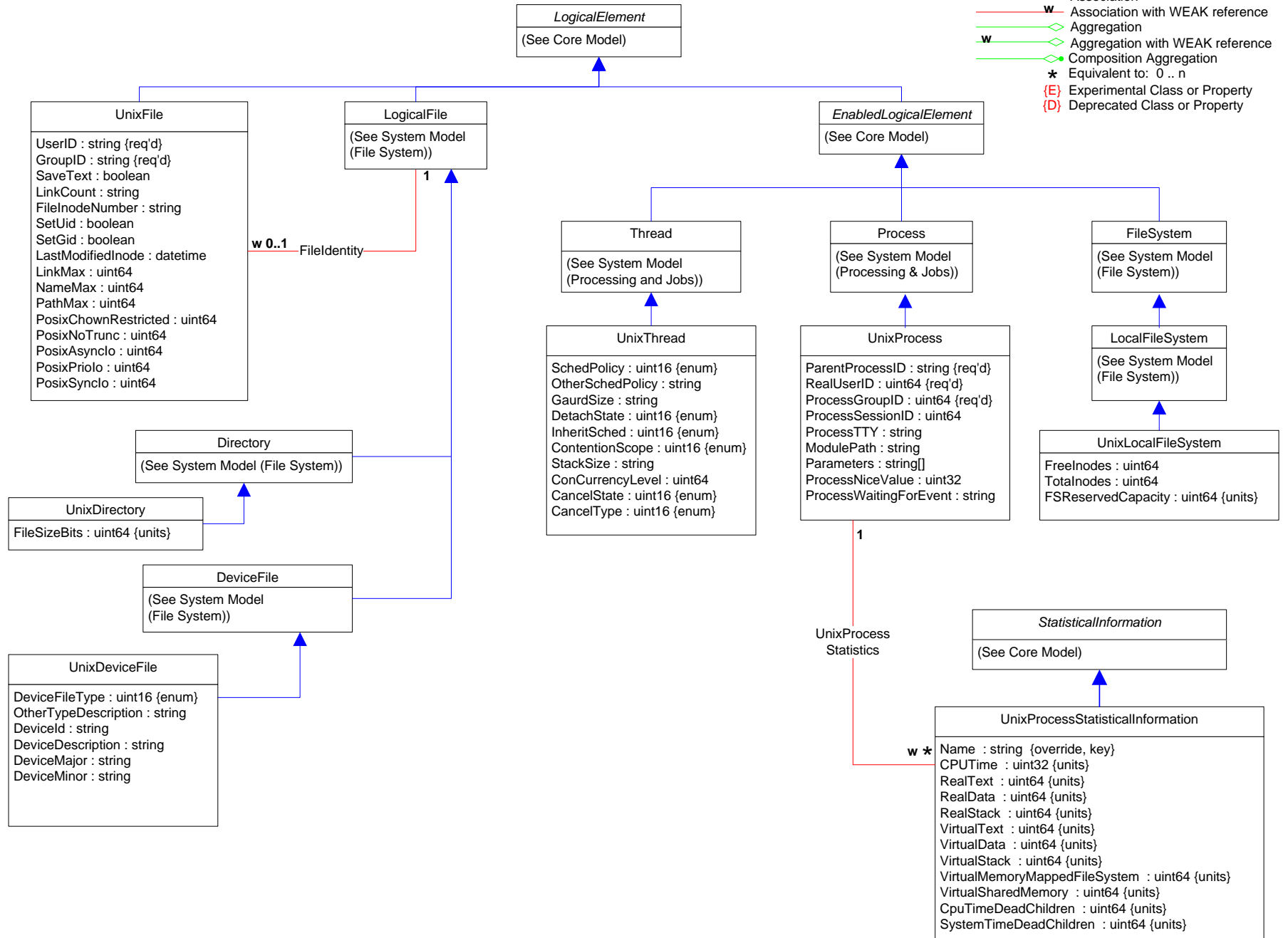
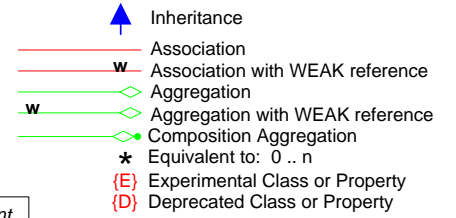

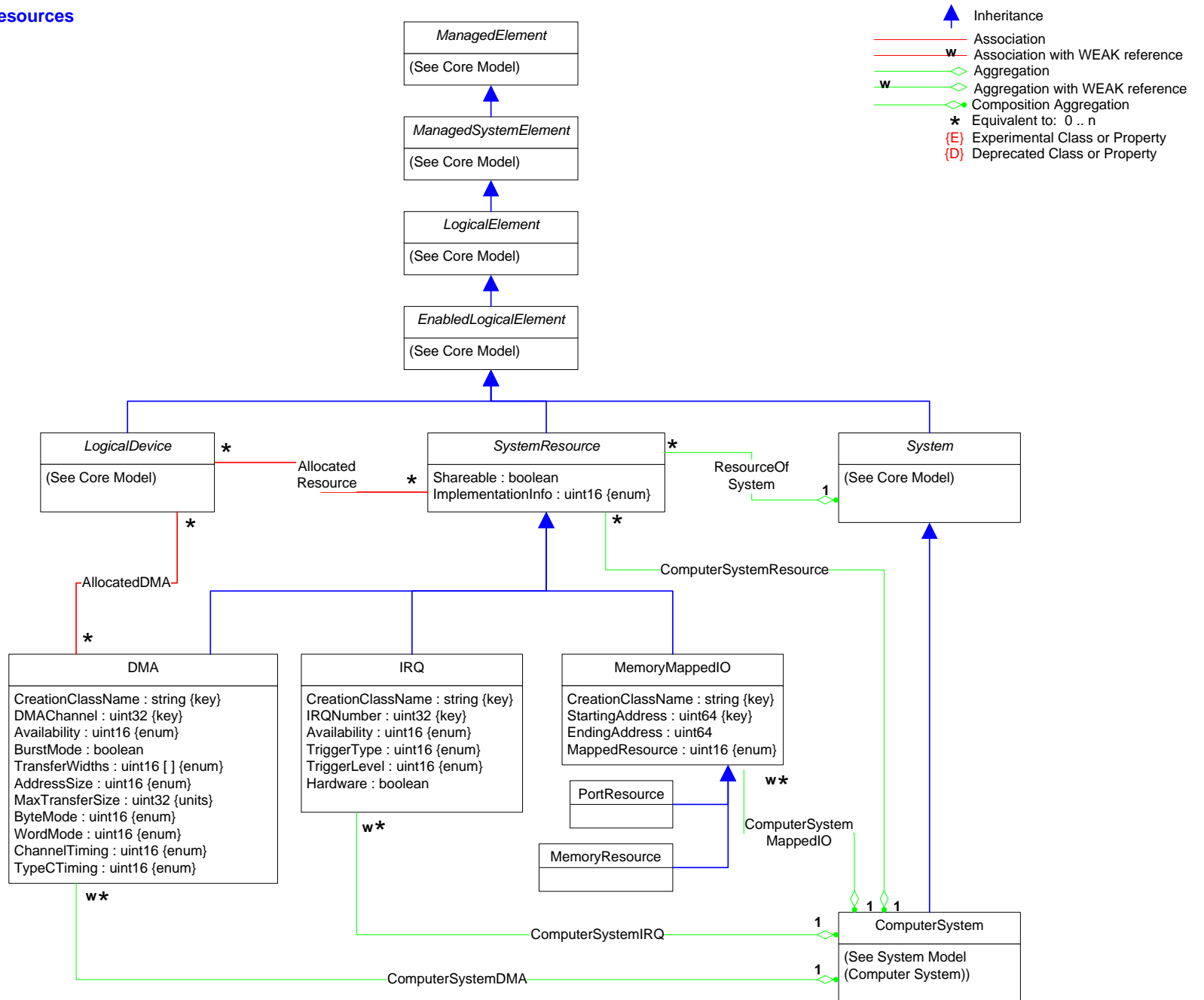

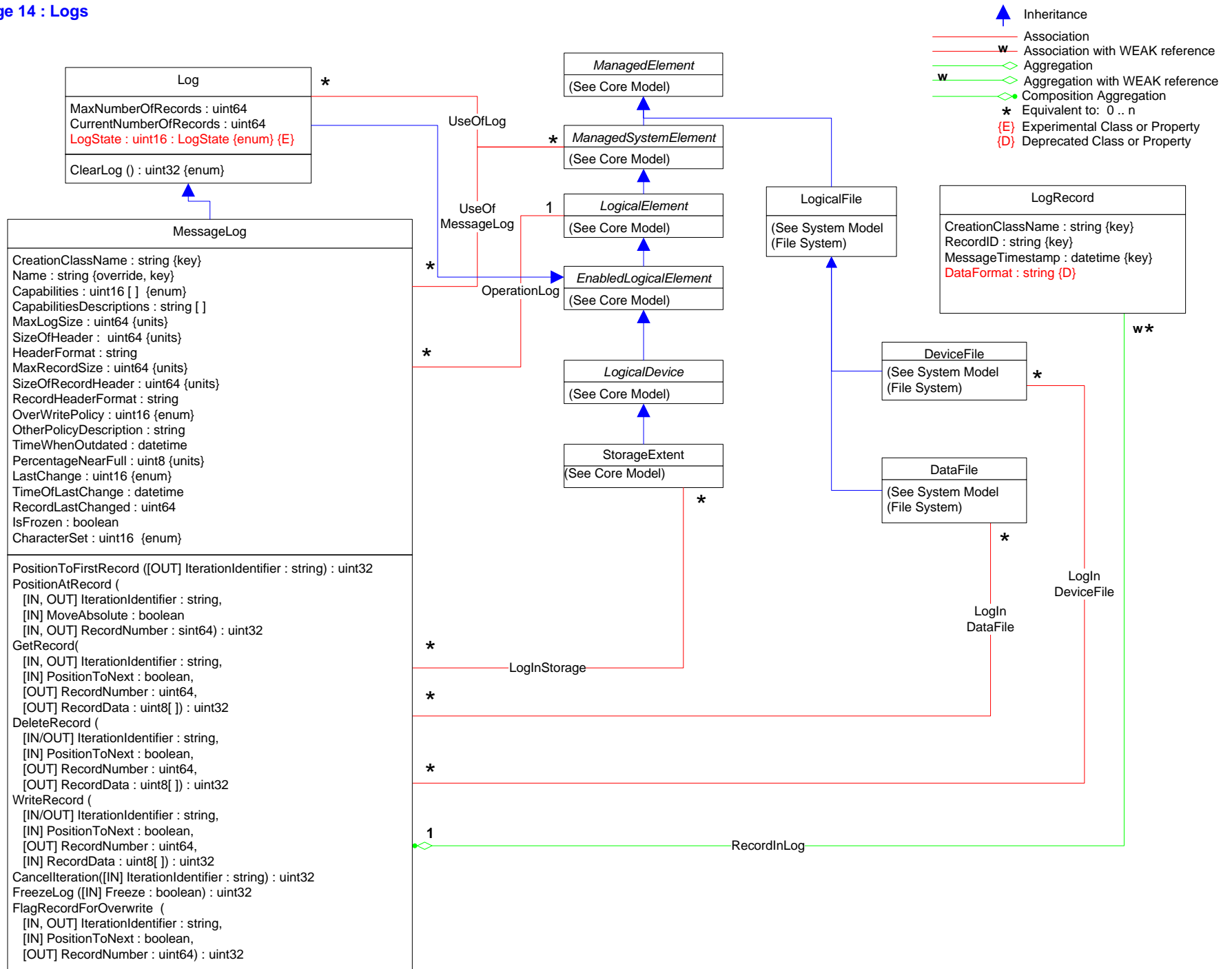

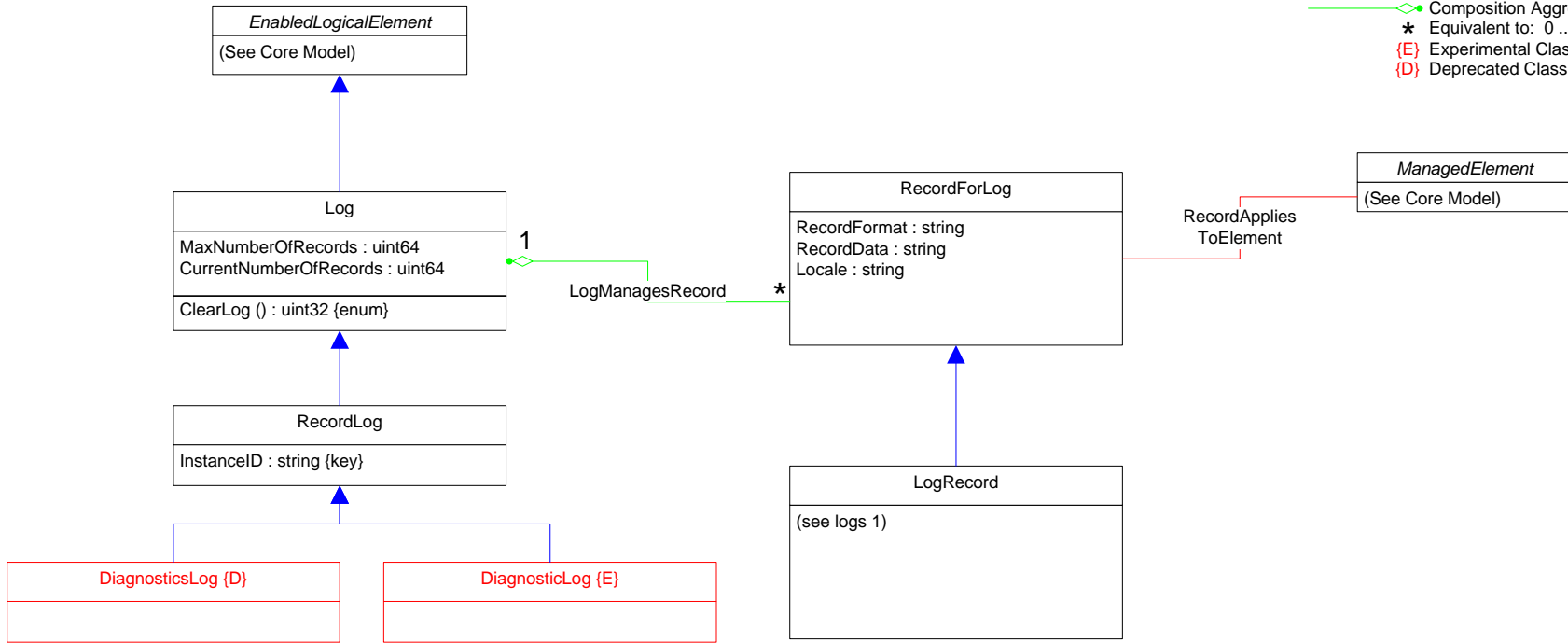
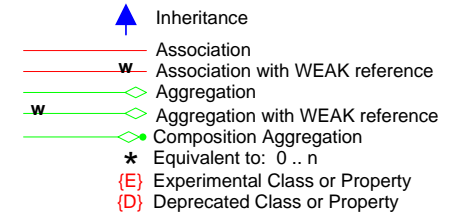

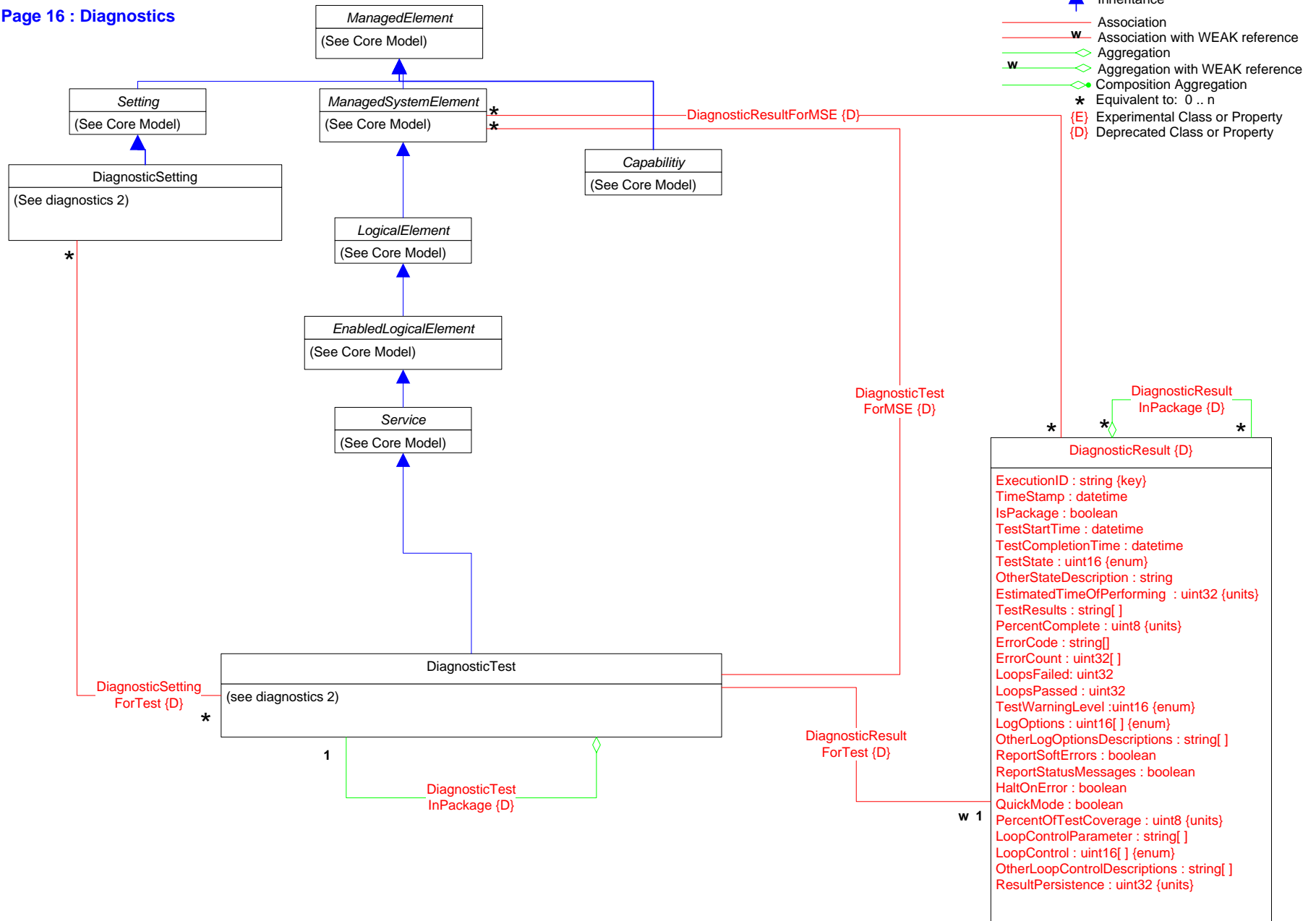

- Inheritance
- Association
- Association with WEAK reference
- Aggregation
- Aggregation with WEAK reference
- Composition Aggregation
- * Equivalent to: 0..n
- {E} Experimental Class or Property
- {D} Deprecated Class or Property

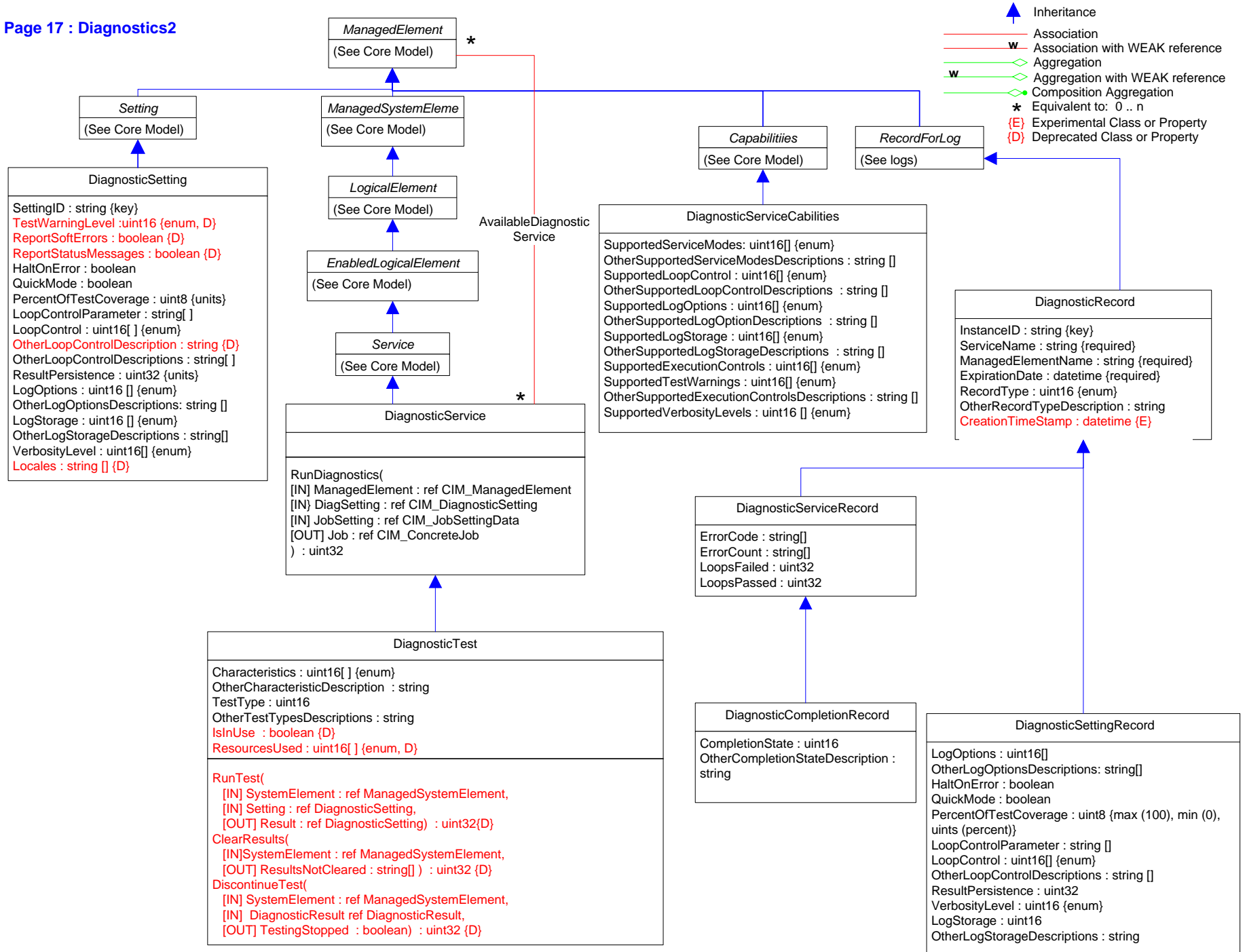

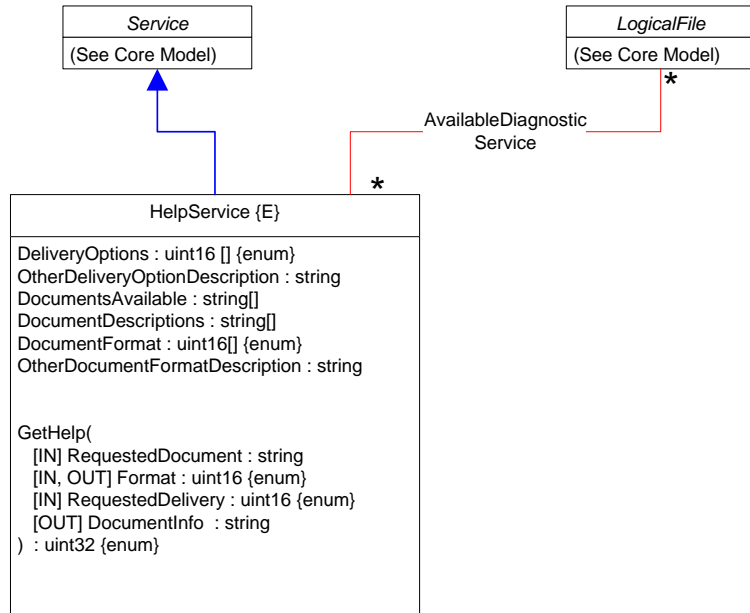

- Inheritance
- Association
- Association with WEAK reference
- Aggregation
- Aggregation with WEAK reference
- Composition Aggregation
- Equivalent to: 0 .. n
- Experimental Class or Property
- Deprecated Class or Property

Page 19 : Association Hierarchy

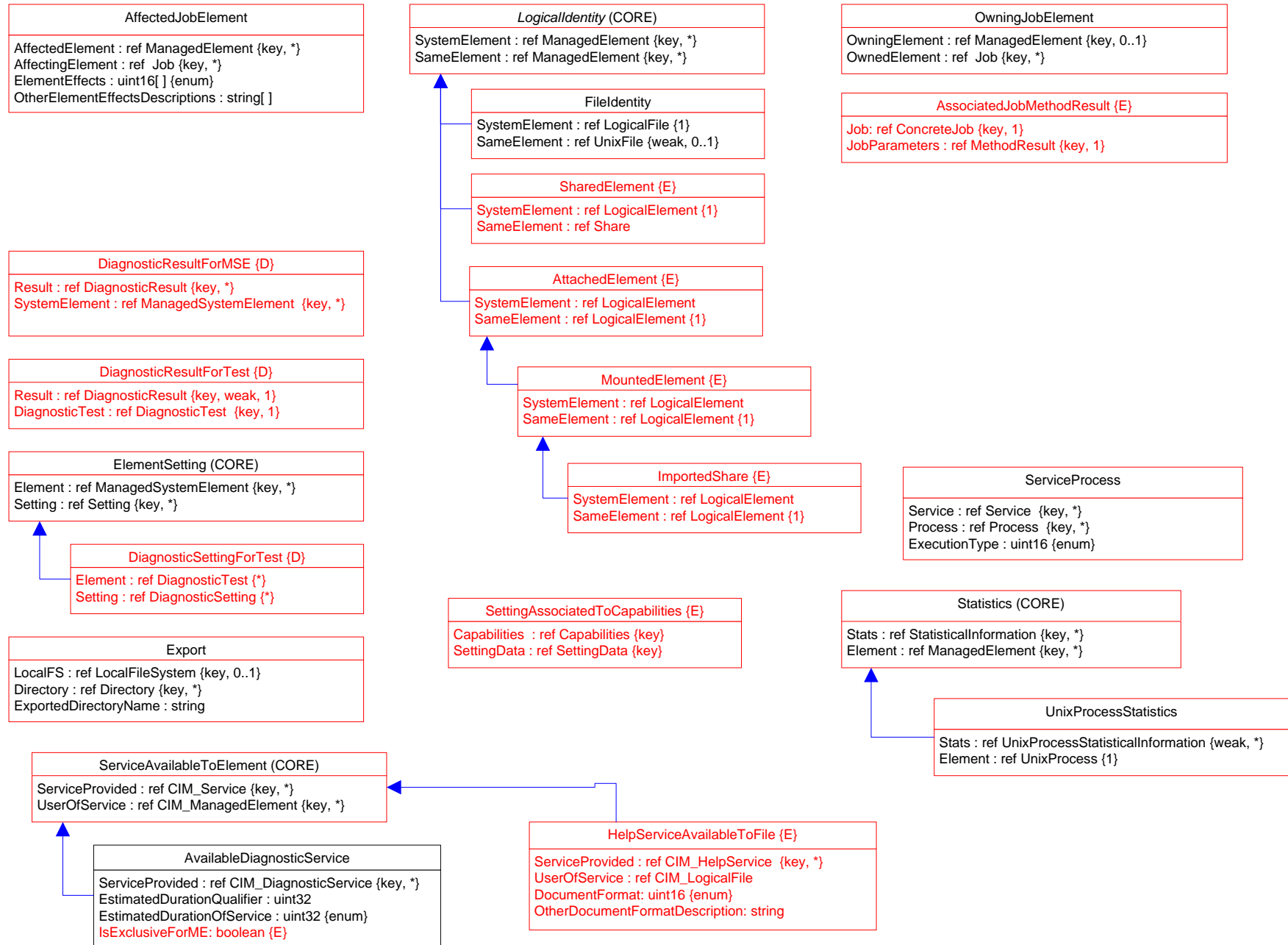

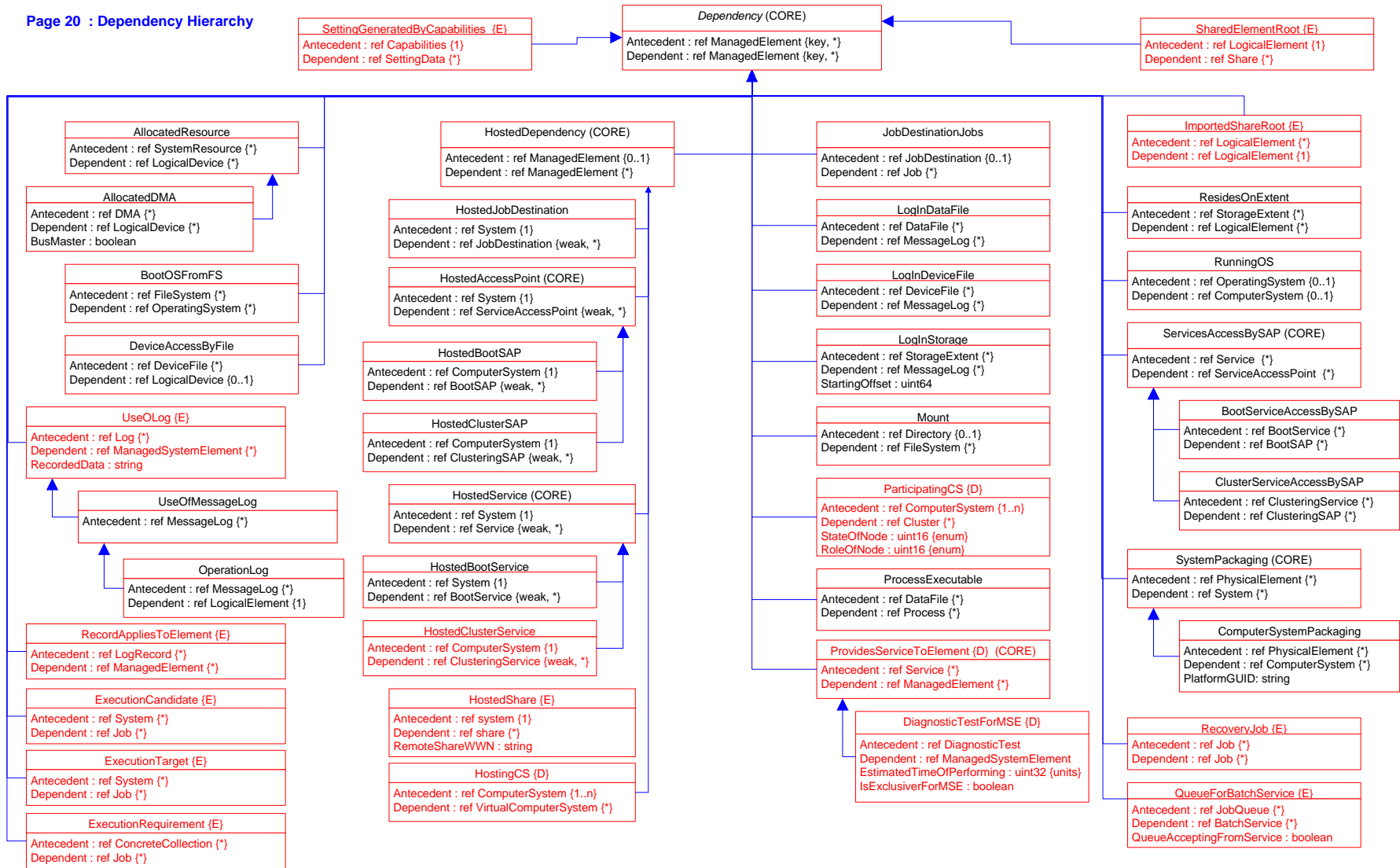

Page 21 : Aggregation Hierarchy

