

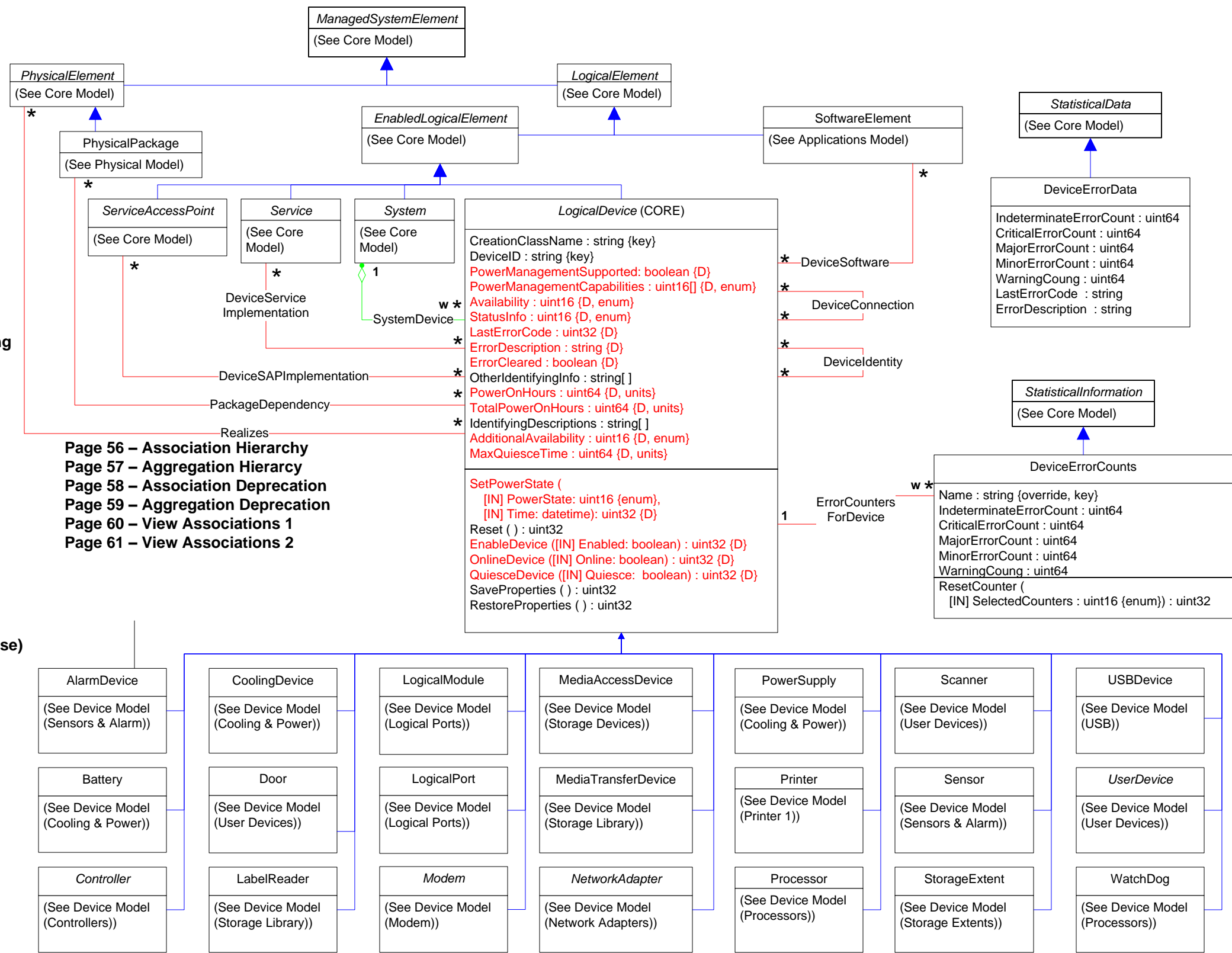





Title : Device Specification 2.33.0
Filename : CIM_Device.vsd
Author : DMTF Core Schema WG
Date : 4 June 2012

Page 1 – Overview
Page 2 – Cooling & Power
Page 3 – Processors
Page 4 – Controllers
Page 5 – Video Controllers
Page 6 – PCI Controllers
Page 7,8,9 – Logical Ports 1,2,3
Page 10 – Logical Port Group
Page 11 – Protocol Controllers
Page 12 – Network Adapters
Page 13 – Network Adapter Statistics
Page 14 – Fibre Channel
Page 15 – Fibre Channel Statistics
Page 16 – Fibre Channel Services & Zoning
Page 17 – InfiniBand
Page 18 – Storage Devices
Page 19 – Storage Multipath
Page 20,21 – Storage Extents 1,2
Page 22 – Storage Name Binding
Page 23 – SCC Extent Model
Page 24,25,26 – Storage Services 1,2,3
Page 27 – Storage Tiers 1
Page 28 – Storage Tiers 2
Page 29 – Storage Groups
Page 30,31,32 – Storage Capabilities 1,2,3
Page 33 – Storage Settings
Page 34 – Storage Statistics
Page 35 – Storage Library
Page 36,37 – Storage Views 1,2
Page 38 – User Devices (Keyboards, Mouse)
Page 39 – Displays
Page 40 – Memory
Page 41 – Modems
Page 42,43,44 – Printing 1,2,3
Page 45 – Sensors & Alarm
Page 46 – 7 USB
Page 47 – Disk Group
Page 48 – Device Sharing
Page 49 – LED
Page 50 – WiFi Services
Page 51 – VTL Statistics
Page 52 – Dependency (1) [A - Ba]
Page 53 – Dependency (2) [D - Pi]
Page 54 – Dependency (3) [Po - S]
Page 55 – Dependency (4) [Po - S]



Page 2 of 61: Cooling & Power

-  Inheritance
-  Association
-  Association with WEAK reference
-  Aggregation
-  Composition Aggregation
-  Equivalent to: 0..n
- (E) Experimental Class or Property
- (D) Deprecated Class or Property

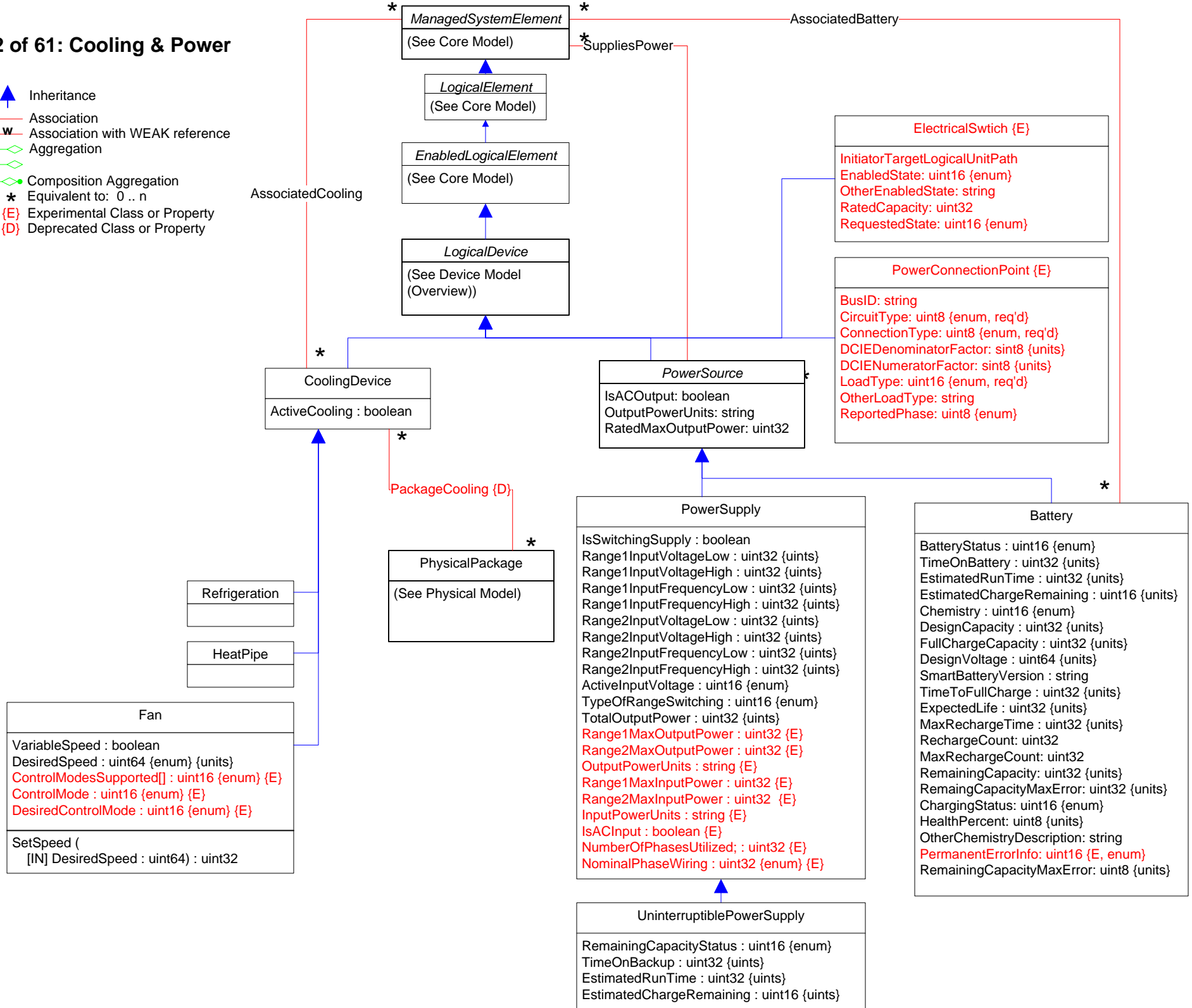

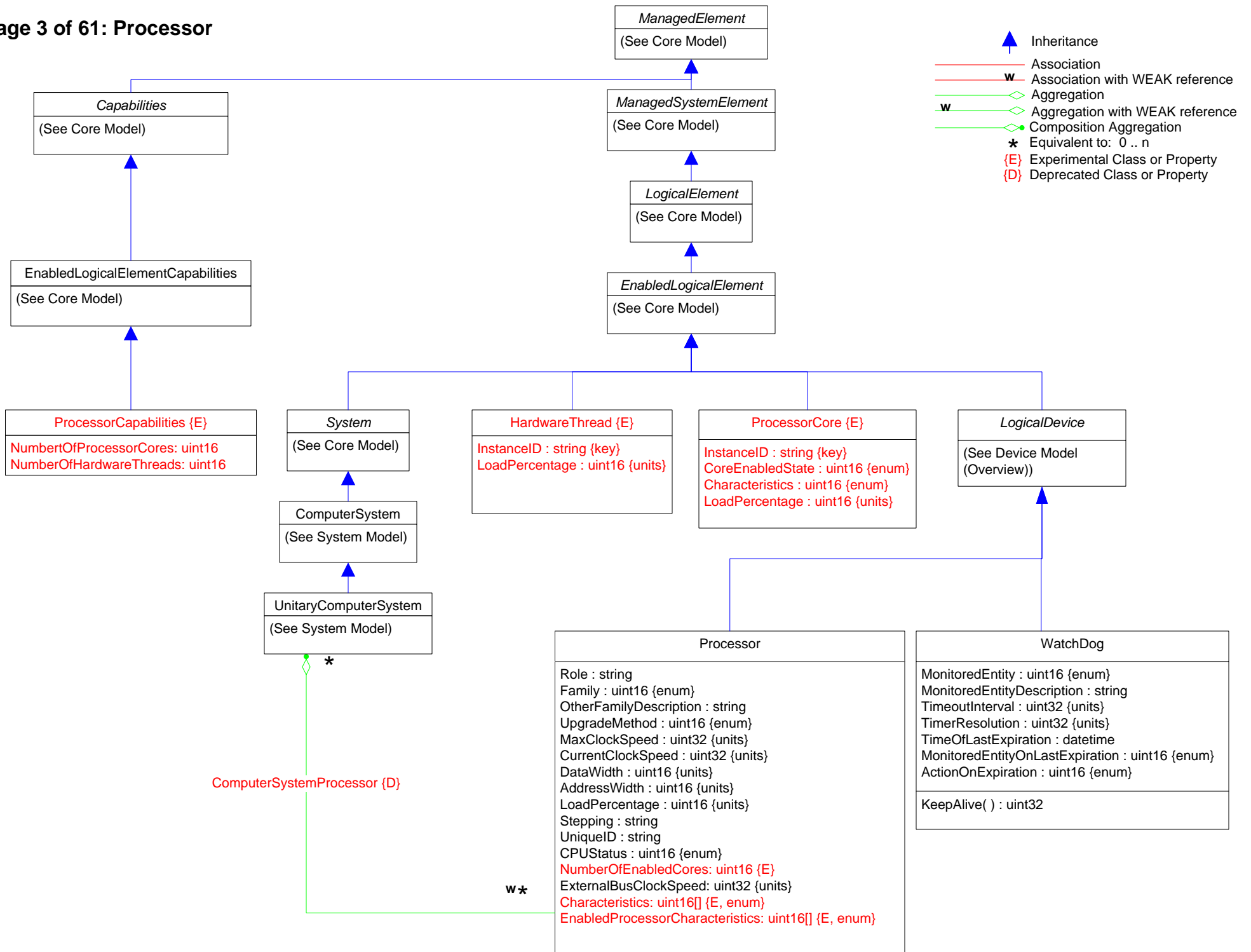





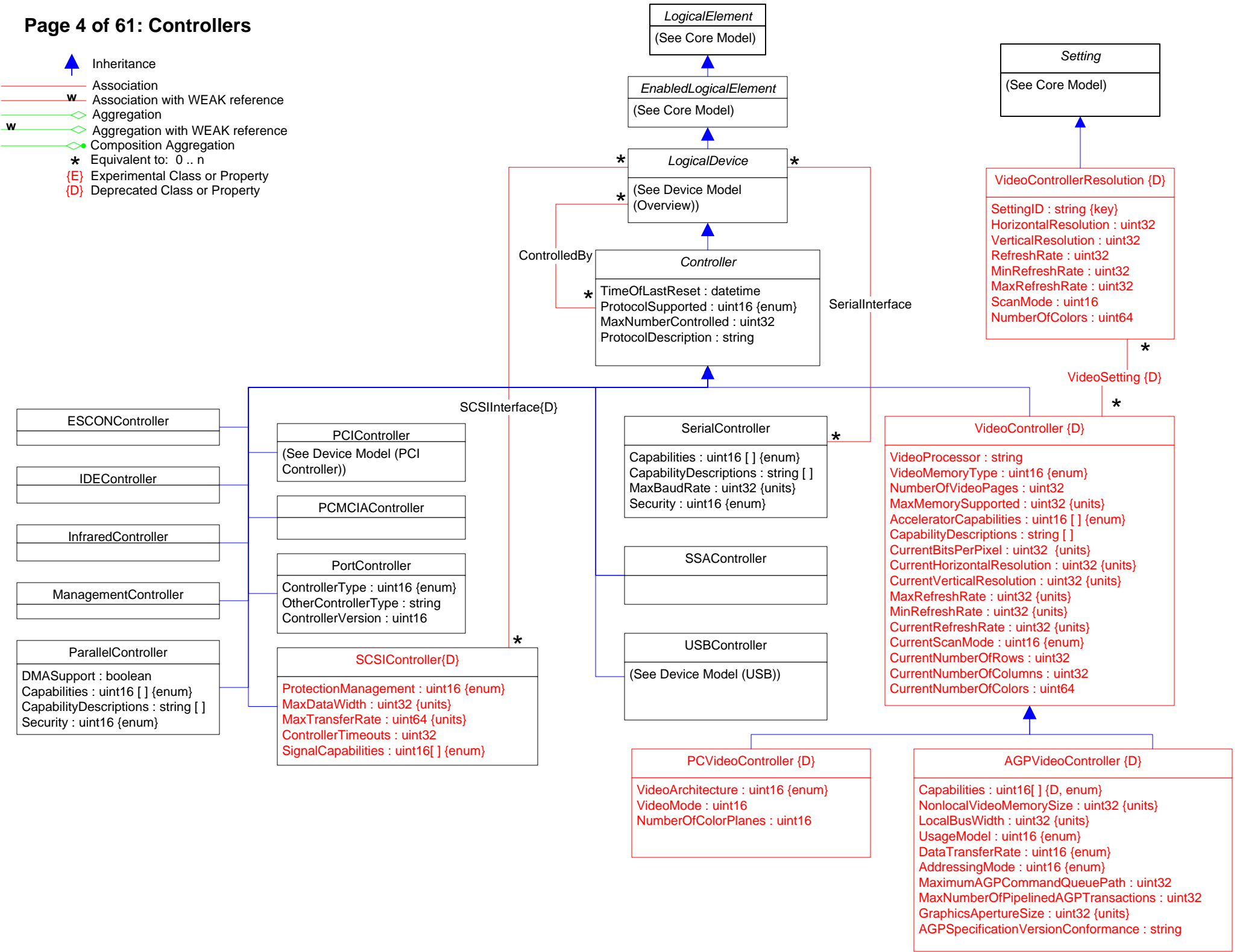



Page 4 of 61: Controllers

- Inheritance
- Association
- Association with WEAK reference
- Aggregation
- Aggregation with WEAK reference
- Composition Aggregation
- Equivalent to: 0 .. n
- Experimental Class or Property
- Deprecated Class or Property







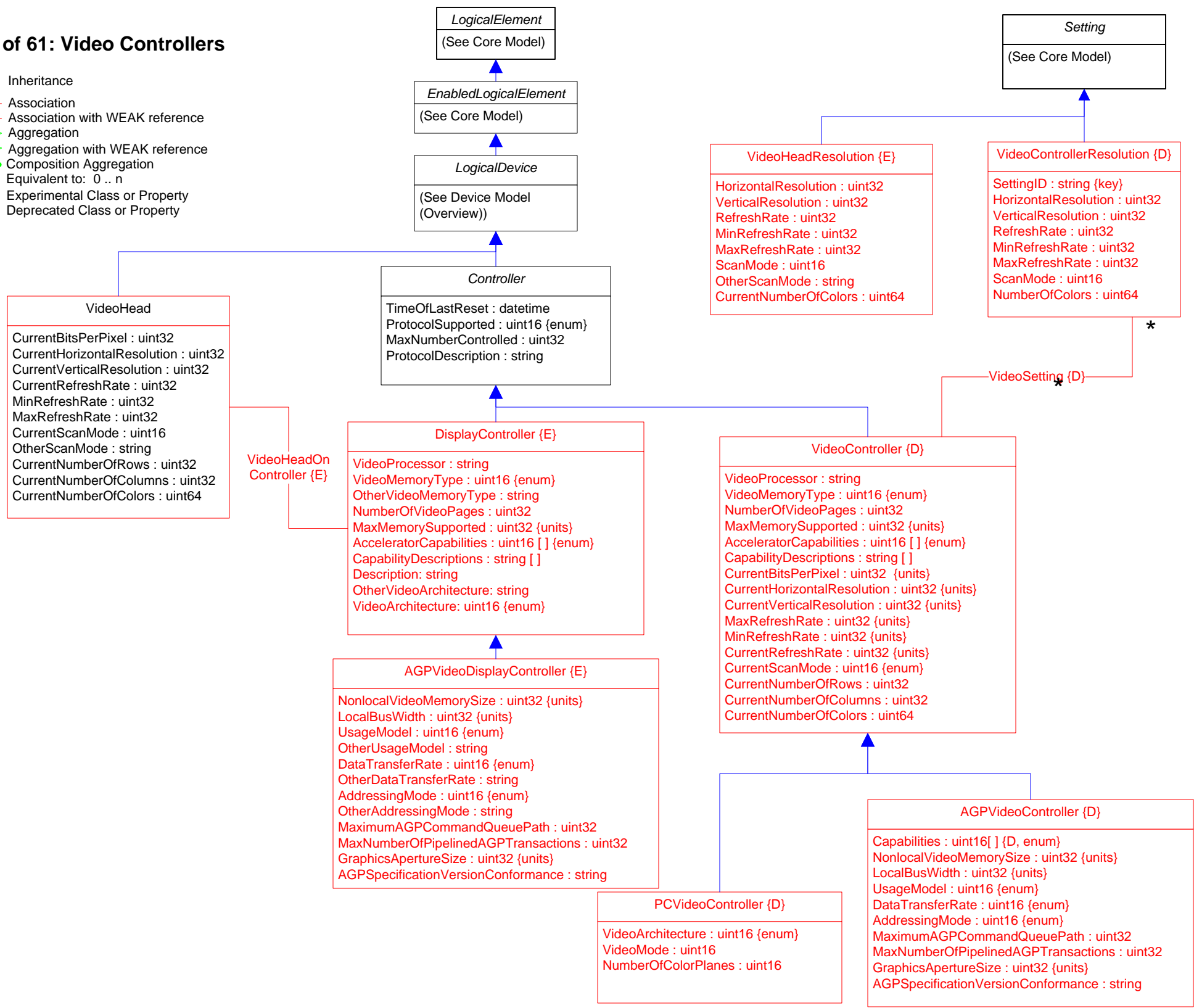



Page 5 of 61: Video Controllers

-  Inheritance
-  Association
-  Association with WEAK reference
-  Aggregation
-  Aggregation with WEAK reference
-  Composition Aggregation
-  Equivalent to: 0 .. n
-  Experimental Class or Property
-  Deprecated Class or Property



Page 6 of 61: PCI Controllers

-  Inheritance
-  Association
-  Association with WEAK reference
-  Aggregation
-  Aggregation with WEAK reference
-  Composition Aggregation
-  Equivalent to: 0..n
-  Experimental Class or Property
-  Deprecated Class or Property

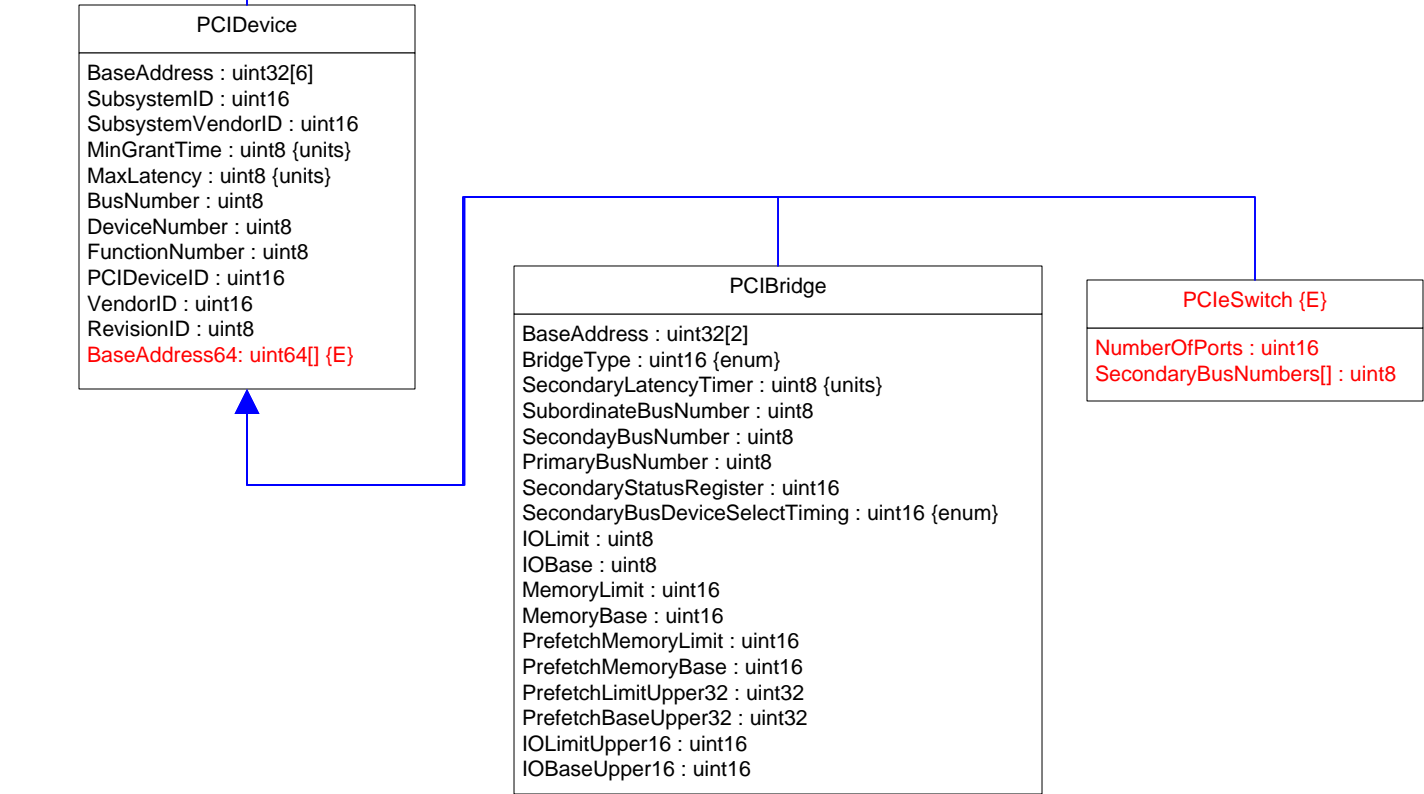
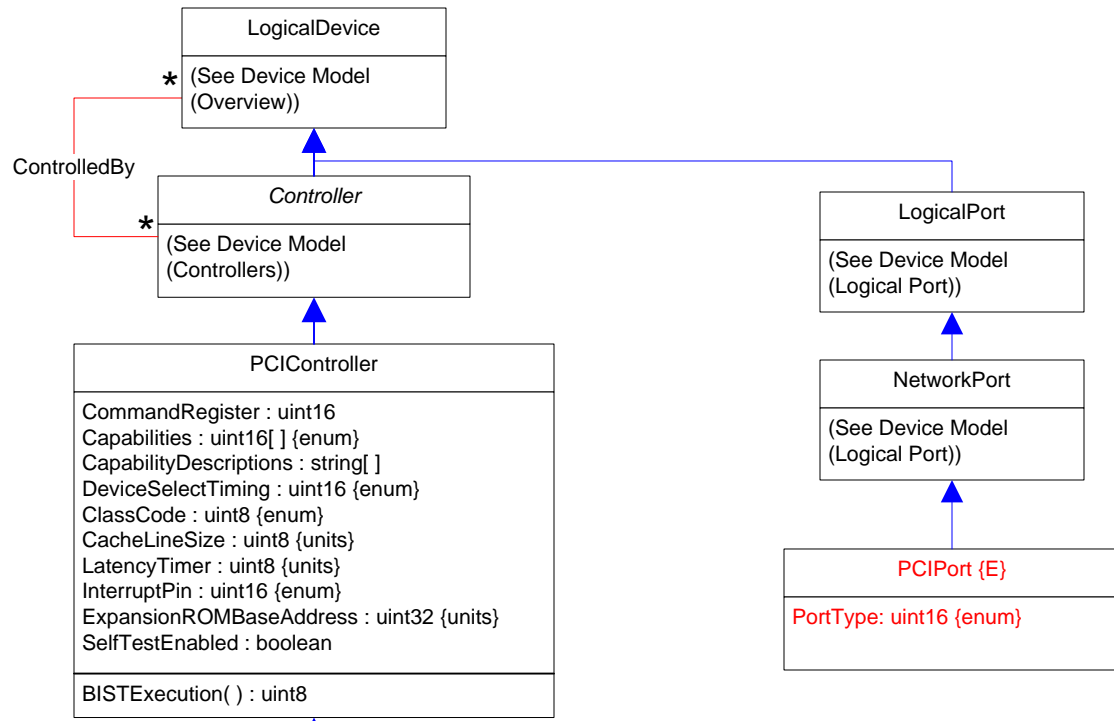
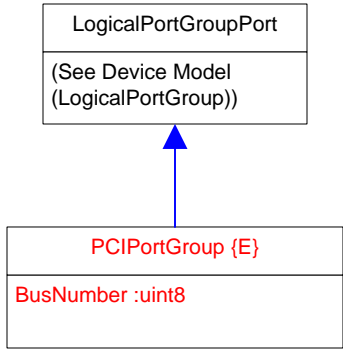

▲ Inheritance

— Association

—w Association with WEAK reference

◊ Aggregation

◊-w Aggregation with WEAK reference

◊-● Composition Aggregation







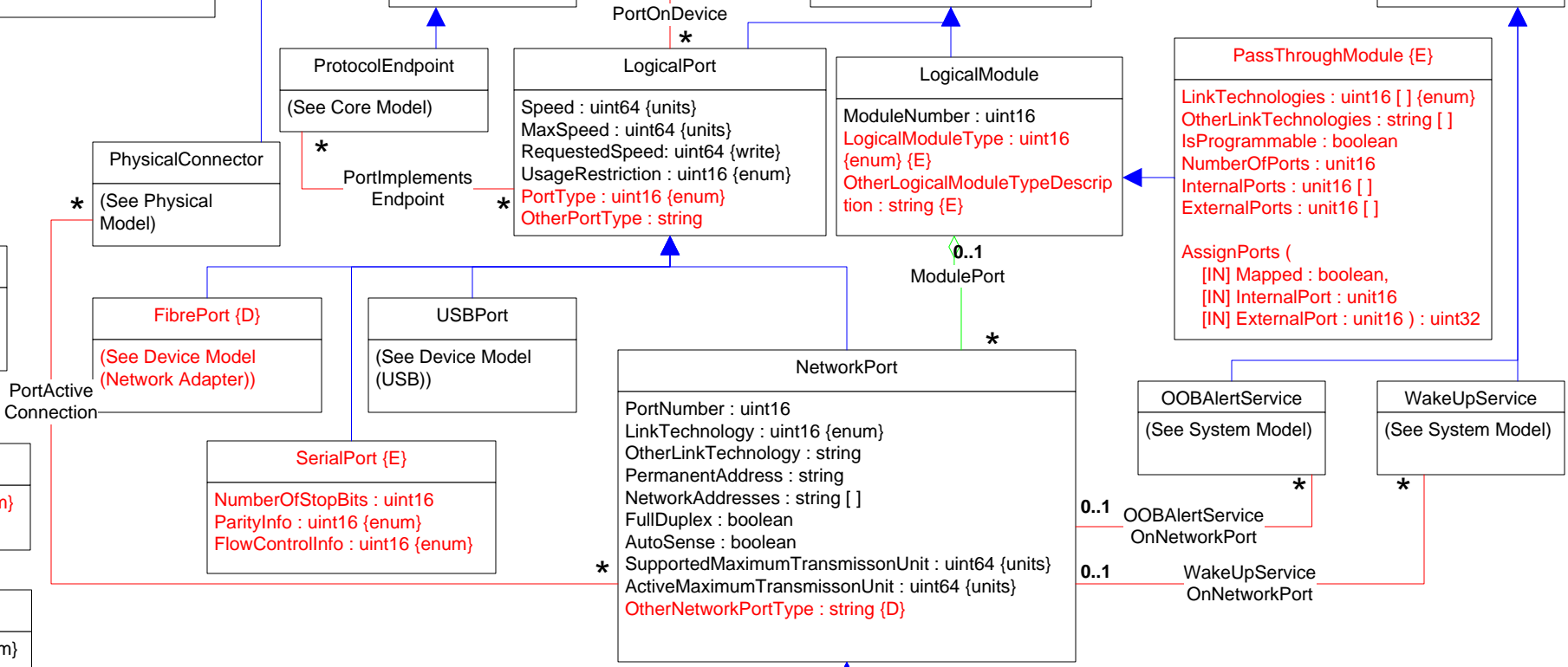
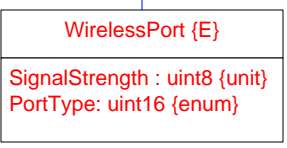
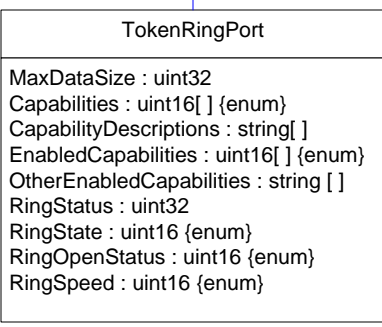
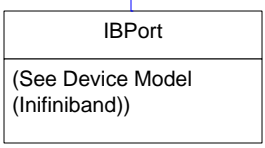
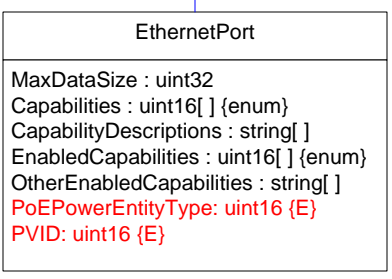
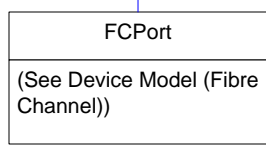
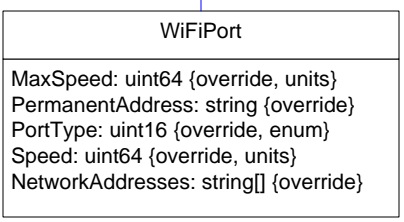
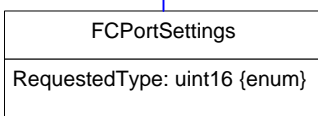
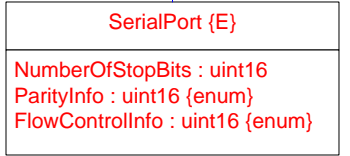
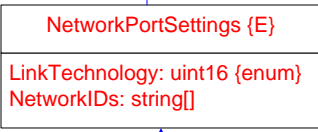
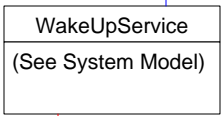
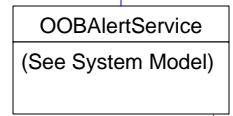
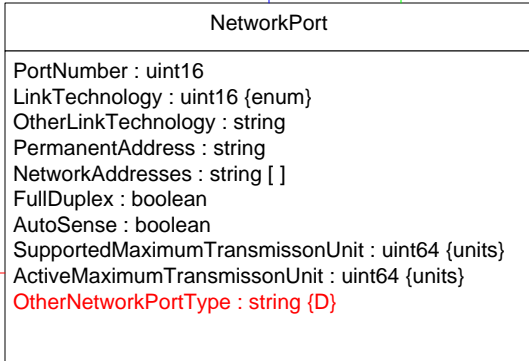
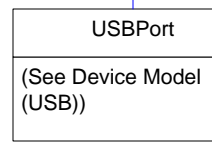
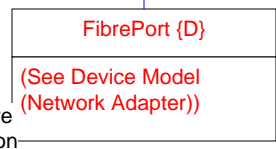
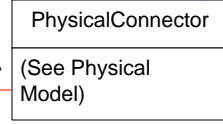
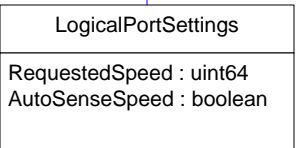
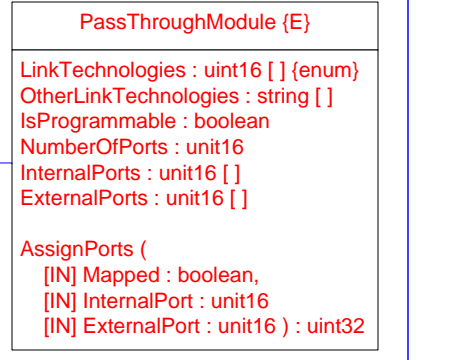
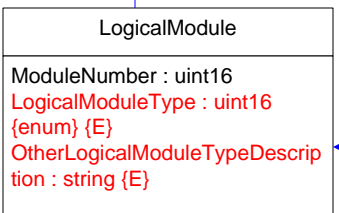
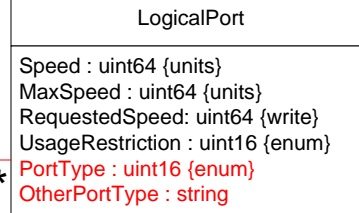
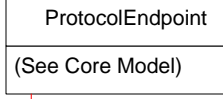
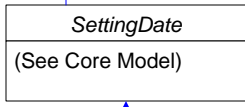
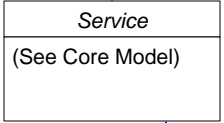
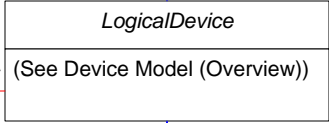
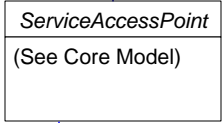
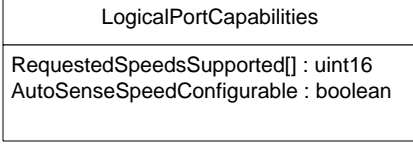
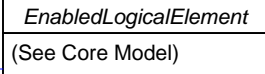
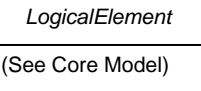
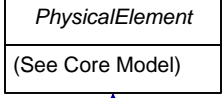
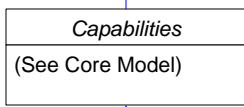
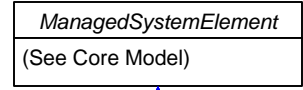

* Equivalent to: 0..n

{E} Experimental Class or Property







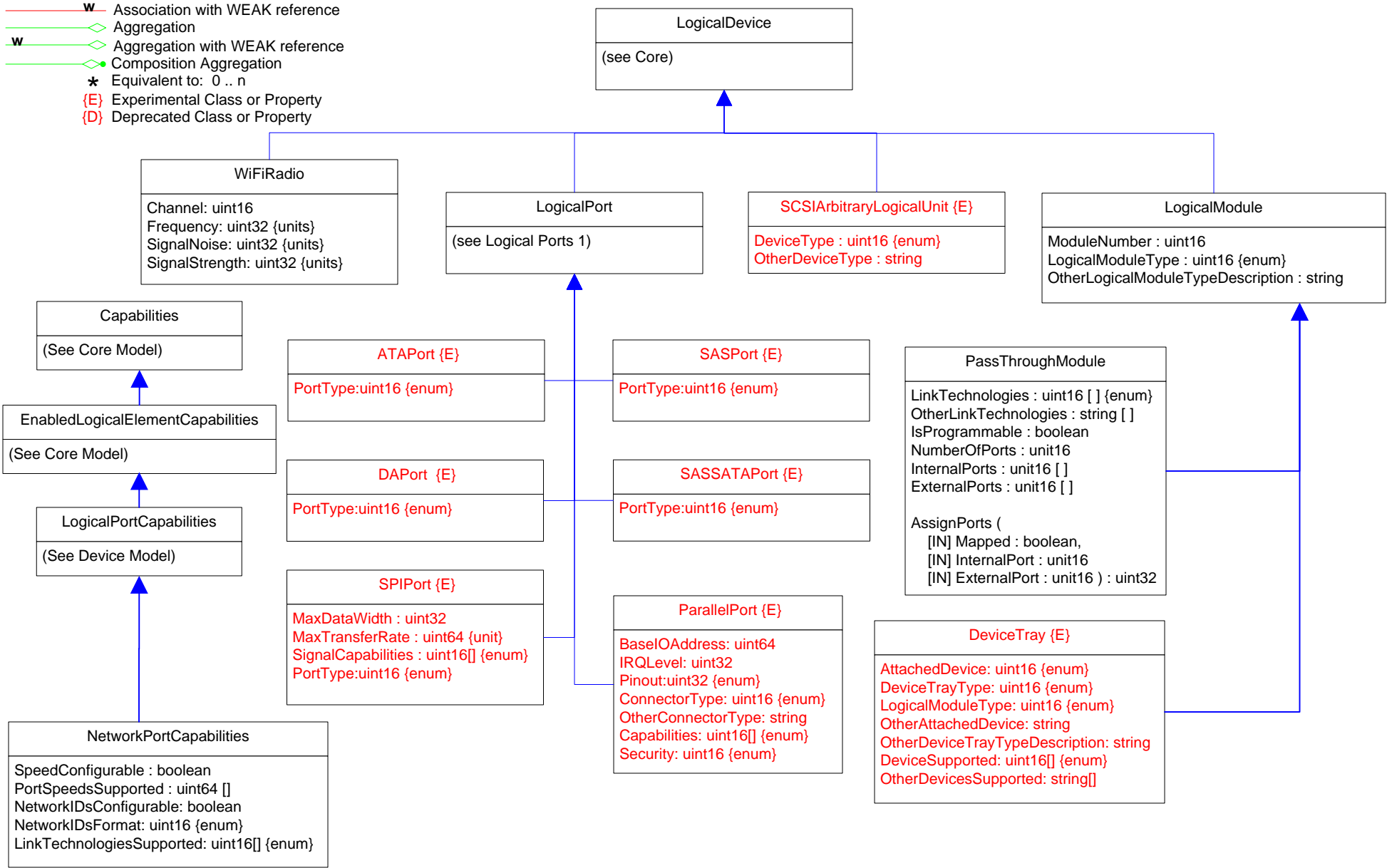

{D} Deprecated Class or Property



Page 8 of 61: Logical Ports 2

-  Inheritance
-  Association
-  Association with WEAK reference
-  Aggregation
-  Aggregation with WEAK reference
-  Composition Aggregation
-  Equivalent to: 0 .. n
-  Experimental Class or Property
-  Deprecated Class or Property



-  Inheritance
-  Association
-  Association with WEAK reference
-  Aggregation
-  Aggregation with WEAK reference
-  Composition Aggregation
-  Equivalent to: 0 .. n
-  Experimental Class or Property
-  Deprecated Class or Property

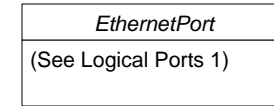

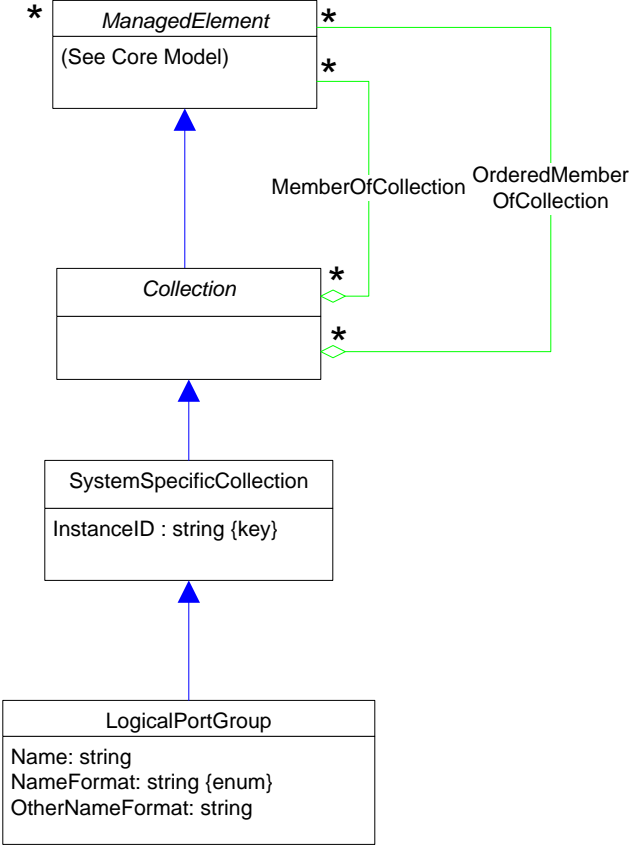



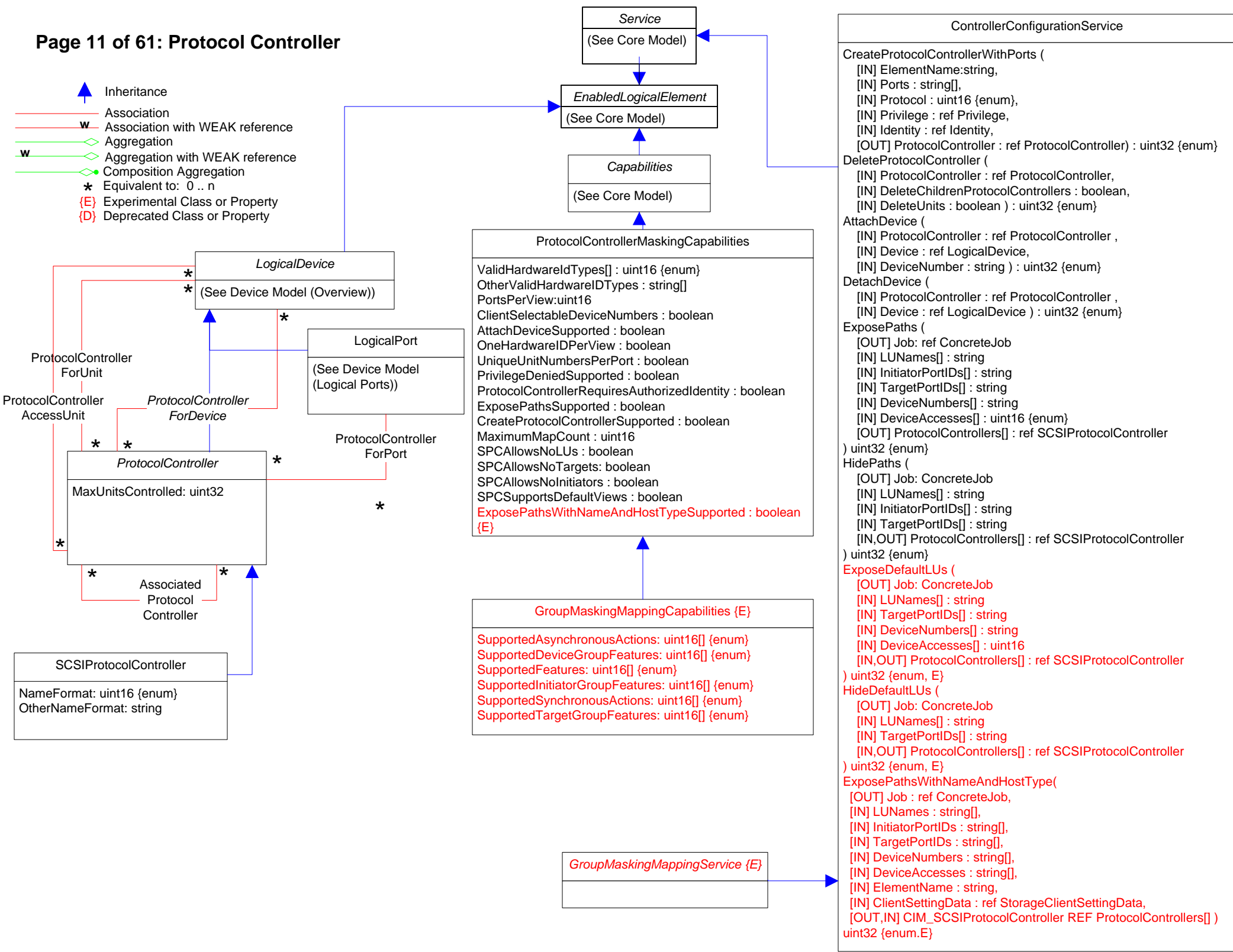

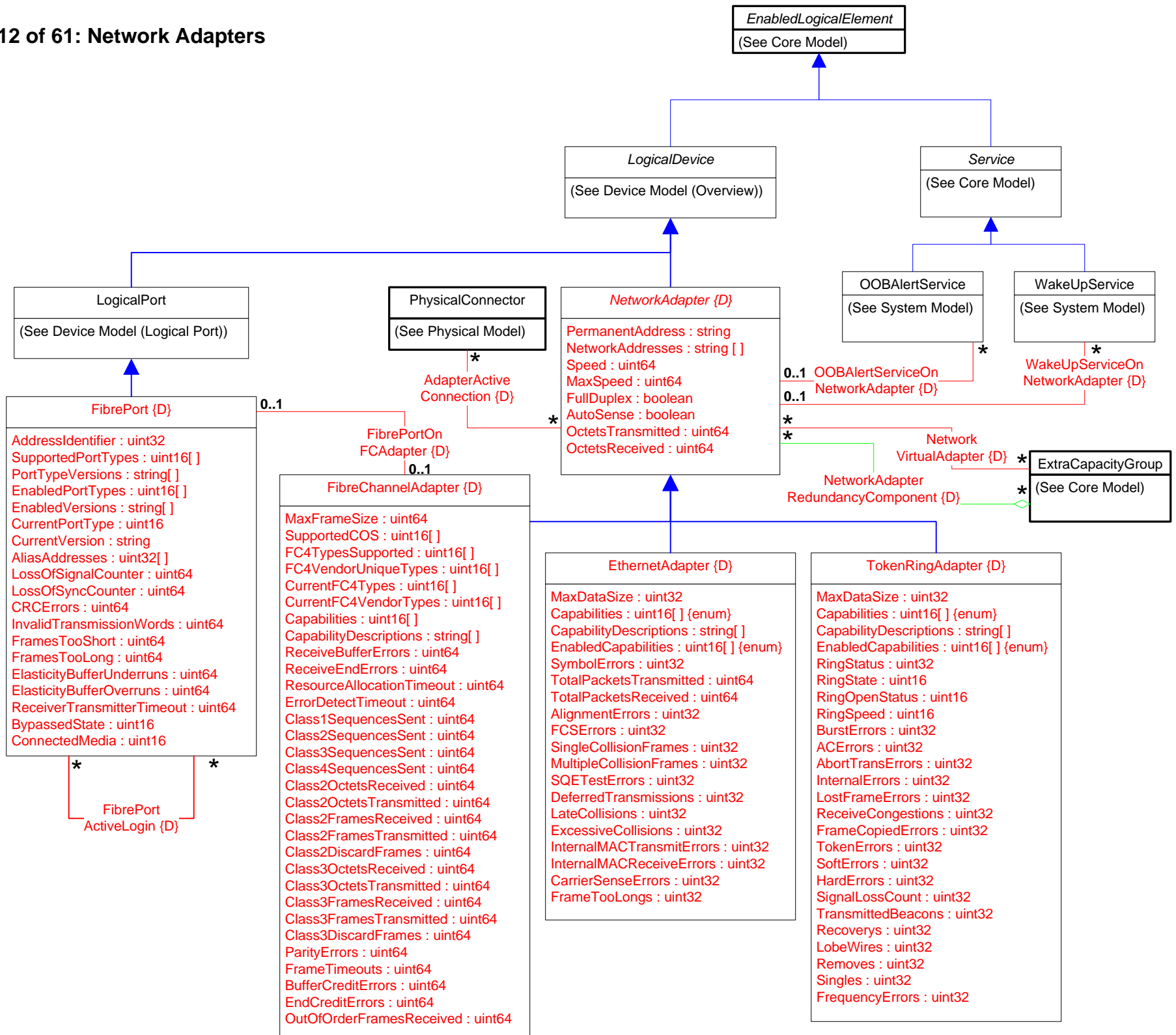

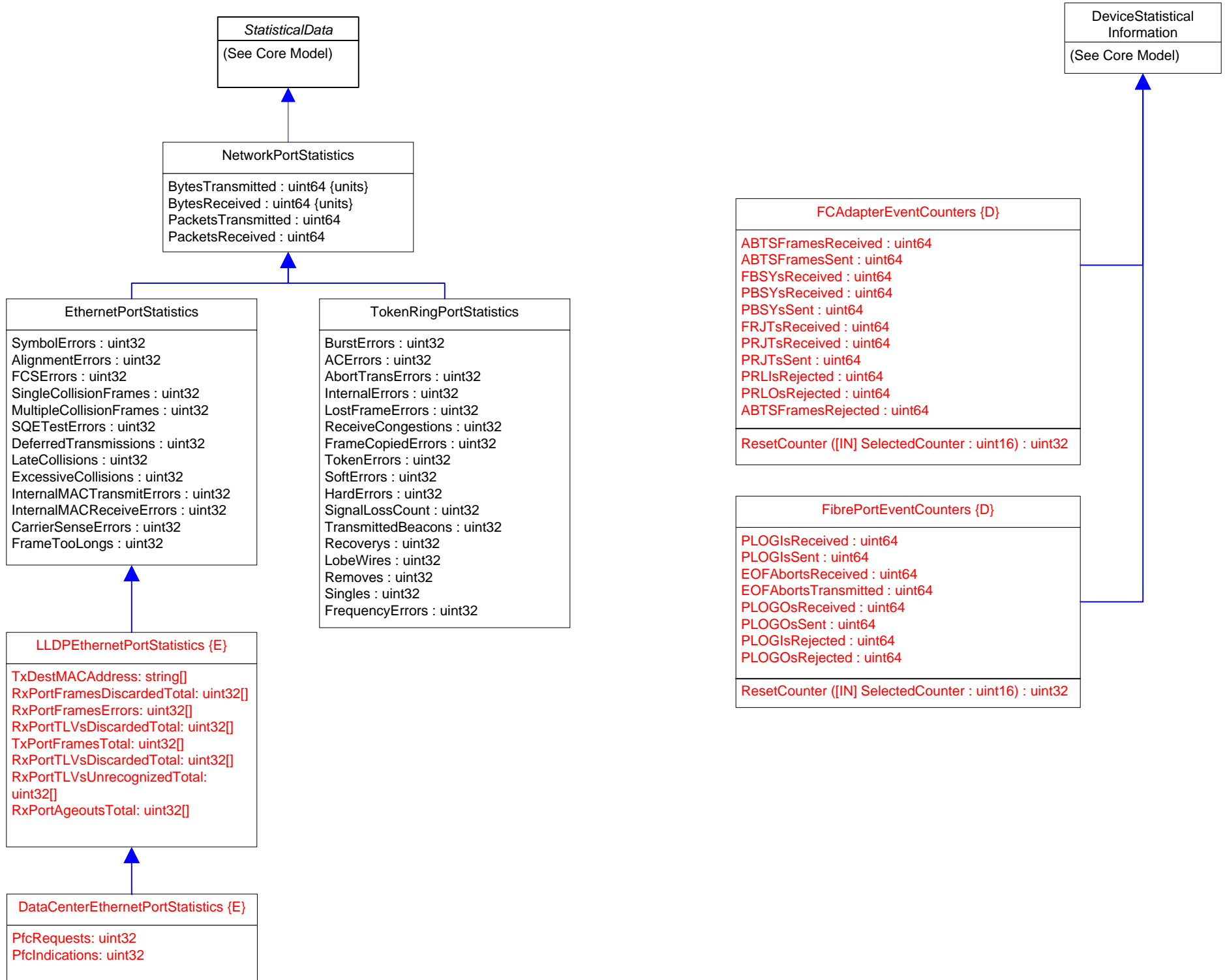



- ▲ Inheritance
- Association
- w Association with WEAK reference
- ◇ Aggregation
- w◇ Aggregation with WEAK reference
- Composition Aggregation
- * Equivalent to: 0..n
- {E} Experimental Class or Property
- {D} Deprecated Class or Property









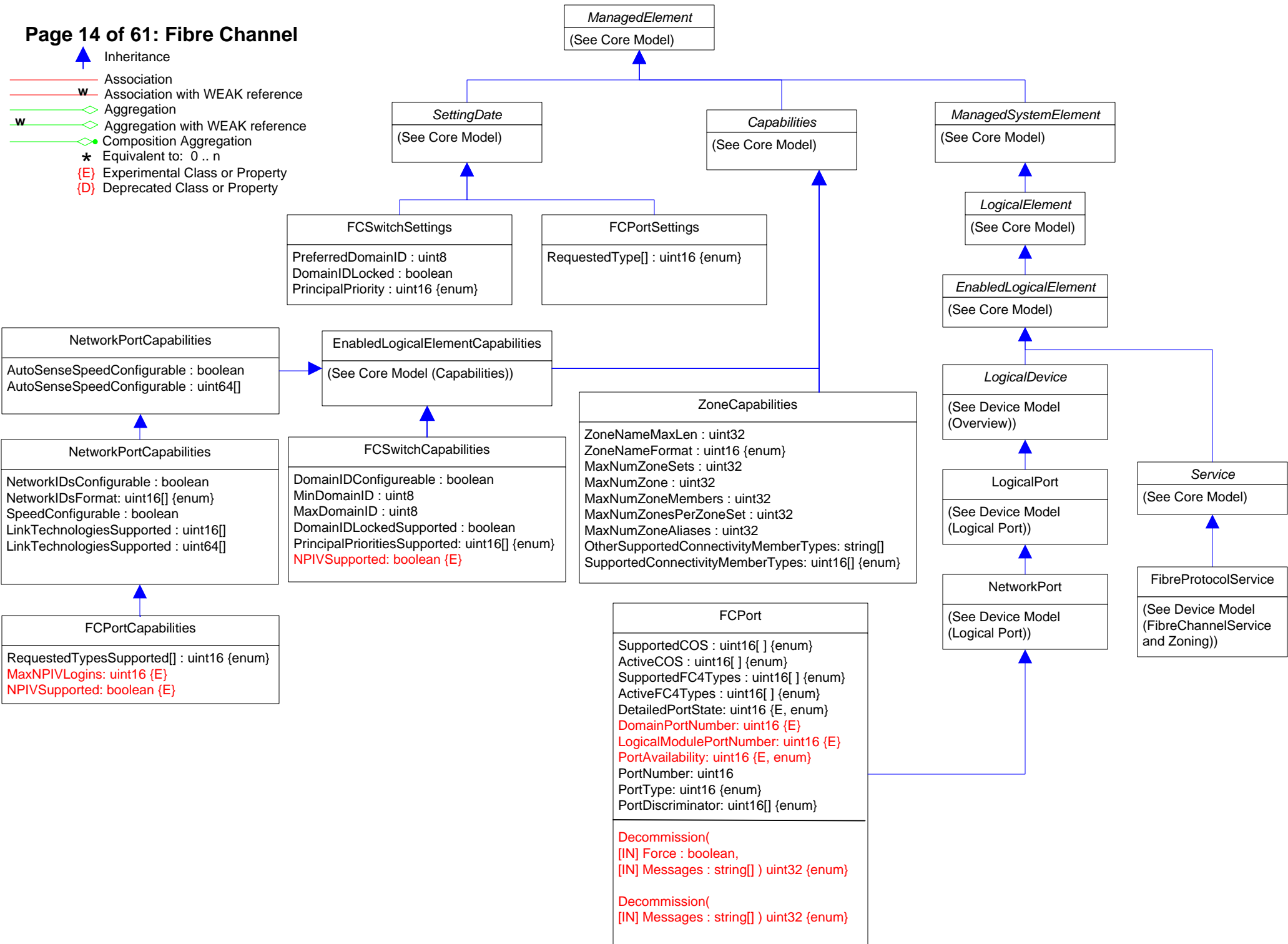

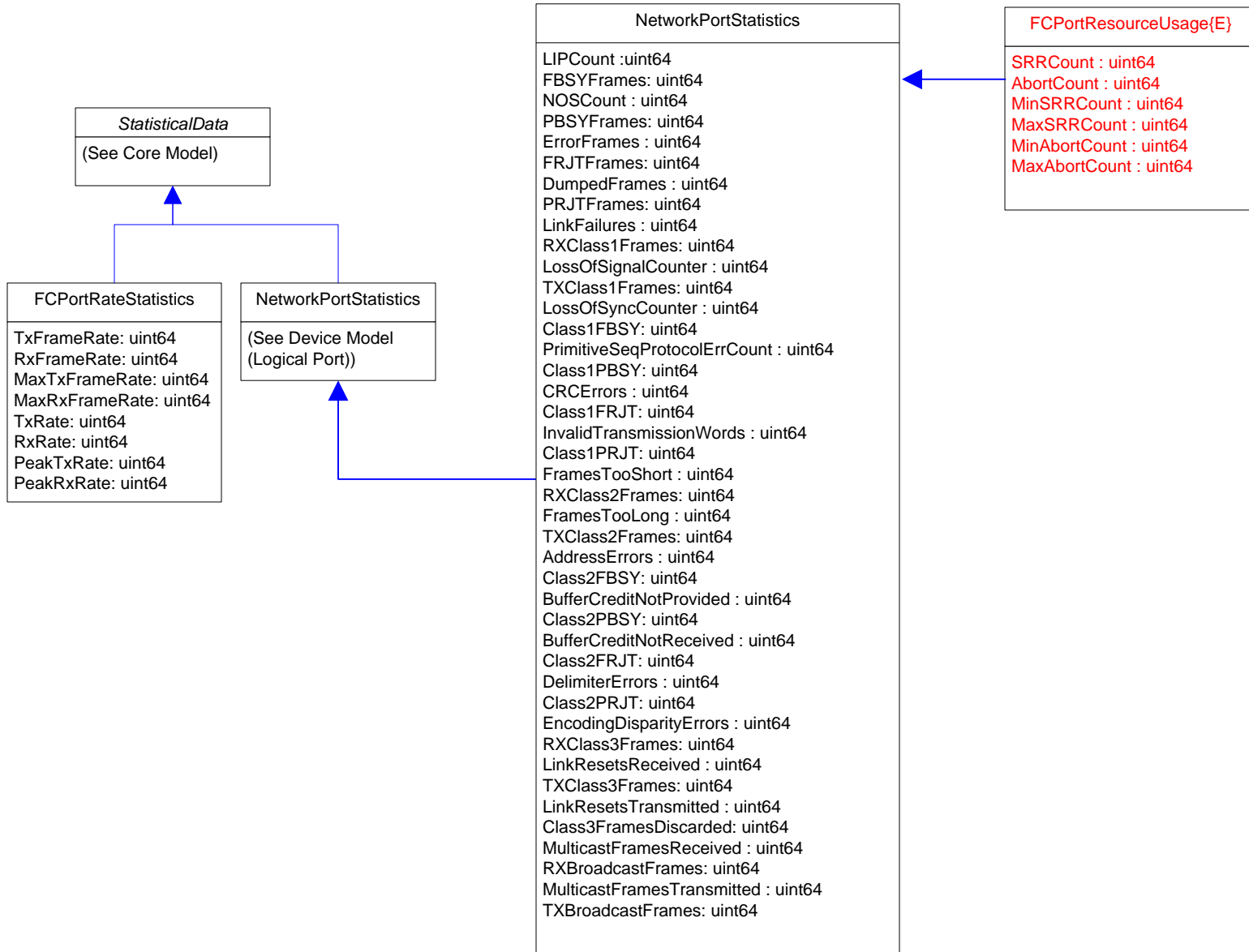





-  Inheritance
-  Association
-  Association with WEAK reference
-  Aggregation
-  Aggregation with WEAK reference
-  Composition Aggregation
-  Equivalent to: 0 .. n
-  Experimental Class or Property
-  Deprecated Class or Property









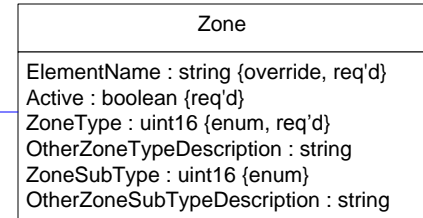
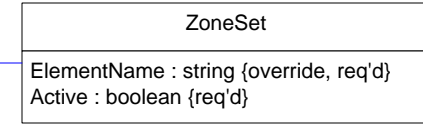
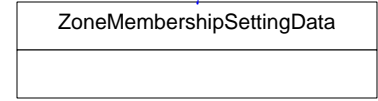
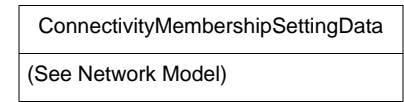
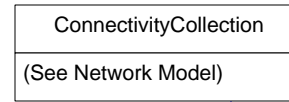
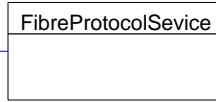
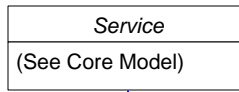
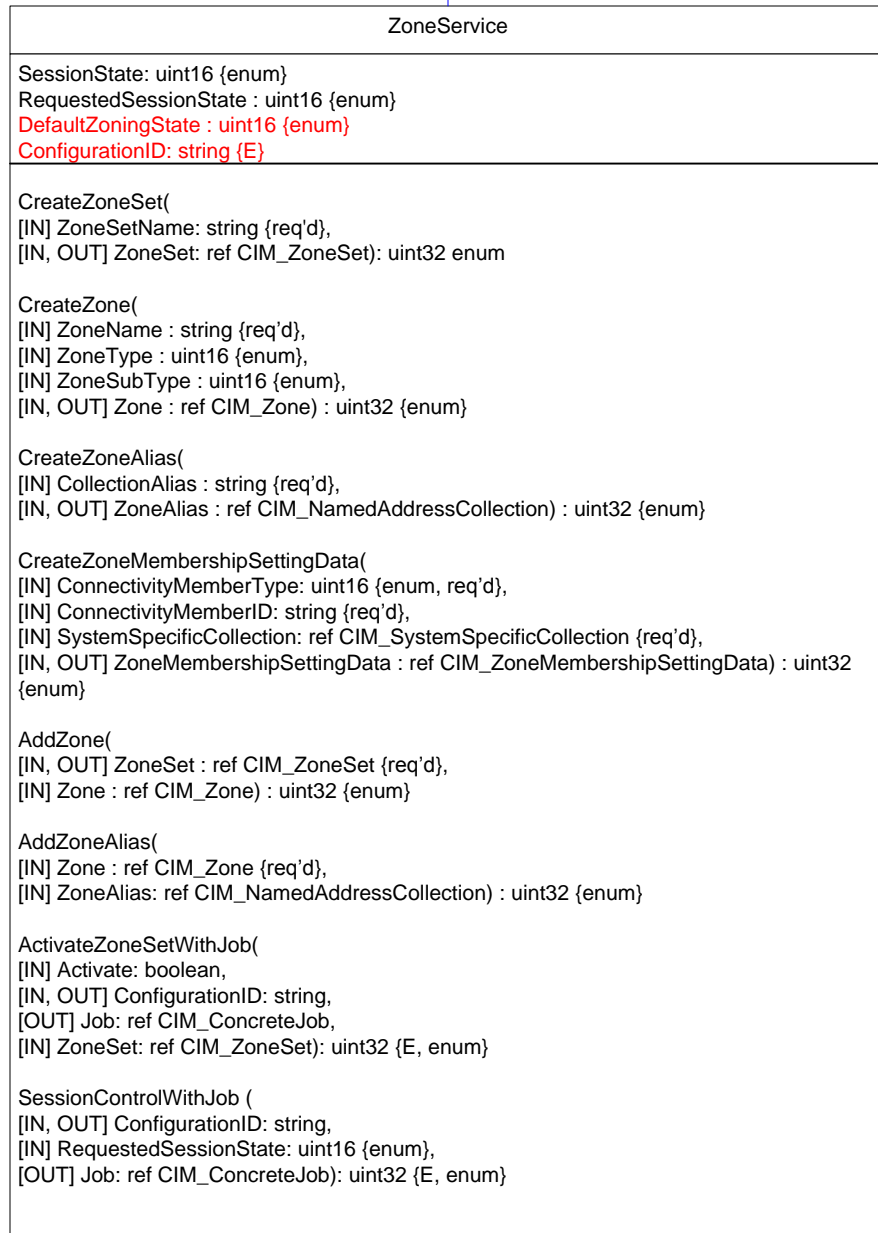











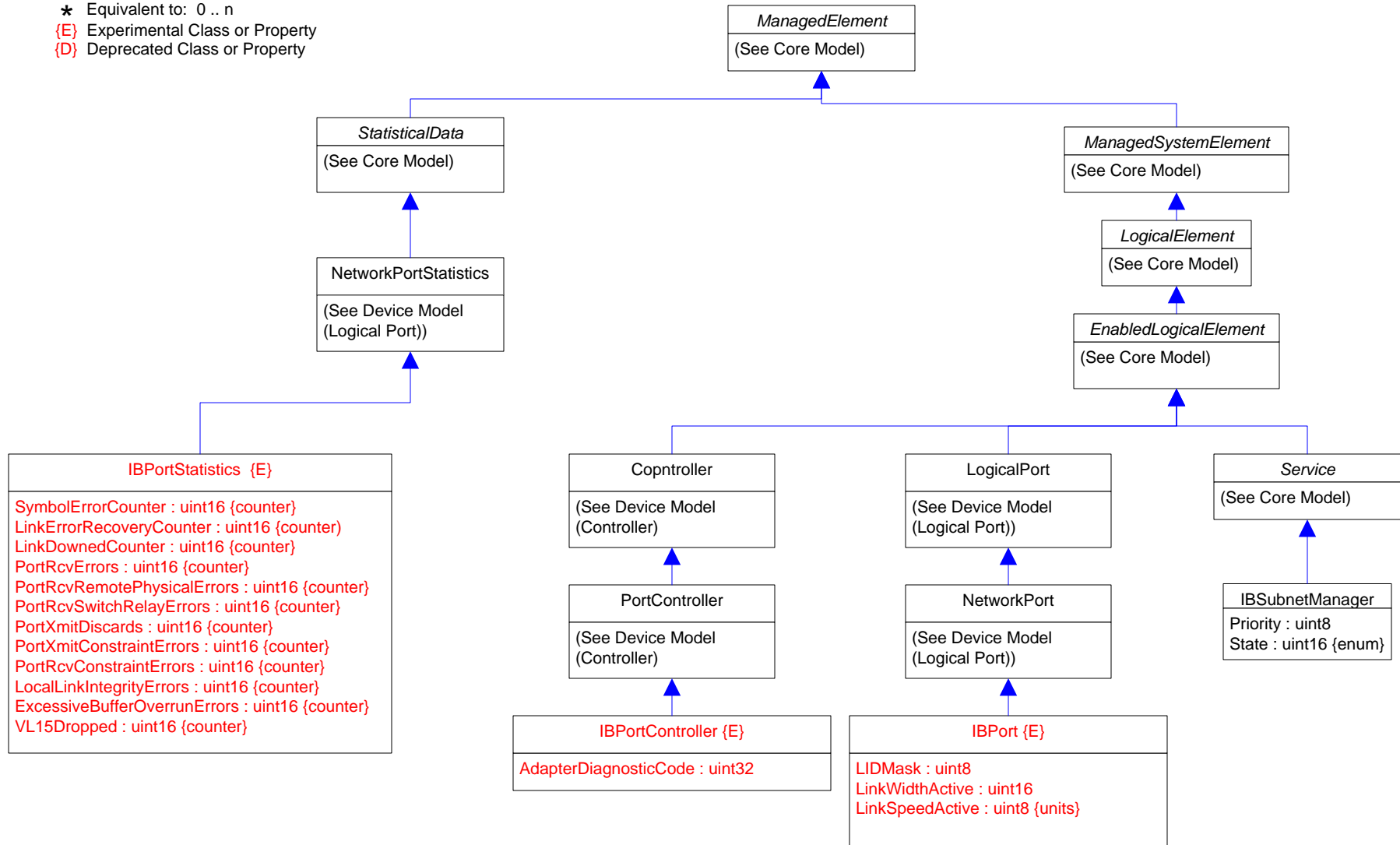

Page 16 of 61: Fibre Channel Service & Zoning

-  Inheritance
-  Association
-  Association with WEAK reference
-  Aggregation
-  Aggregation with WEAK reference
-  Composition Aggregation
-  Equivalent to: 0 .. n
-  Experimental Class or Property
-  Deprecated Class or Property









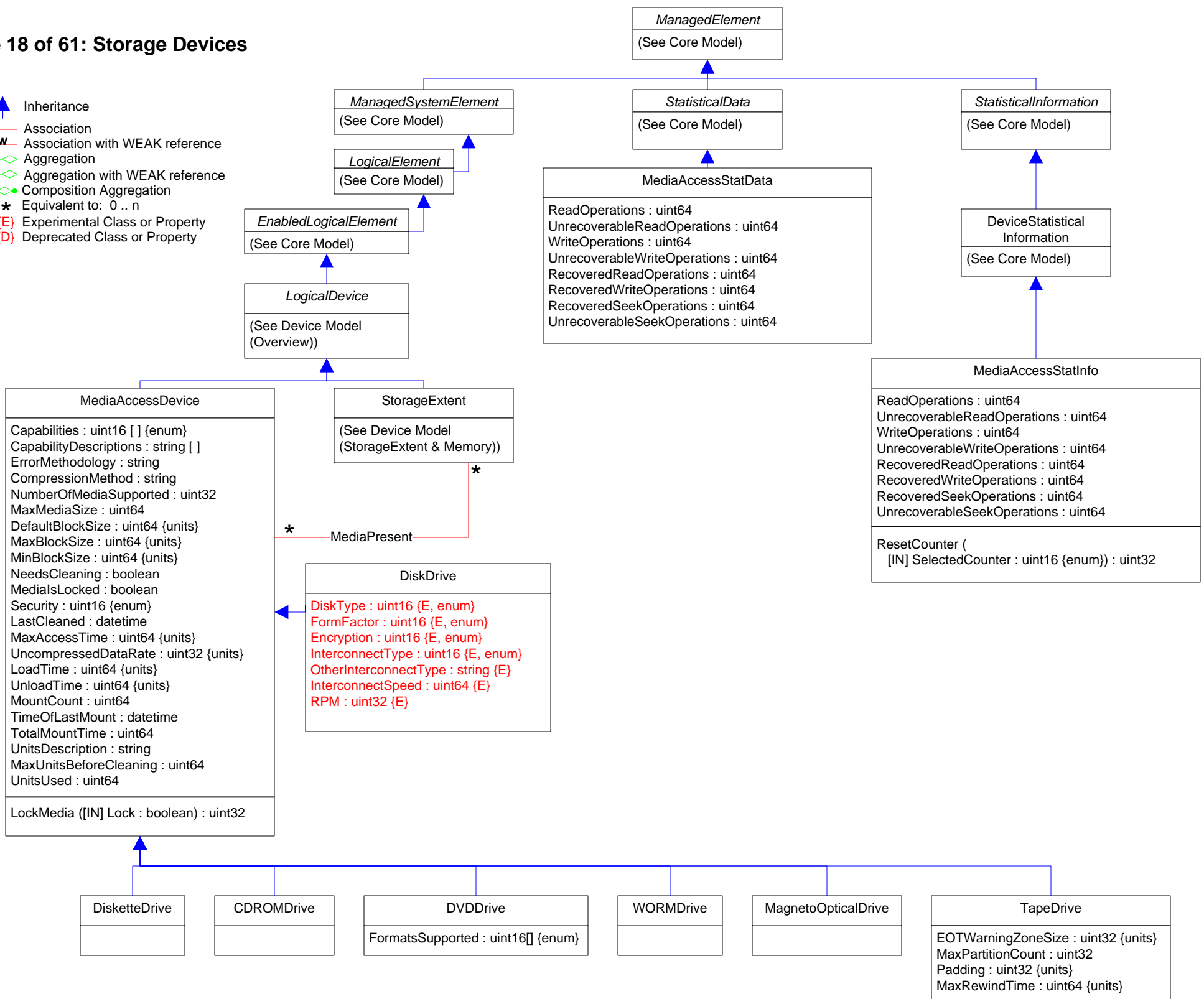

-  Inheritance
-  Association
-  Association with WEAK reference
-  Aggregation
-  Aggregation with WEAK reference
-  Composition Aggregation
-  Equivalent to: 0 .. n
-  Experimental Class or Property
-  Deprecated Class or Property



-  Inheritance
-  Association
-  Association with WEAK reference
-  Aggregation
-  Aggregation with WEAK reference
-  Composition Aggregation
-  Equivalent to: 0..n
-  Experimental Class or Property
-  Deprecated Class or Property



Page 19 of 61: Storage Multipath

-  Inheritance
-  Association
-  Association with WEAK reference
-  Aggregation
-  Aggregation with WEAK reference
-  Composition Aggregation
-  Equivalent to: 0 .. n
-  Experimental Class or Property
-  Deprecated Class or Property

SystemSpecificCollection
(See Core Model)

Service
(See Core Model)

Capabilities
(See Core Model)

SCSITargetPortGroup

AccessState : uint16 {enum}
 SupportsLuAssignment : boolean
 ExplicitFailover : boolean
 Preferred : boolean
 Identifier : uint16

SCSIPathConfigurationService

SetTPGAccess (
 [IN] LogicalUnit : ref LogicalDevice
 [IN] TargetPortGroups : ref SCSITargetPortGroup []
 [IN] AccessStates {enum}
) : uint32 {enum}
 SetLoadBalanceAlgorithm (
 [IN] LogicalDevice : ref LogicalDevice
 [IN] LoadBalanceAlgorithm : uint16 {enum}
 [IN] OtherLoadBalanceAlgorithmDescription : string
) : uint32 {enum}
 AssignLogicalUnitToPortGroup (
 [IN] LogicalUnit : ref LogicalDevice
 [IN] TargetPortGroup : ref SCSITargetPortGroup
) : uint32 {enum}
 SetOverridePath (
 [IN] Path : ref SCSIInitiatorTargetLogicalUnitPath
) : uint32 {enum}
 CancelOverridePath (
 [IN] LogicalUnit: ref LogicalDevice
) : uint32 {enum}

SCSIMultipathConfigurationCapabilities

SupportedLoadBalanceTypes : uint16 {enum}
 OtherSupportedLoadBalanceAlgorithmNames : string []
 OtherSupportedLoadBalanceVendorNames : string []
 CanSetTPGAccess : boolean
 CanOverridePaths : boolean
 ExposesPathDeviceFiles : boolean
 DeviceNameFilespace : string
 OnlySupportsSpecifiedProducts : boolean
 MaximumWeight : uint32
 PollingRateMax : uint32
 CurrentPollingRate: uint32
 AutoFailbackSupport : uint16 {Enum}
 AutoFailbackEnabled : boolean
 DefaultLoadBalanceType : uint16 {enum}

SettingData
(See Core Model)

SCSIMultipathSettings

Asymmetric: boolean
 AutoFailbackEnabled: uint16 {enum}
 CurrentLoadBalanceType: uint16 {enum}
 CurrentPollingRate: uint32
 OtherCurrentLoadBalanceType: string
 PollingRateMax: uint32

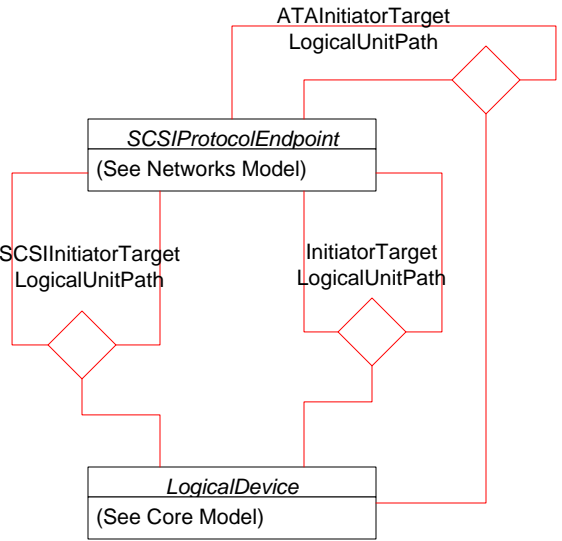

- Inheritance
- Association
- Association with WEAK reference
- Aggregation
- Aggregation with WEAK reference
- Composition Aggregation
- Equivalent to: 0..n
- Experimental Class or Property
- Deprecated Class or Property

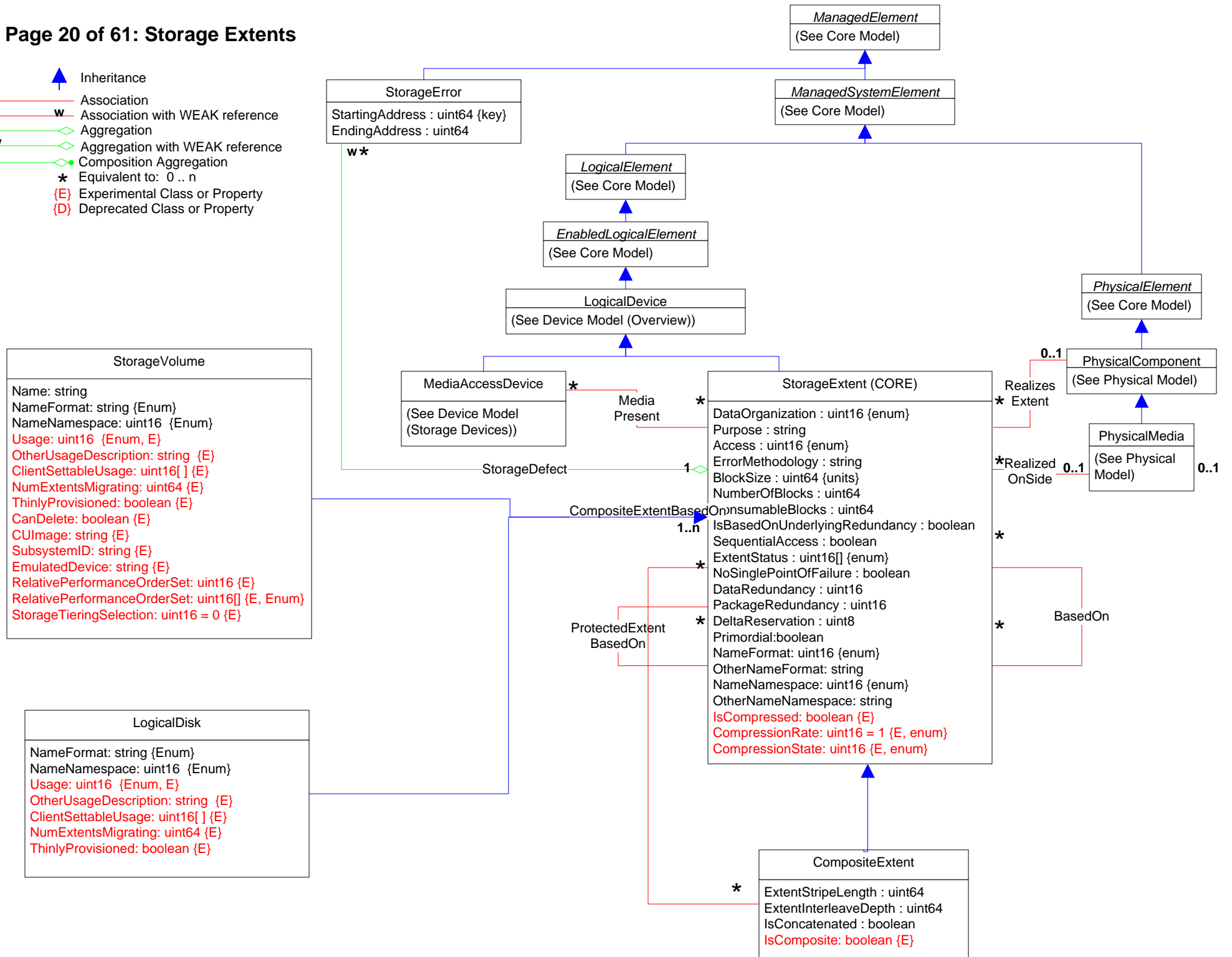

Capabilities
(See core model)

DiskPartitionConfigurationCapabilities {E}

PartitionStyle : uint16 {enum}
 ValidSubPartitionStyles : uint16 [] {enum}
 OtherValidSubPartitionStyles : string []
 Version : uint16
 MaxNumberOfPartitions : uint16
 SupportedSynchronousActions: uint16[] {enum}
 MaxCapacity : uint64
 OverlapAllowed : boolean
 PartitionTableSize : uint32

StorageElementCompositionCapabilities {E}

MaxCompositeElements: uint64
 MaxCompositeSize: uint64
 SupportsCompositeNaming: boolean
 SupportsComposites: boolean
 SupportsRepresentativeElement: boolean
 CompositeSourcesSupported: uint16[] {enum}
 CompositeCharacteristics: uint16[] {enum}
 CompositeMethodsSupported: uint16[] {enum}
 SupportedAsynchronousActions: uint16[] {enum}
 SupportedStorageElements: uint16[] {enum}
 SupportedSynchronousActions: uint16[] {enum}

0..1

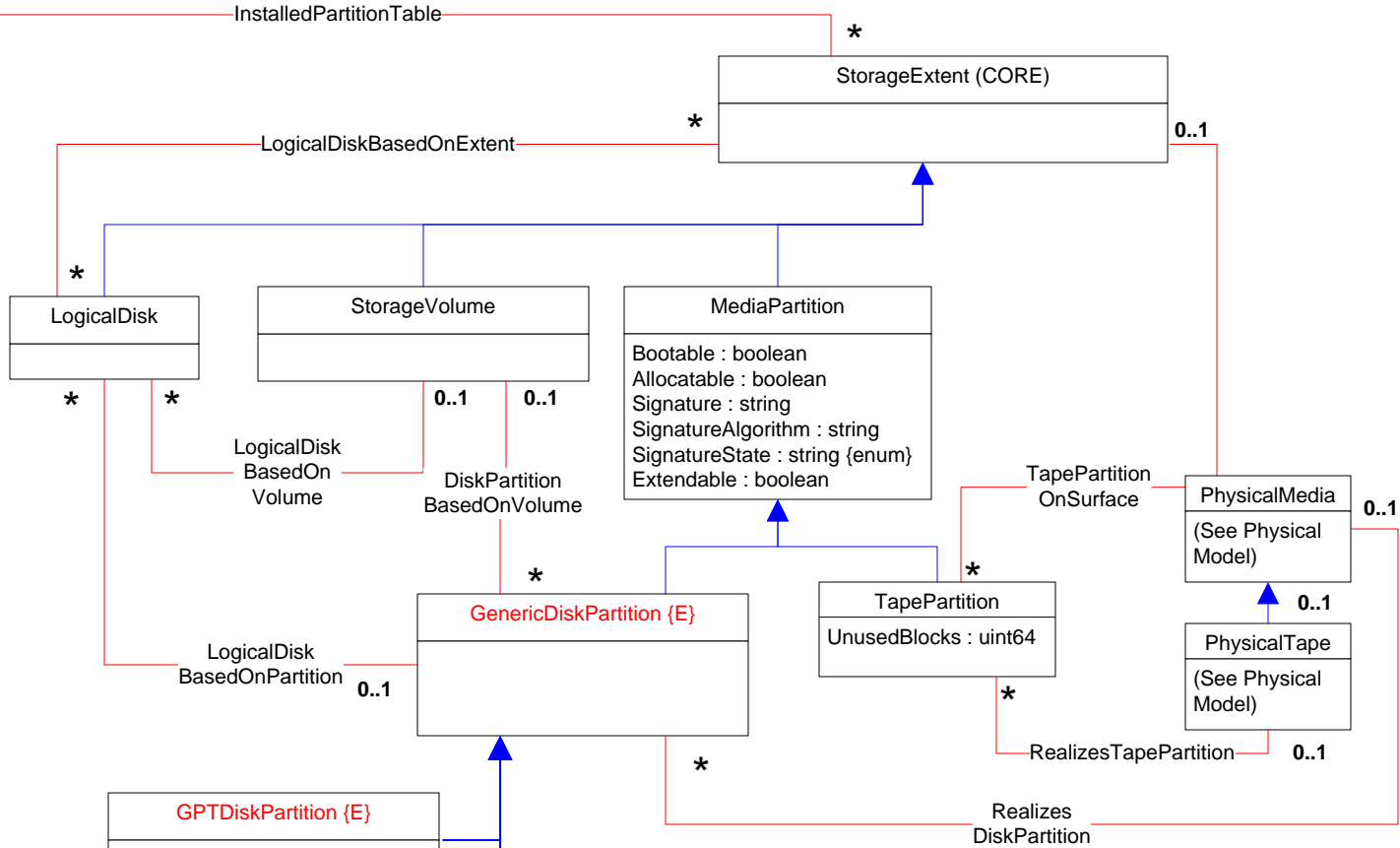

GPTDiskPartition {E}

PartitionType: string

EFIDiskPartition {E}

VTOCDiskPartition {E}

Flags : uint16 {enum}
 Tag : uint16 {enum}
 AsciiLabel : string

DiskPartition

NameFormat: uint16 {enum}
 NameNamespace: uint16 {enum}
 PartitionSubtype: uint16 {enum}
 PartitionType: uint16 {enum}
 PrimaryPartition: boolean

DiskPartitionConfigurationCapabilities {E}

PartitionStyle : uint16 {enum}
 ValidSubPartitionStyles : uint16 [] {enum}
 OtherValidSubPartitionStyles : string []
 Version : uint16
 MaxNumberOfPartitions : uint16
 SupportedSynchronousActions: uint16[] {enum}
 MaxCapacity : uint64
 OverlapAllowed : boolean
 PartitionTableSize : uint32

- Inheritance
- Association
- Association with WEAK reference
- Aggregation
- Aggregation with WEAK reference
- Composition Aggregation
- Equivalent to: 0..n
- Experimental Class or Property
- Deprecated Class or Property

Service
(See Core model)

StorageElementCompositionService









DiskPartitionConfigurationService {E}

PartitioningSchemes : uint16 {enum}

SetPartitionStyle (
 [IN] Extent : ref StorageExtent
 [IN] PartitionStyle : ref DiskPartitionConfigurationCapabilities
) : uint32 {enum}

CreateOrModifyPartition (
 [IN] Extent : ref StorageExtent
 [IN] StartingAddress : uint64
 [IN] EndingAddress : uint64
 [IN] DeviceFileName : string
 [IN] Partition: ref GenericDiskPartition
) : uint32 {enum}

Page 22 of 61: StorageNameBinding

-  Inheritance
-  Association
-  Association with WEAK reference
-  Aggregation
-  Aggregation with WEAK reference
-  Composition Aggregation
-  Equivalent to: 0..n
-  Experimental Class or Property
-  Deprecated Class or Property

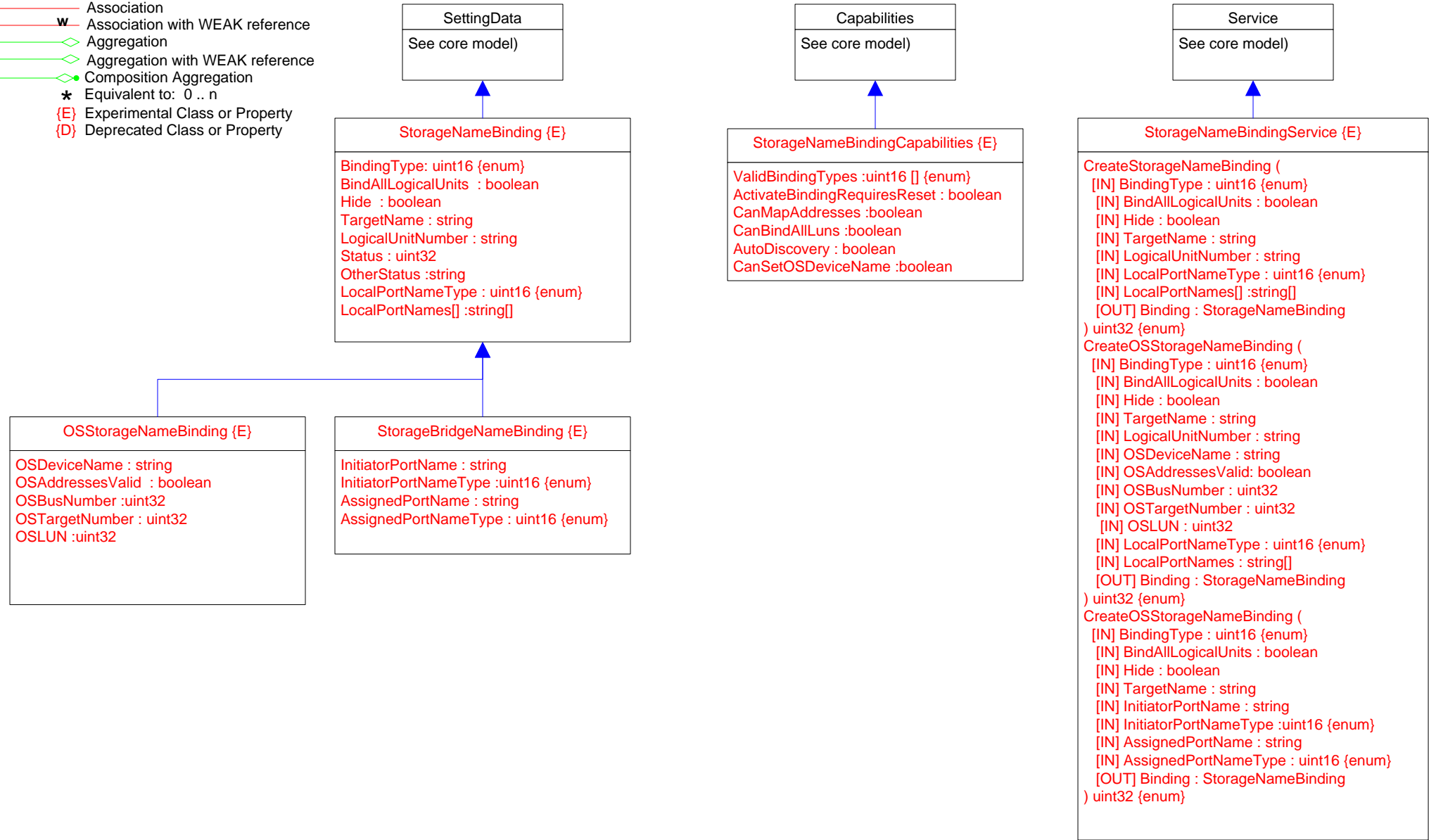

Page 23 of 61: SCC Extents

▲ Inheritance

- Association
- w Association with WEAK reference
- ◊ Aggregation
- ◊w Aggregation with WEAK reference
- ◊• Composition Aggregation
- ★ Equivalent to: 0..n
- {E} Experimental Class or Property
- {D} Deprecated Class or Property

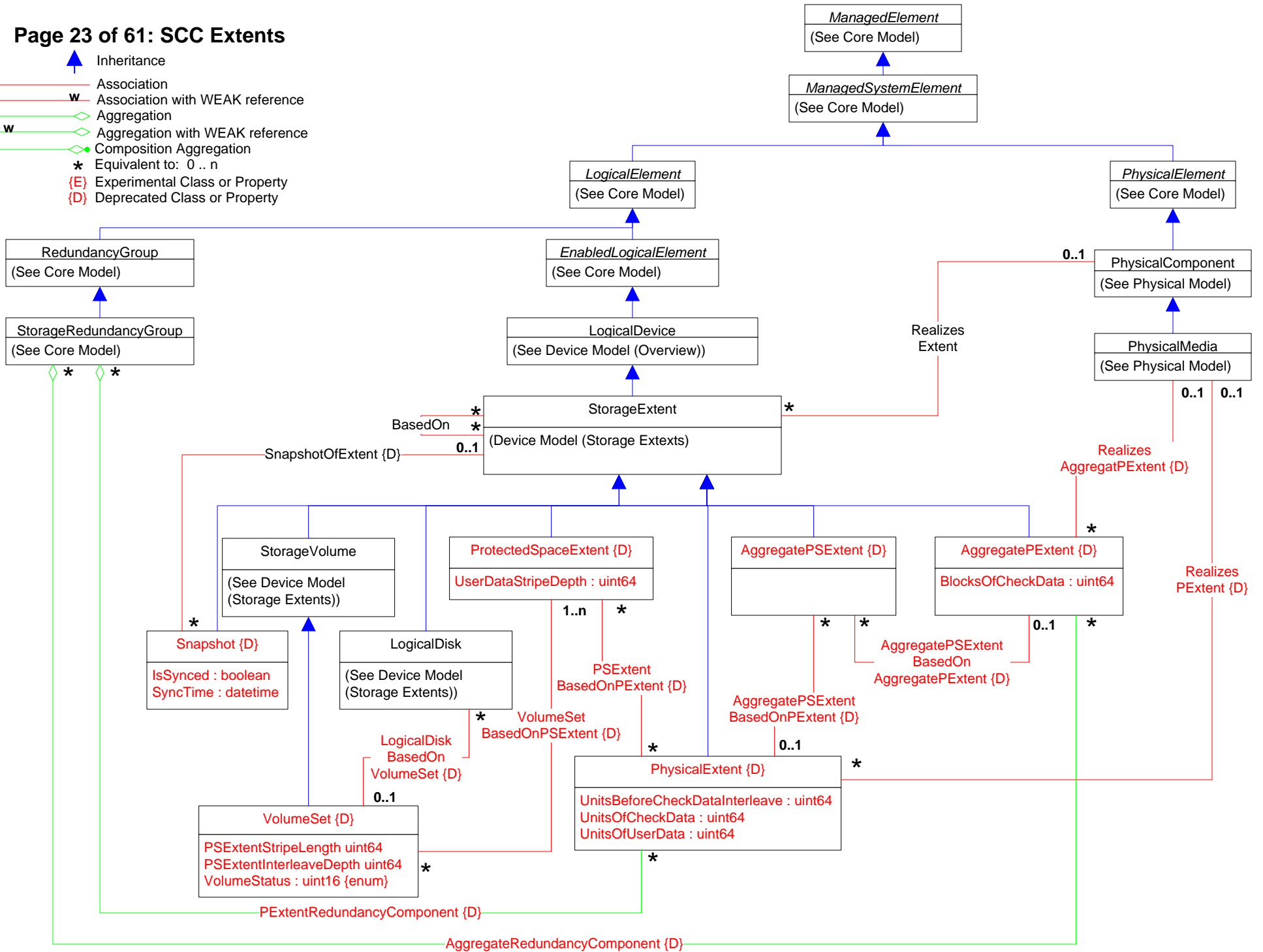

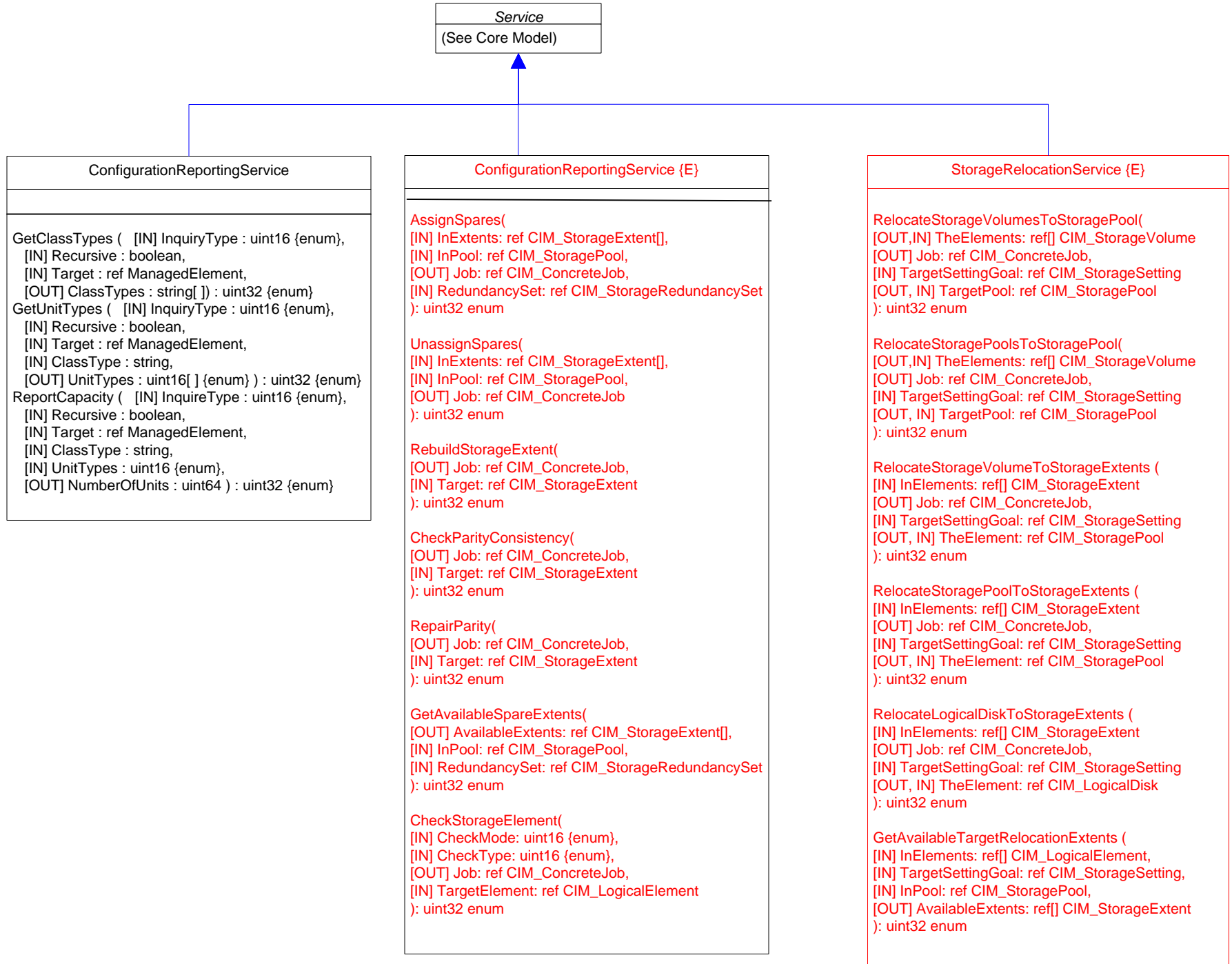

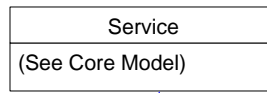

StorageConfigurationService {E}

```

CreateOrModifyStoragePool(
  [IN] string ElementName, [OUT] CIM_ConcreteJob ref Job, [IN] CIM_StorageSetting ref Goal, [IN] uint64 Size, [IN] string InPools[], [IN] string InExtents[], [OUT, IN] Pool: ref CIM_StoragePool ); uint32 (enum)
CreateOrModifyElementFromStoragePool(
  [IN] string ElementName, [IN] uint16 ElementType, [IN] Job: ref CIM_ConcreteJob, [IN] Goal: ref CIM_ManagedElement, [IN] uint64 Size, [IN] InPool: ref CIM_StoragePool, [OUT, IN] TheElement: ref
CIM_LogicalElement ); uint32 (enum)
DeleteStoragePool(
  [IN] Job: ref CIM_ConcreteJob, [IN] Pool: ref CIM_StoragePool ); uint32 (enum)
ReturnToStoragePool(
  [IN] Job: ref CIM_ConcreteJob, [IN] TheElement: ref CIM_LogicalElement ); uint32 (enum)
CreateReplica(
  [IN] string ElementName, [IN] Job: ref CIM_ConcreteJob, [IN] SourceElement: ref CIM_LogicalElement, [IN] TargetElement: ref CIM_LogicalElement, [IN] TargetSettingGoal" ref CIM_StorageSetting,
  [IN] TargetPool: ref CIM_StoragePool, [IN] uint16 CopyType (enum)); uint32 (enum)
ModifySynchronization(
  [IN] uint16 Operation, {enum}, [IN] Job: ref CIM_ConcreteJob, [IN] Synchronization: ref CIM_StorageSynchronized ); uint32 (enum)
AttachReplica(
  [IN] Job: ref CIM_ConcreteJob, [IN] SourceElement: ref CIM_ManagedElement, [IN] TargetElement: ref CIM_ManagedElement, [IN] uint16 CopyType {enum}); uint32 (enum)
AttachOrModifyReplica(
  [IN] Job: ref CIM_ConcreteJob, [IN] SourceElement: ref CIM_ManagedElement, [IN] TargetElement: ref CIM_ManagedElement, [IN] uint16 CopyType, {enum} [IN] string Goal, [IN] ReplicationPipe: ref
CIM_NetworkPipe ); uint32 (enum)
CreateOrModifyReplicationPipe(
  [IN] string PipeElementName, [IN] SourceSystem: ref CIM_ComputerSystem, [IN] TargetSystem: ref CIM_ComputerSystem, [IN] SourceEndpoint: ref CIM_ProtocolEndpoint[],
  [[IN] TargetEndpoint: ref CIM_ProtocolEndpoint[], [IN] string Goal, [OUT, IN] ReplicationPipe: ref CIM_NetworkPipe ); uint32 (enum)
CreateReplicationBuffer(
  [IN] Job: ref CIM_ConcreteJob, [IN] Host: ref CIM_ManagedElement, [IN] TargetElement: ref CIM_StorageExtent, [IN] TargetPool: ref CIM_StoragePool, [IN] ReplicaBuffer: ref CIM_Memory ); uint32 (enum)
CreateOrModifyElementFromElements(
  [IN] string ElementName, [IN] uint16 ElementType, {enum}, [IN] Job: ref CIM_ConcreteJob, [IN] Goal: ref CIM_ManagedElement, [IN] uint64 Size, [IN] InElements: ref CIM_StorageExtent[],
  [OUT, IN] TheElement: ref CIM_LogicalElement ); uint32 (enum)
ScsiScan(
  [OUT, IN] CIM_ConcreteJob ref Job, [IN] uint16 ConnectionType, {enum}, [IN] string OtherConnectionType, [IN] Initiators: ref CIM_SCSIProtocolEndpoint[], [IN] string Targets[], [IN] string LogicalUnits[]
); uint32 (enum)
RequestUsageChange(
  [IN] uint16 Operation, {enum}, [IN] uint16 UsageValue, [IN] string OtherUsageDescription, [IN] Job: ref CIM_ConcreteJob, [IN] TheElement: ref CIM_LogicalElement ); uint32 (enum)
GetElementsBasedOnUsage(
  [IN] uint16 ElementType, {enum}, [IN] uint16 Usage, [IN] uint16 Criteria, {enum}, [IN] ThePool: ref CIM_StoragePool, [IN] TheElements: ref CIM_ManagedSystemElement[]); uint32 (enum)
AssignStorageResourceAffinity(
  [IN] uint16 ResourceType, [IN] Job: ref CIM_ConcreteJob, [IN] StorageProcessor: ref CIM_ComputerSystem, [IN] StorageResources: ref CIM_LogicalElement[]); uint32 (enum)
CreateElementsFromStoragePool(
  [IN] string ElementNames[], [IN] uint16 ElementType, {enum}, [IN] uint64 ElementCount, [IN] Job: ref CIM_ConcreteJob, [IN] Goal: ref CIM_ManagedElement, [IN] uint64 Size, [IN] InPool: ref
CIM_StoragePool, [IN] TheElements: ref CIM_LogicalElement[]); uint32 (enum)
ReturnElementsToStoragePool(
  [IN] uint16 Options, {enum}, [IN] Job: ref CIM_ConcreteJob, [IN] TheElements: ref CIM_LogicalElement[]); uint32 (enum)

```

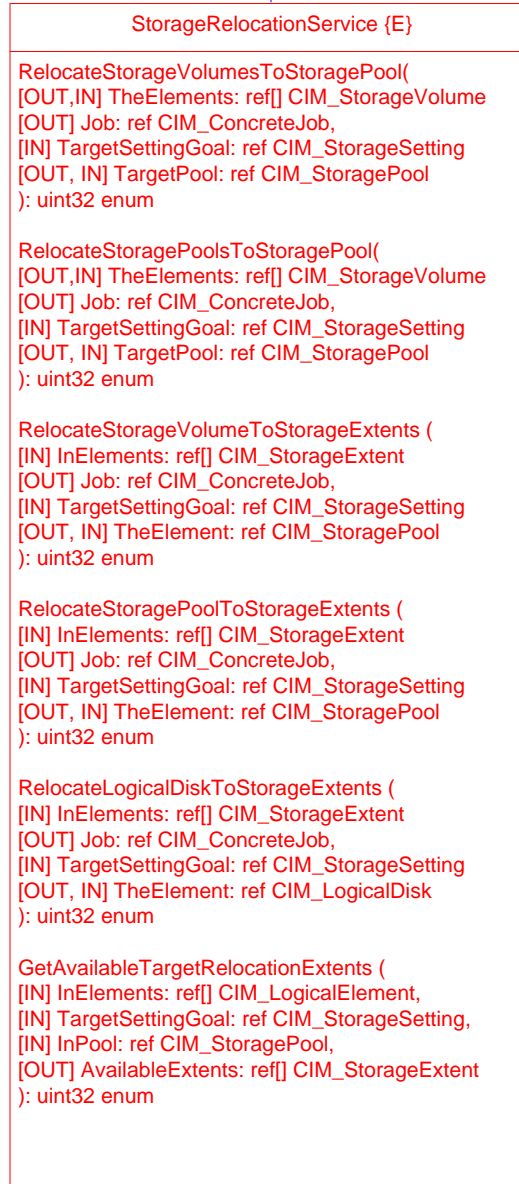
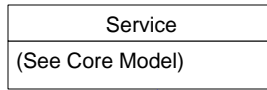

Page 27 of 61: Storage liers 1

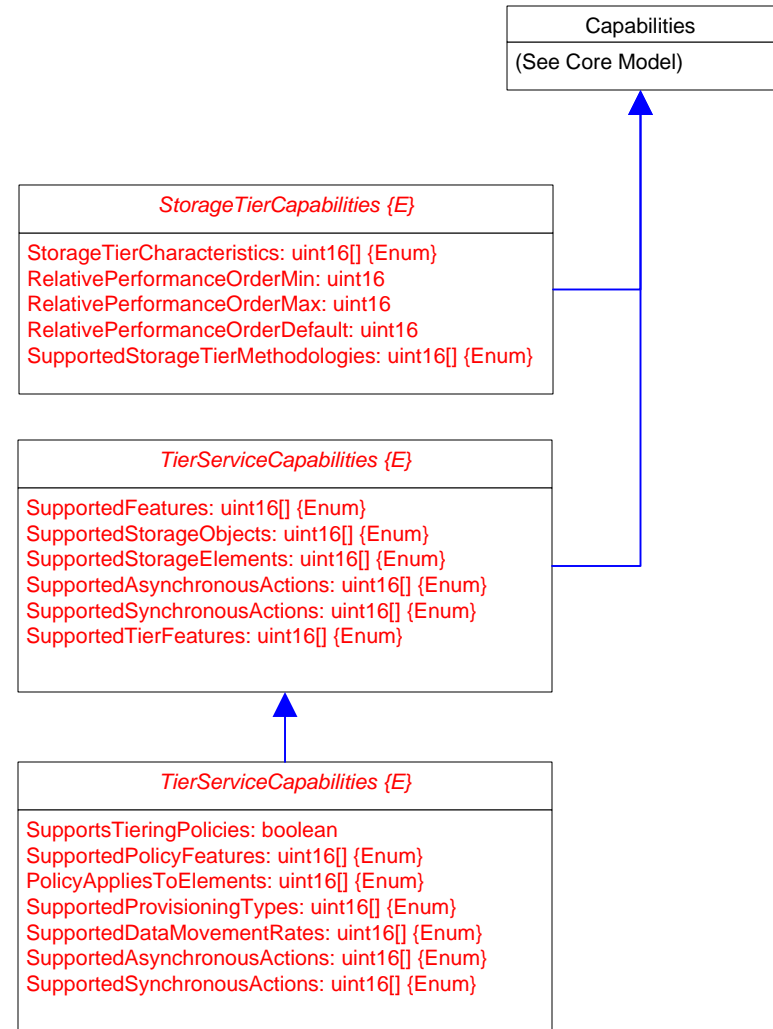
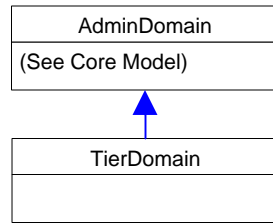
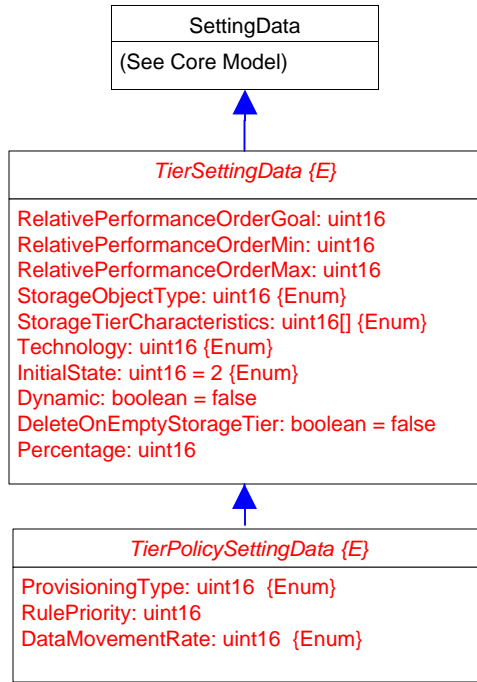

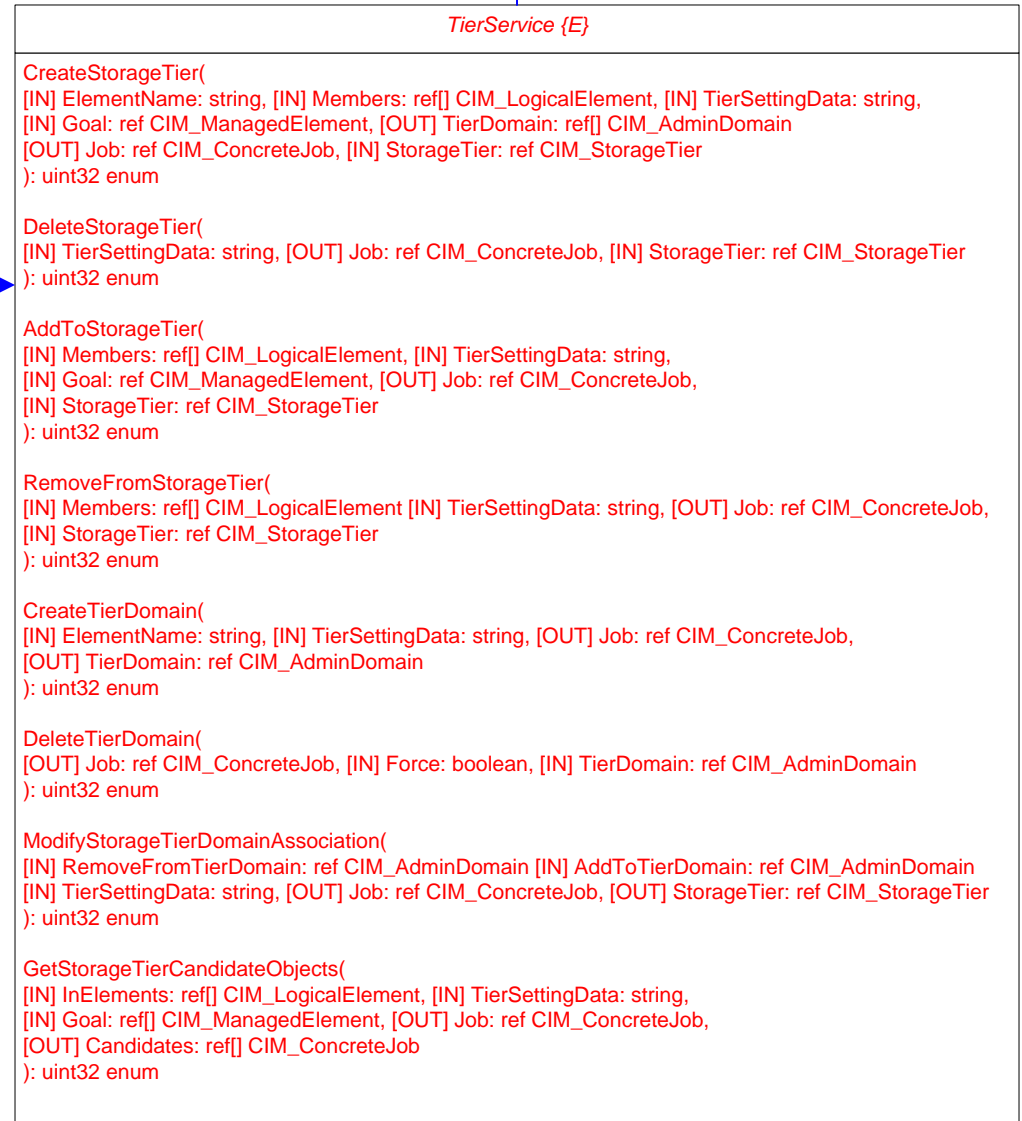
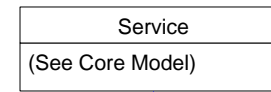

Page 29 of 61: Storage Groups

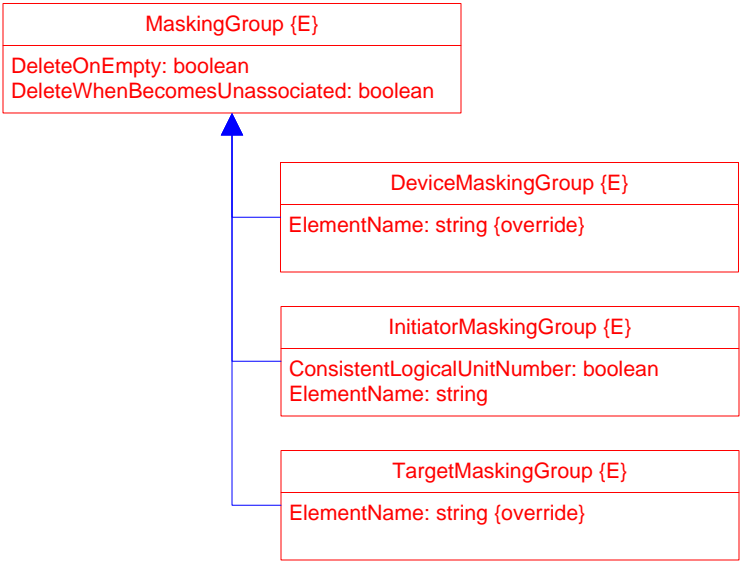
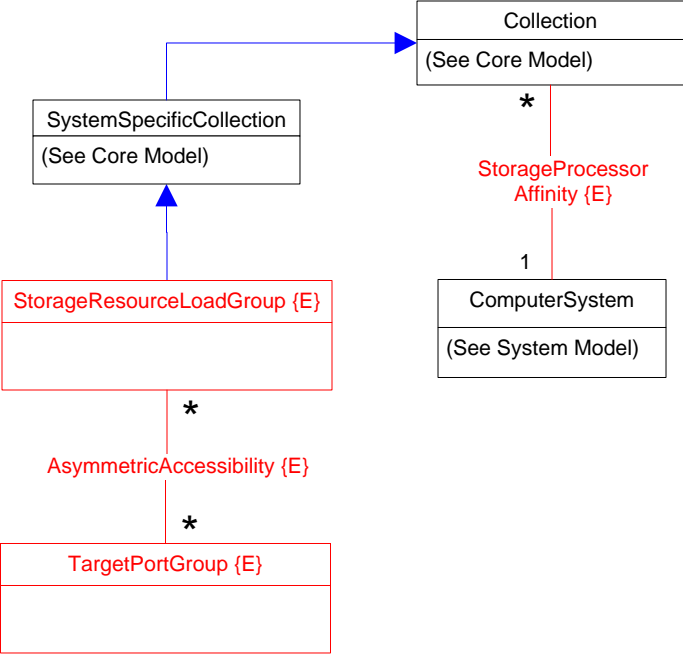

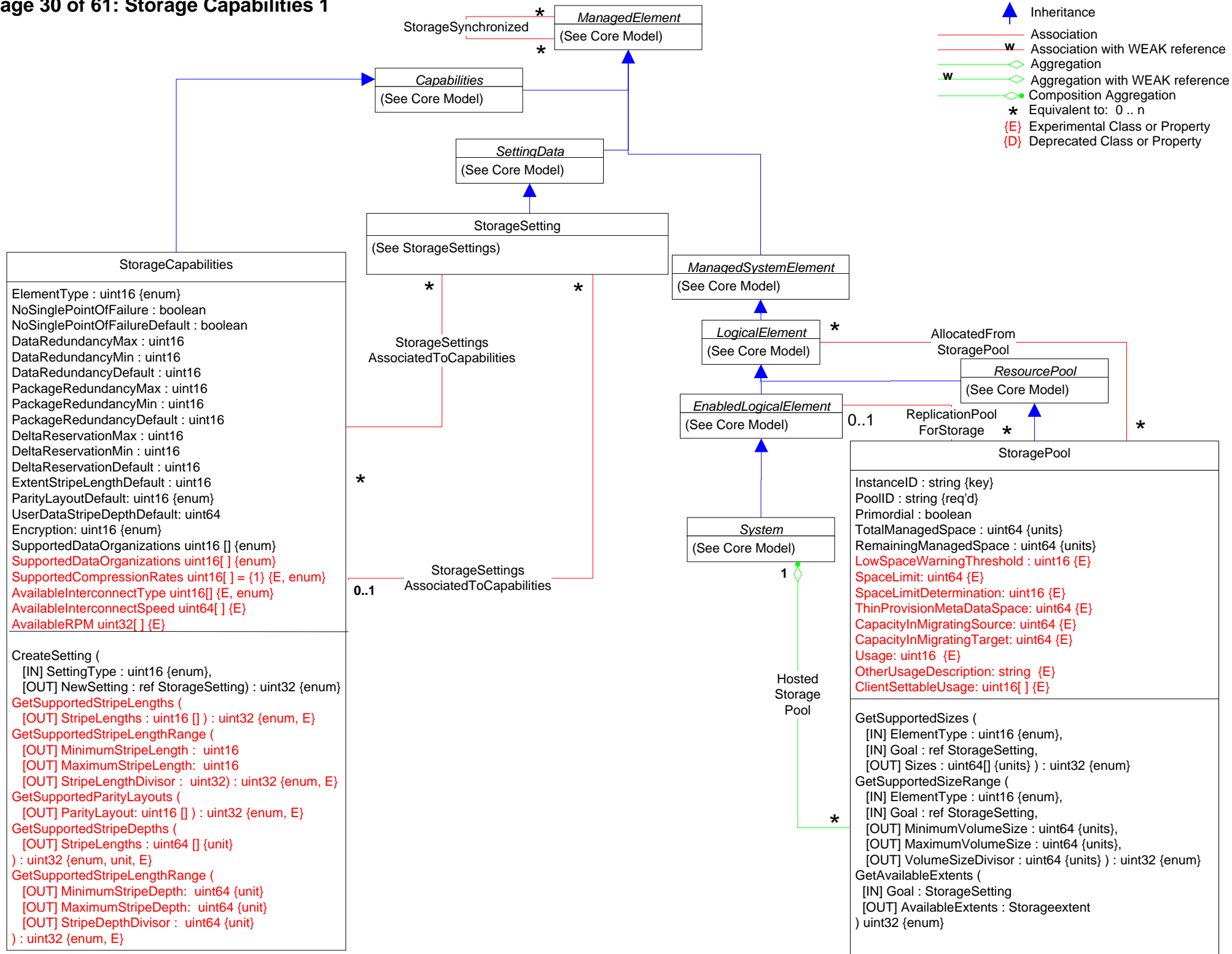

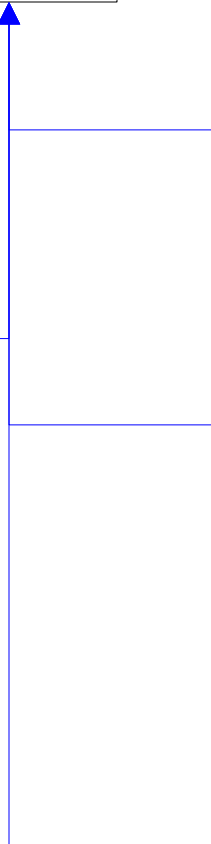
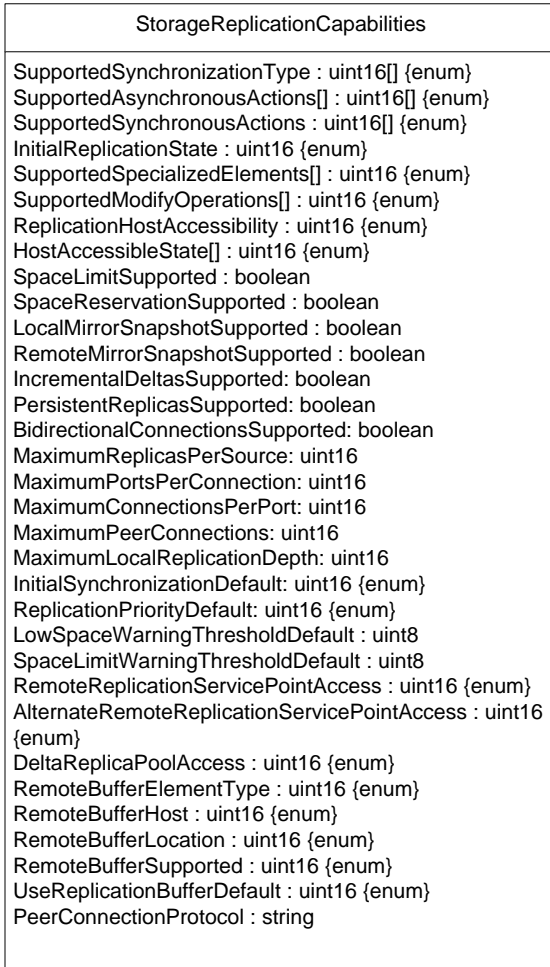
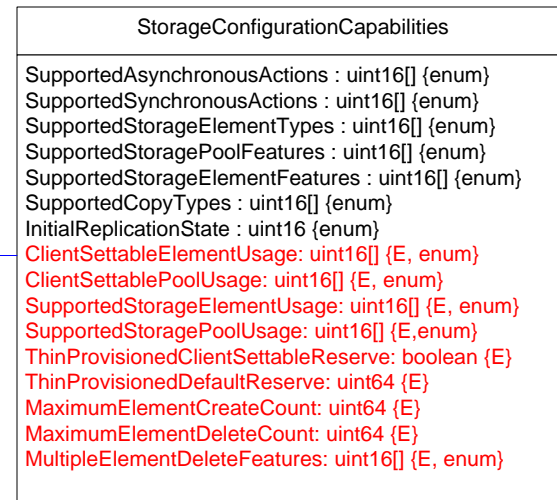
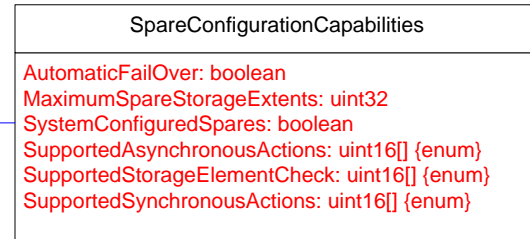
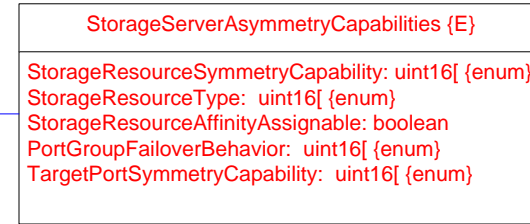
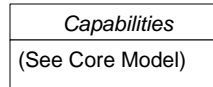

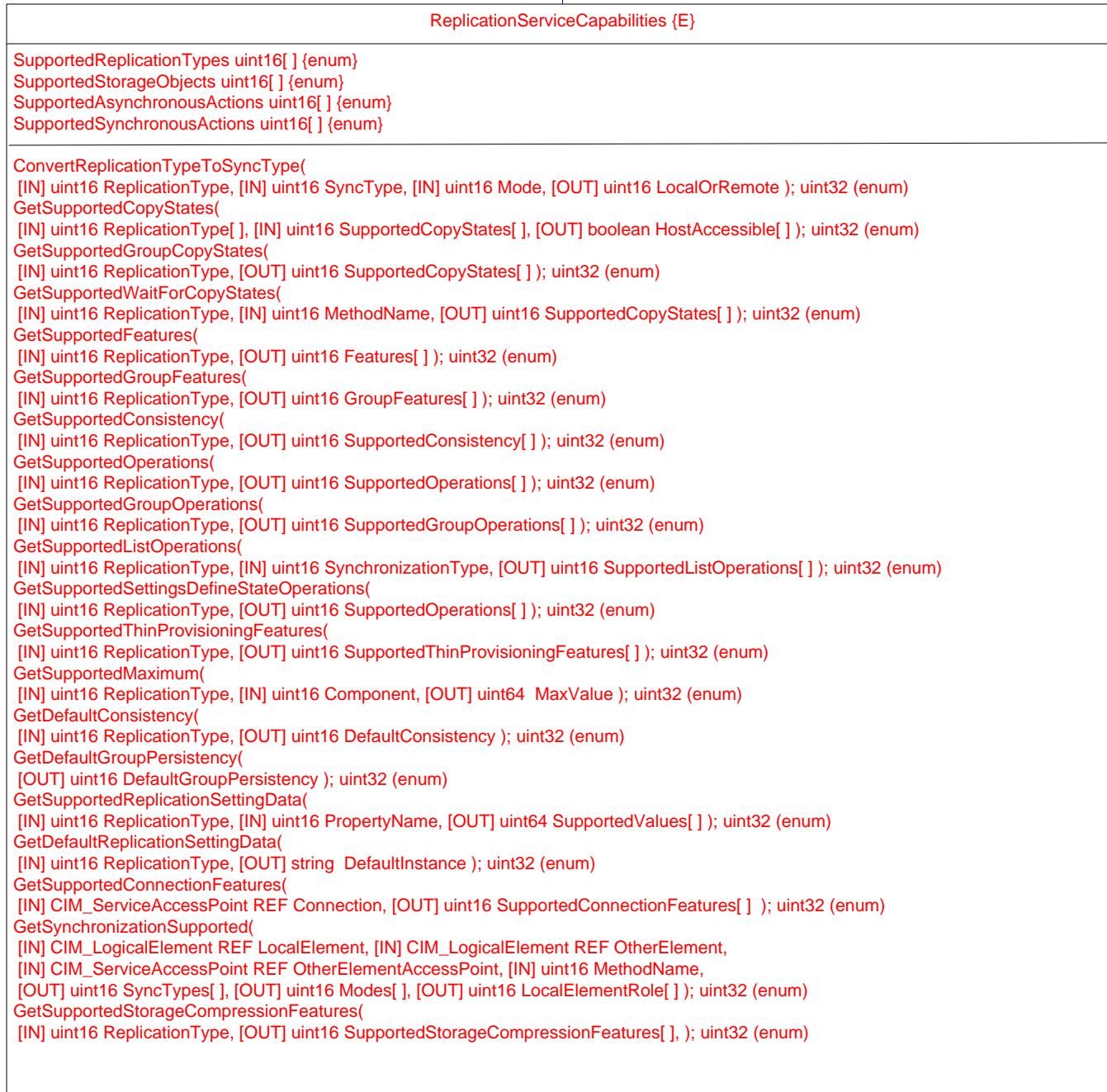
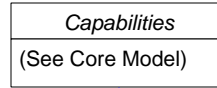

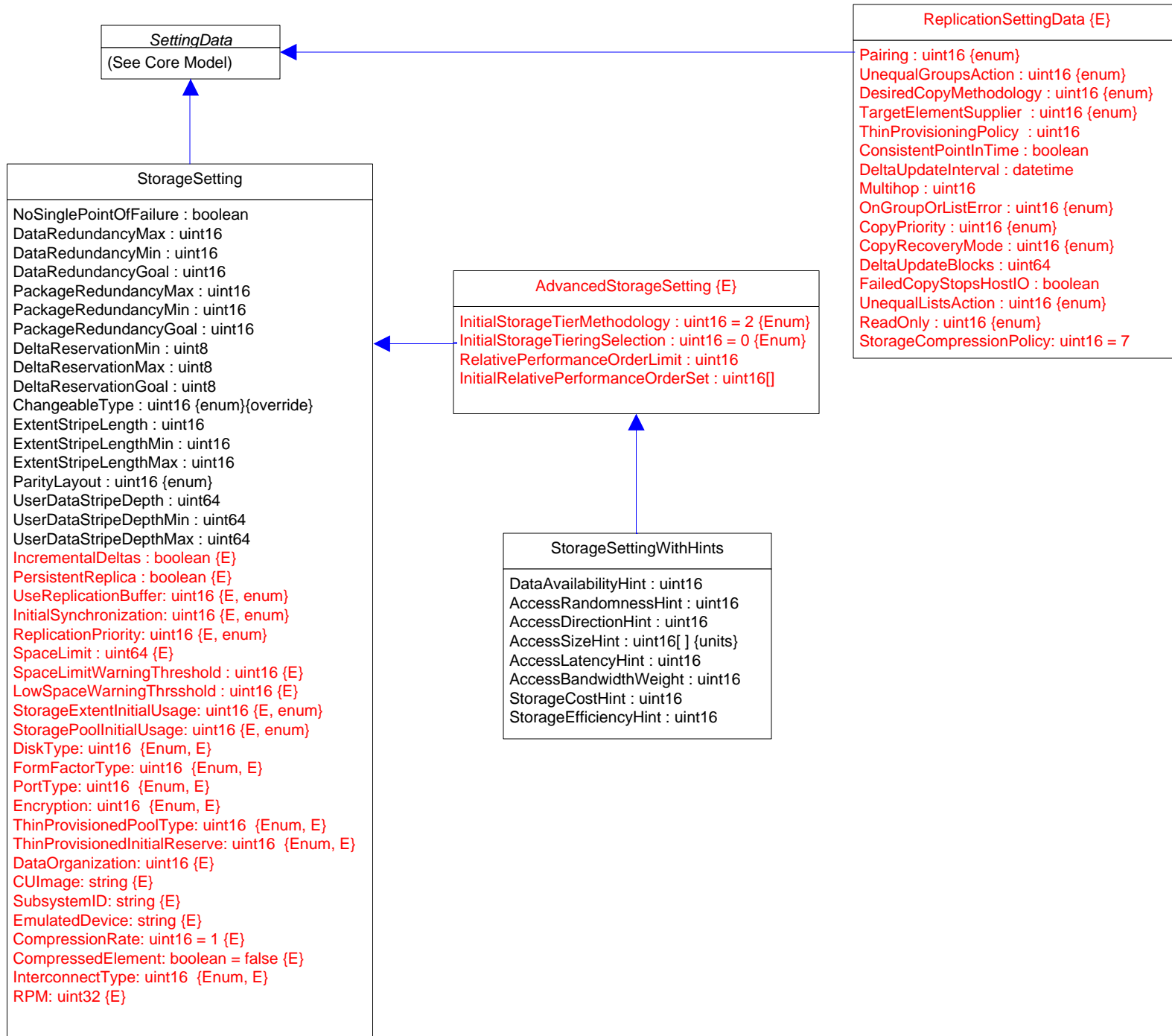

Page 34 of 61: Storage Statistics

-  Inheritance
- Association
- Association with WEAK reference
- Aggregation
- Aggregation with WEAK reference
- Composition Aggregation
- Equivalent to: 0..n
- Experimental Class or Property
- Deprecated Class or Property

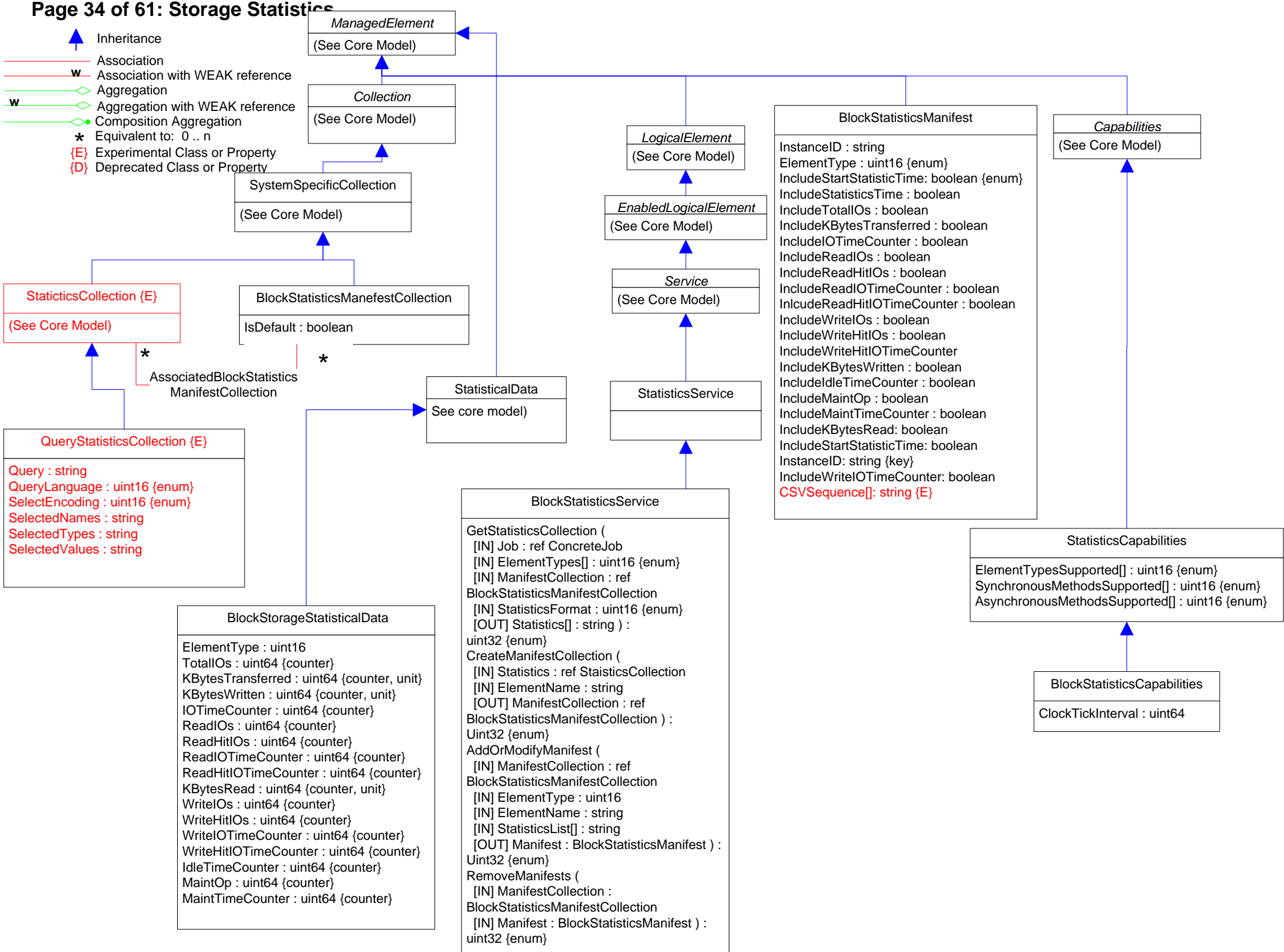

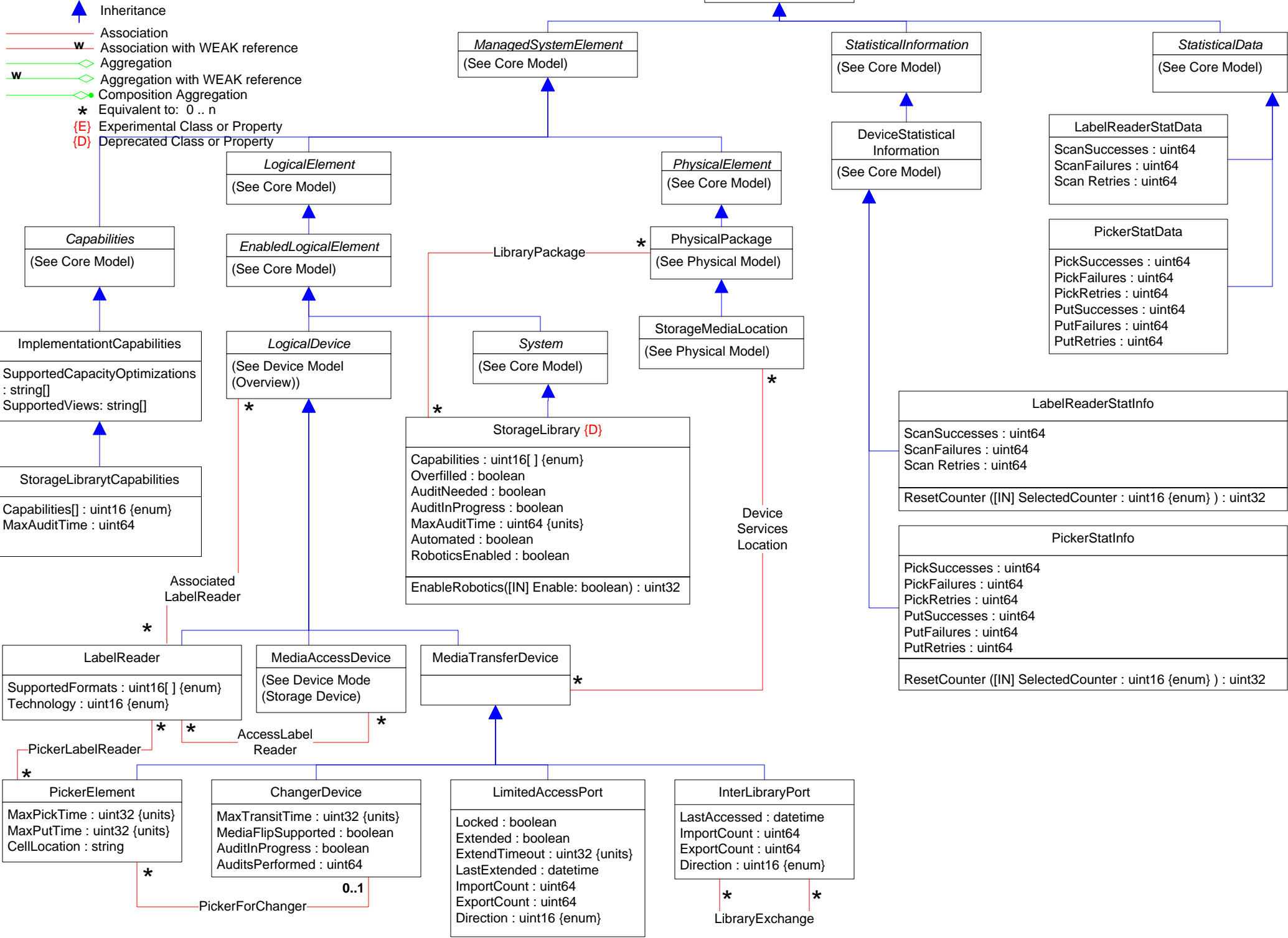

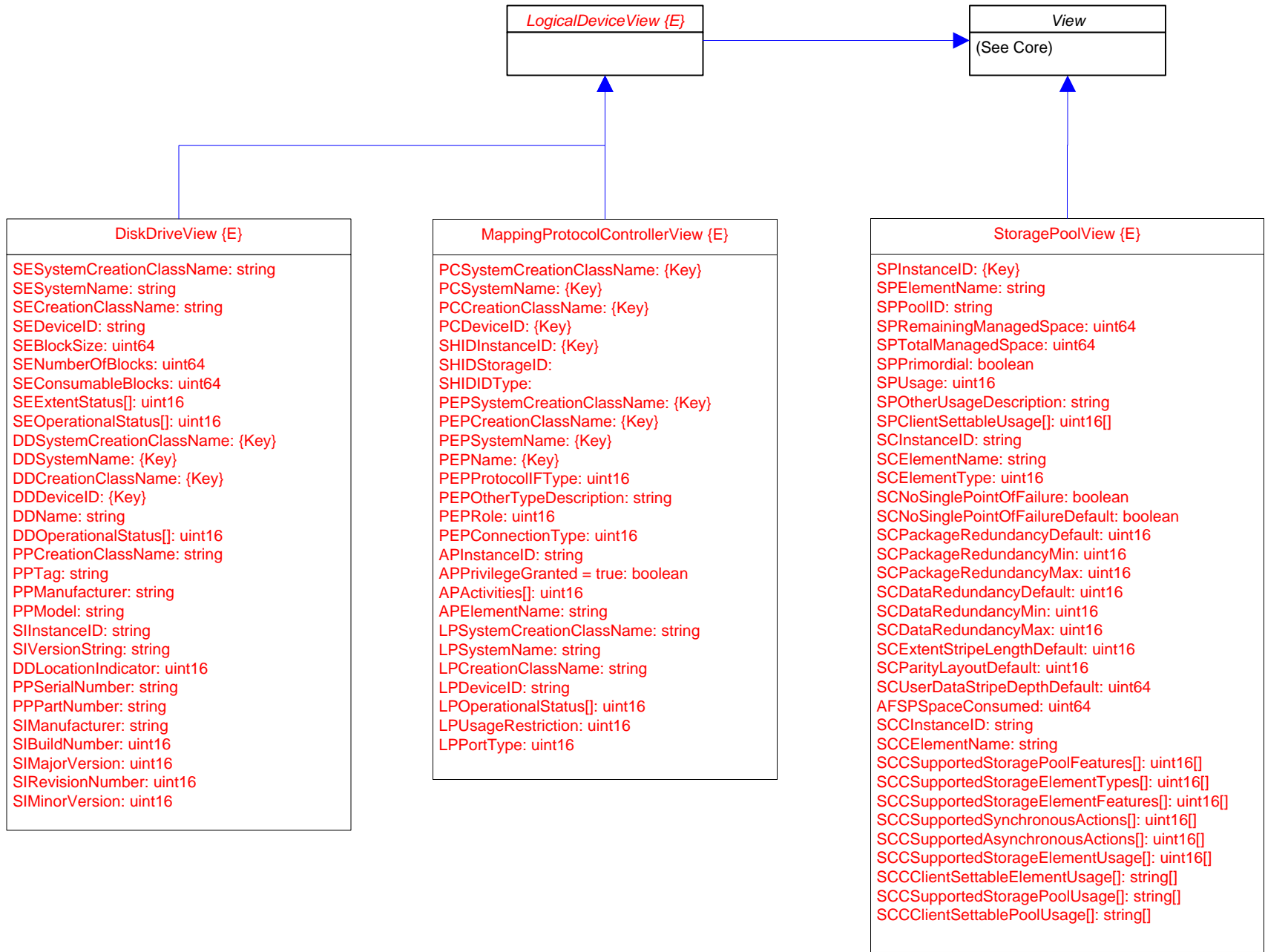

VolumeView {E}
SVSystemCreationClassName: {Key}
SVSystemName: {Key}
SVCreationClassName: {Key}
SVDeviceID: {Key}
SVName: string
SVNameFormat: uint16
SVNameNamespace: uint16
SVExtentStatus[]: uint16
SVOperationalStatus[]: uint16
SVBlockSize: uint64
SVNumberOfBlocks: uint64
SVConsumableBlocks: uint64
SVIsBasedOnUnderlyingRedundancy: boolean
SVNoSinglePointOfFailure: boolean
SVDataRedundancy: uint16
SVPackageRedundancy: uint8
SVDeltaReservation: uint8
SVUsage: uint16
SVOtherUsageDescription: string
SVClientSettableUsage[]: uint16
SSInstanceID: string
SSElementName: string
SSNoSinglePointOfFailure: boolean
SSDataRedundancyMin: uint16
SSDataRedundancyMax: uint16
SSDataRedundancyGoal: uint16
SSPackageRedundancyMin: uint16
SSPackageRedundancyMax: uint16
SSPackageRedundancyGoal: uint16
SSChangeableType: uint16
AFSPSpaceConsumed: uint64
SPInstanceID: {Key}
SPPoolID: string
SVOtherIdentifyingInfo[]: string
SVIdentifyingDescriptions[]: string
SVElementName: string
SVPrimordial: boolean
SVExtentDiscriminator[]: string
SSExtentStripeLength: uint16
SSExtentStripeLengthMin: uint16
SSExtentStripeLengthMax: uint16
SSParityLayout: uint16
SSUserDataStripeDepth: uint64
SSUserDataStripeDepthMin: uint64
SSUserDataStripeDepthMax: uint64
SSStoragePoolInitialUsage: uint16
SSStorageExtentInitialUsage: uint16
SVIsComposite: boolean

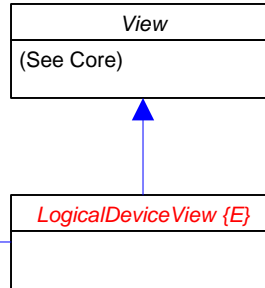





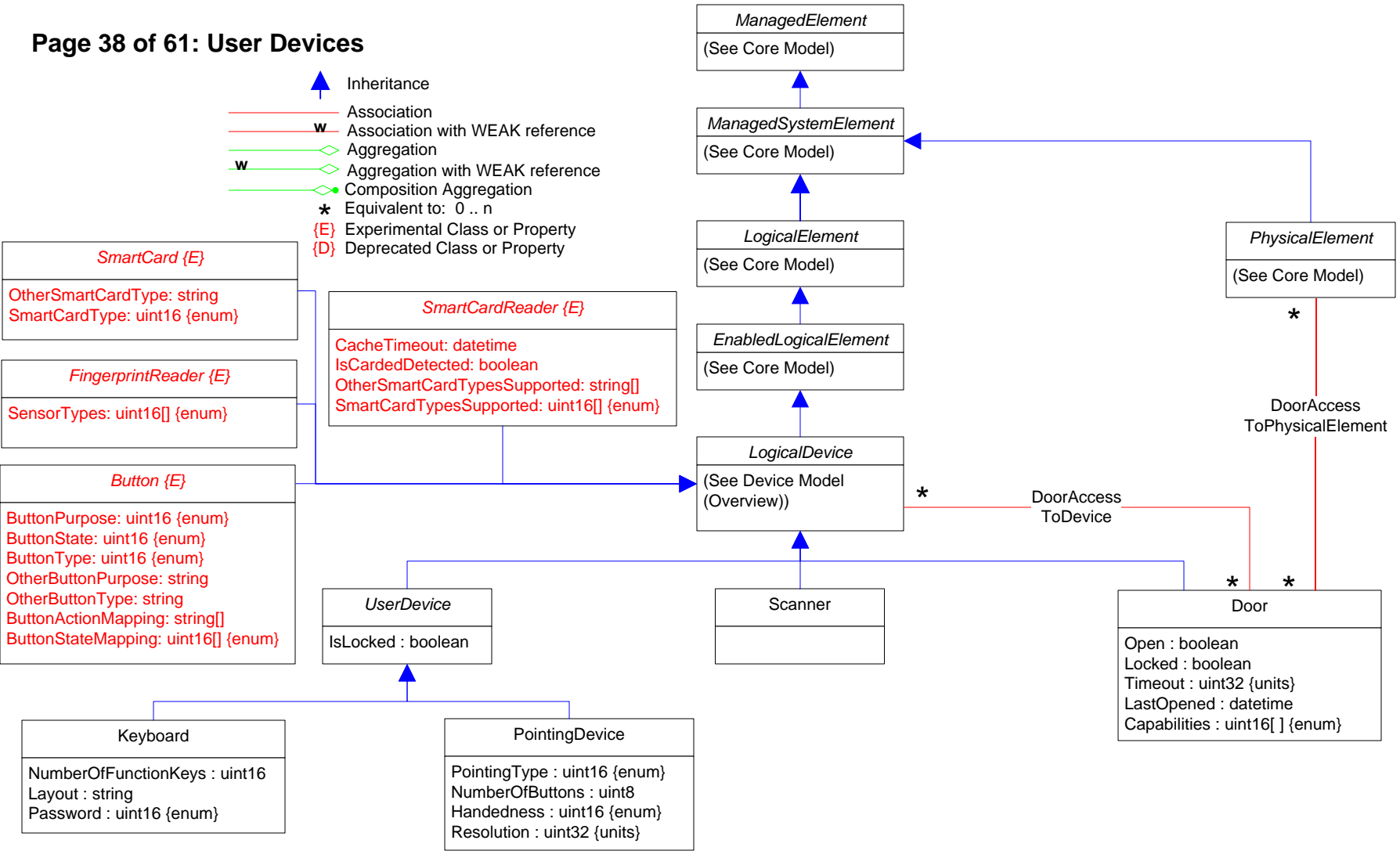

ReplicaPairView {E}
SVSourceSystemCreationClassName: string
SVSourceSystemName: string
SVSourceCreationClassName: string
SVSourceDeviceID: string
SVSourceName: string
SVSourceNameFormat: uint16
SVSourceNameNamespace: uint16
SVSourceExtentStatus: uint16[]
SVSourceOperationalStatus: uint16[]
SVSourceBlockSize: uint64
SVSourceNumberOfBlocks: uint64
SVSourceConsumableBlocks: uint64
SVSourcePrimordial: boolean
SVSourceIsBasedOnUnderlyingRedundancy: boolean
SVSourceNoSinglePointOfFailure: boolean
SVSourceDataRedundancy: uint16
SVSourcePackageRedundancy: uint16
SVSourceDeltaReservation: uint8
SVSourceExtentDiscriminator: string[]
SVSourceOtherIdentifyingInfo: string[]
SVSourceIdentifyingDescriptions: string[]
SVSourceElementName: string
SVSourceUsage: uint16
SVSourceOtherUsageDescription: string
SVSourceClientSettableUsage: uint16[]
SSWhenSynced: datetime
SSSyncMaintained: boolean
SSCopyType: uint16
SSSyncState: uint16
SSCopyPriority: uint16
SSSyncType: uint16
SSMode: uint16
SSProgressStatus:
SVTargetSystemCreationClassName: {Key}
SVTargetSystemName: {Key}
SVTargetCreationClassName: {Key}
SVTargetDeviceID: {Key}
SVTargetName: string
SVTargetNameFormat: uint16
SVTargetNameNamespace: uint16
SVTargetExtentStatus: uint16
SVTargetOperationalStatus: uint16[]
SVTargetBlockSize: uint64
SVTargetNumberOfBlocks: uint64
SVTargetConsumableBlocks: uint64
SVTargetPrimordial: boolean
SVTargetIsBasedOnUnderlyingRedundancy: boolean
SVTargetNoSinglePointOfFailure: boolean
SVTargetDataRedundancy: uint16
SVTargetPackageRedundancy: uint16
SVTargetDeltaReservation: uint8
SVTargetExtentDiscriminator: string
SVTargetOtherIdentifyingInfo: string
SVTargetIdentifyingDescriptions: string[]
SVTargetElementName: string
SVTargetUsage: uint16
SVTargetOtherUsageDescription: string
SVTargetClientSettableUsage: uint16[]

Page 38 of 61: User Devices

- Inheritance
- Association
- Association with WEAK reference
- Aggregation
- Aggregation with WEAK reference
- Composition Aggregation
- Equivalent to: 0 .. n
- Experimental Class or Property
- Deprecated Class or Property







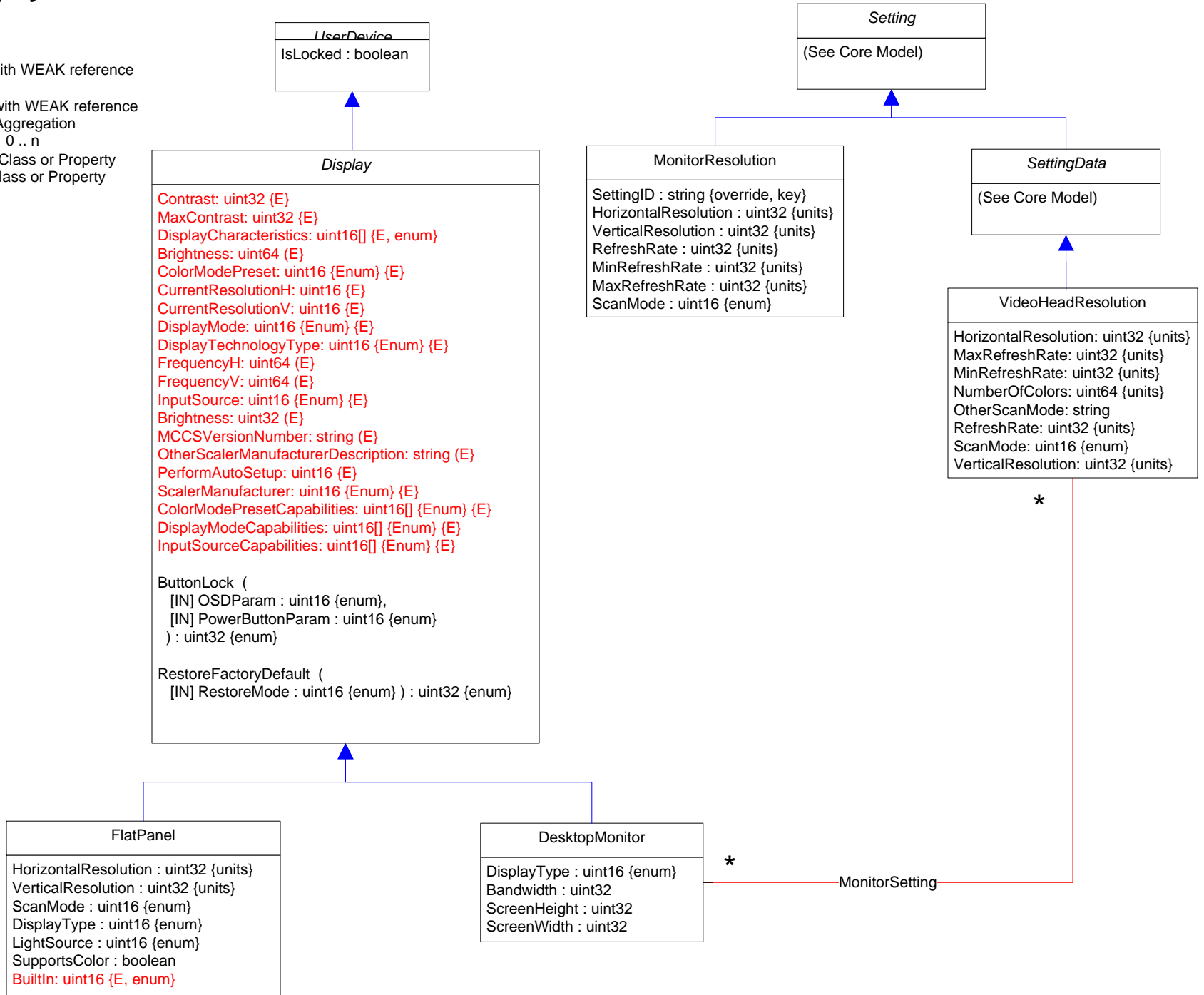



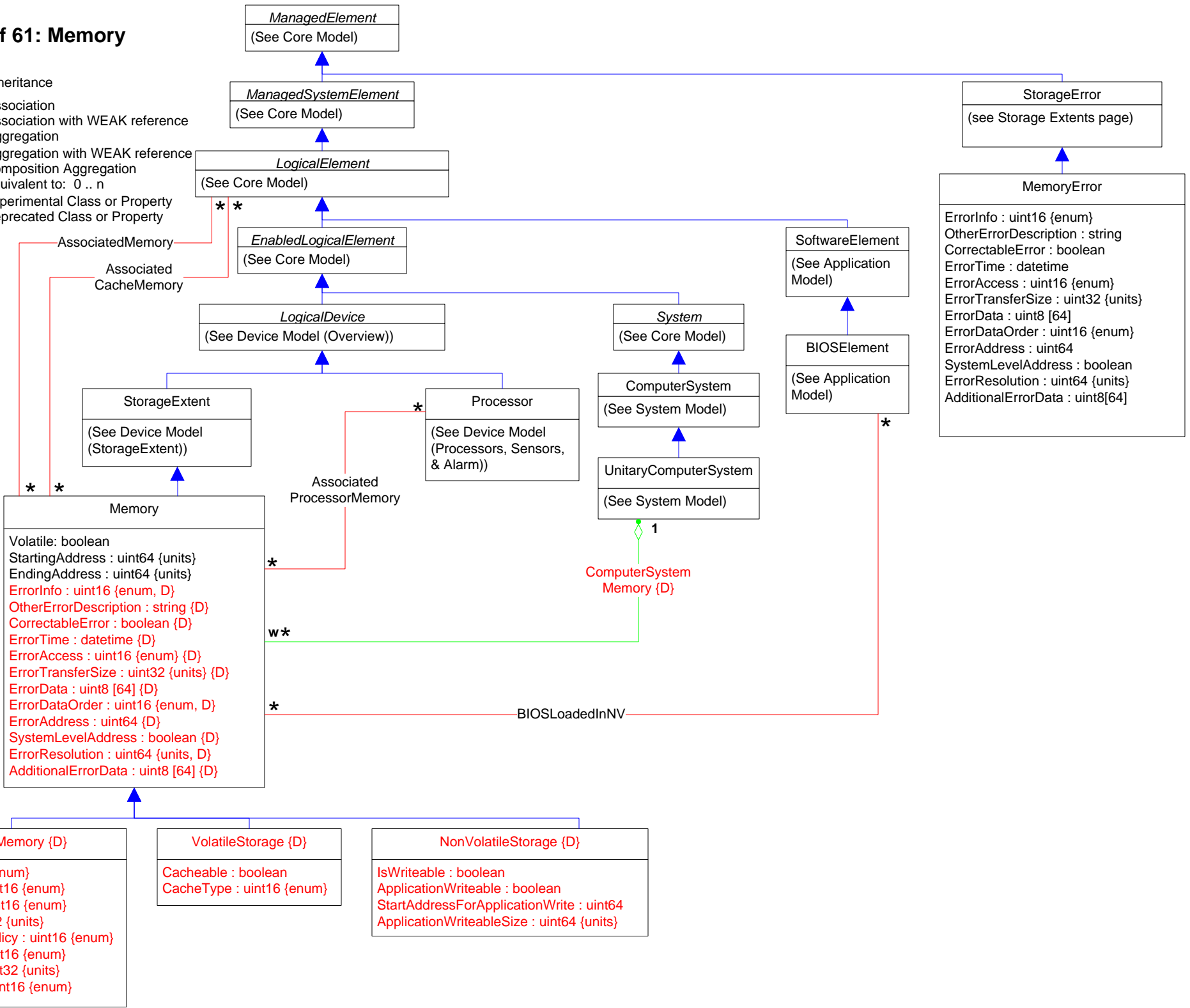

Page 39 of 61: Displays

-  Inheritance
-  Association
-  Association with WEAK reference
-  Aggregation
-  Aggregation with WEAK reference
-  Composition Aggregation
-  Equivalent to: 0..n
- {E} Experimental Class or Property
- {D} Deprecated Class or Property



- Inheritance
- Association
- Association with WEAK reference
- Aggregation
- Aggregation with WEAK reference
- Composition Aggregation
- Equivalent to: 0 .. n
- Experimental Class or Property
- Deprecated Class or Property





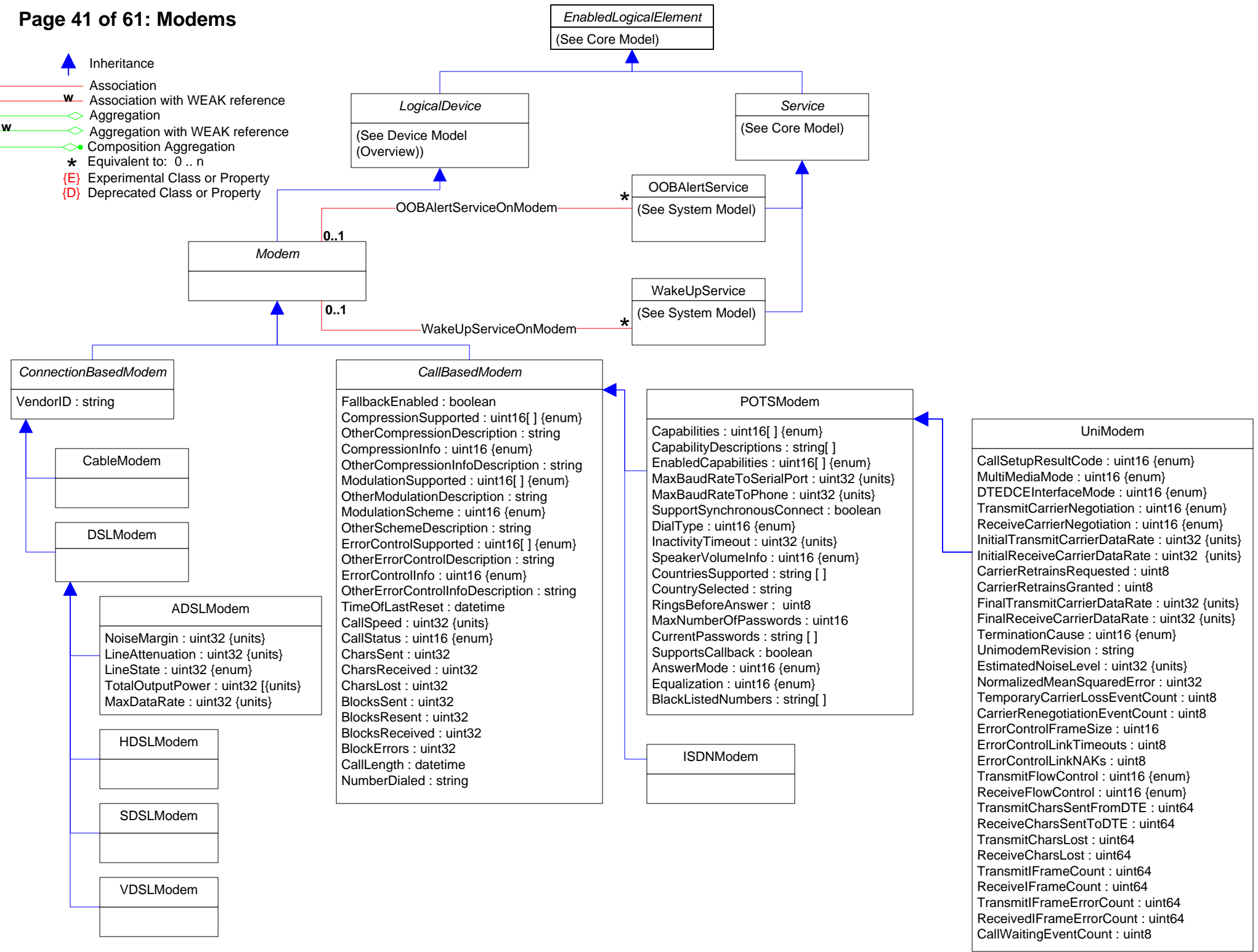

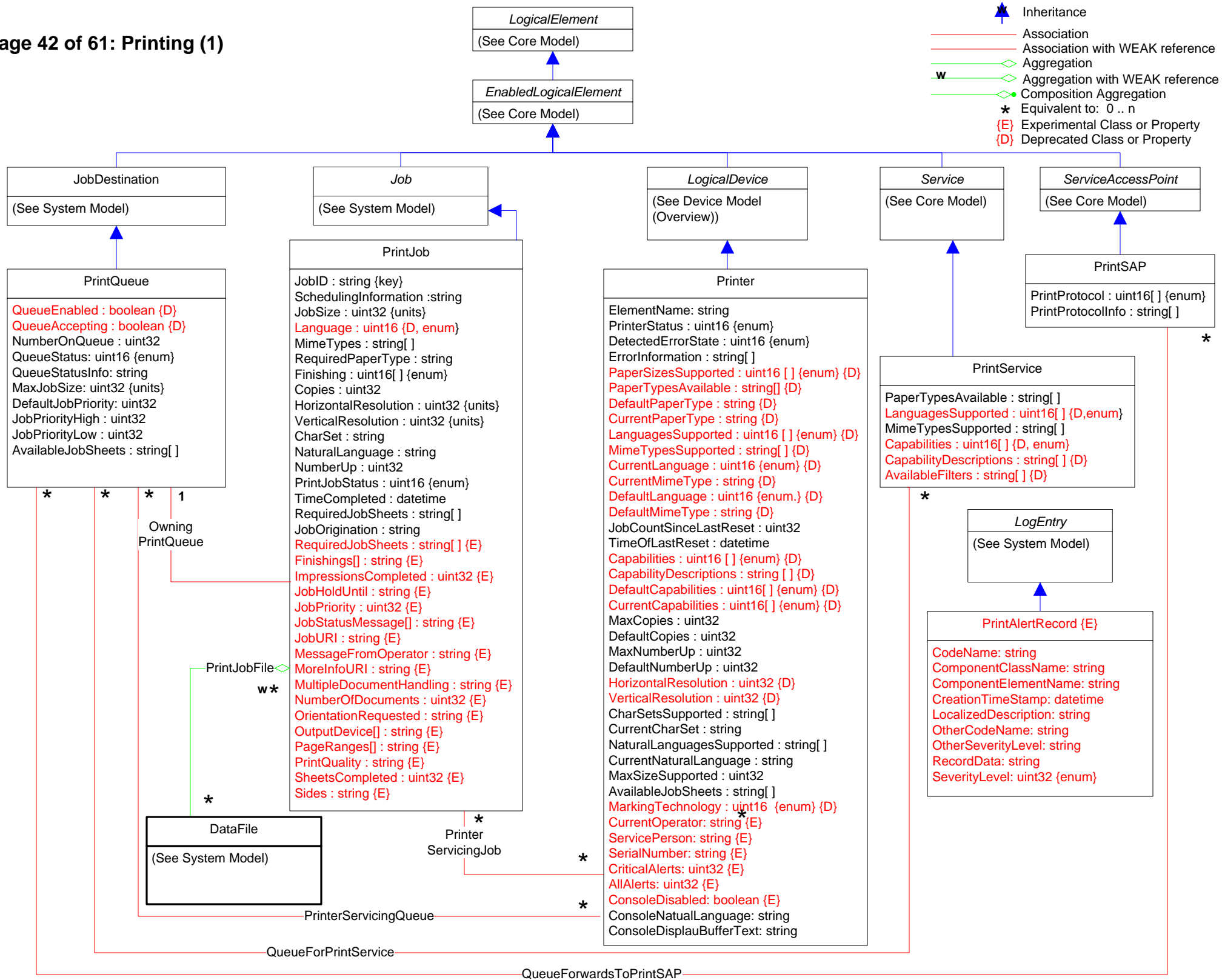

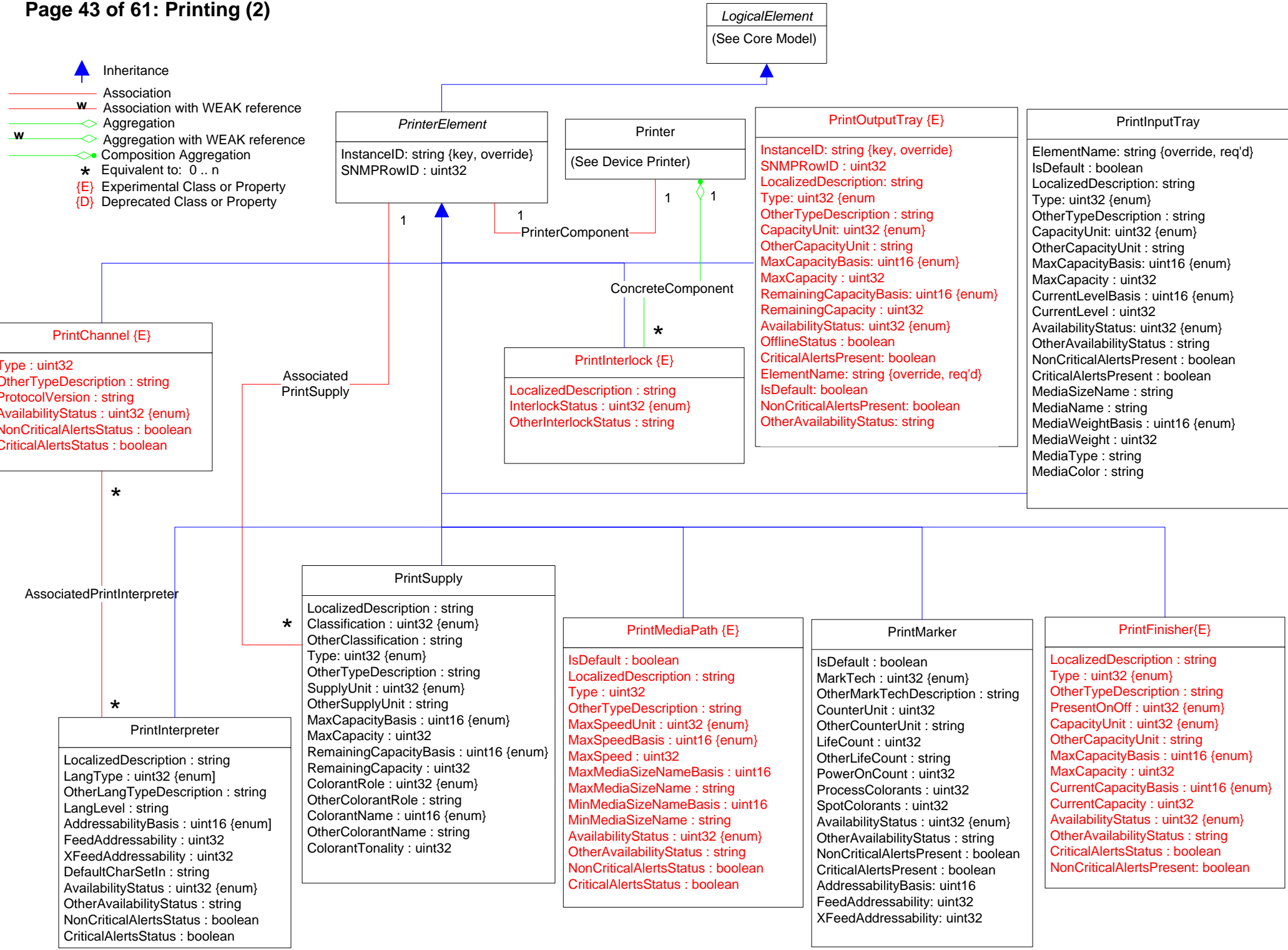

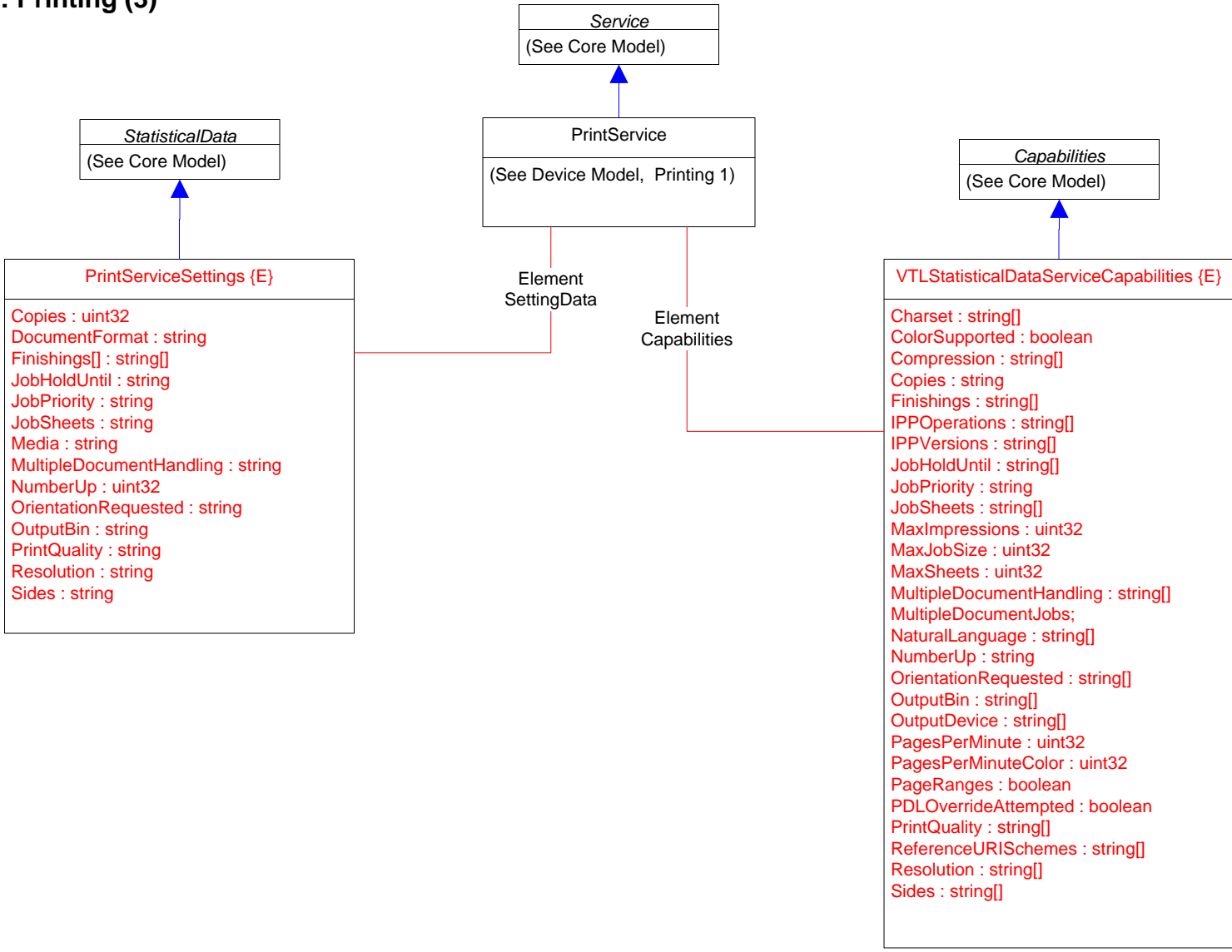

-  Inheritance
-  Association
-  Association with WEAK reference
-  Aggregation
-  Aggregation with WEAK reference
-  Composition Aggregation
-  Equivalent to: 0..n
-  {E} Experimental Class or Property
-  {D} Deprecated Class or Property











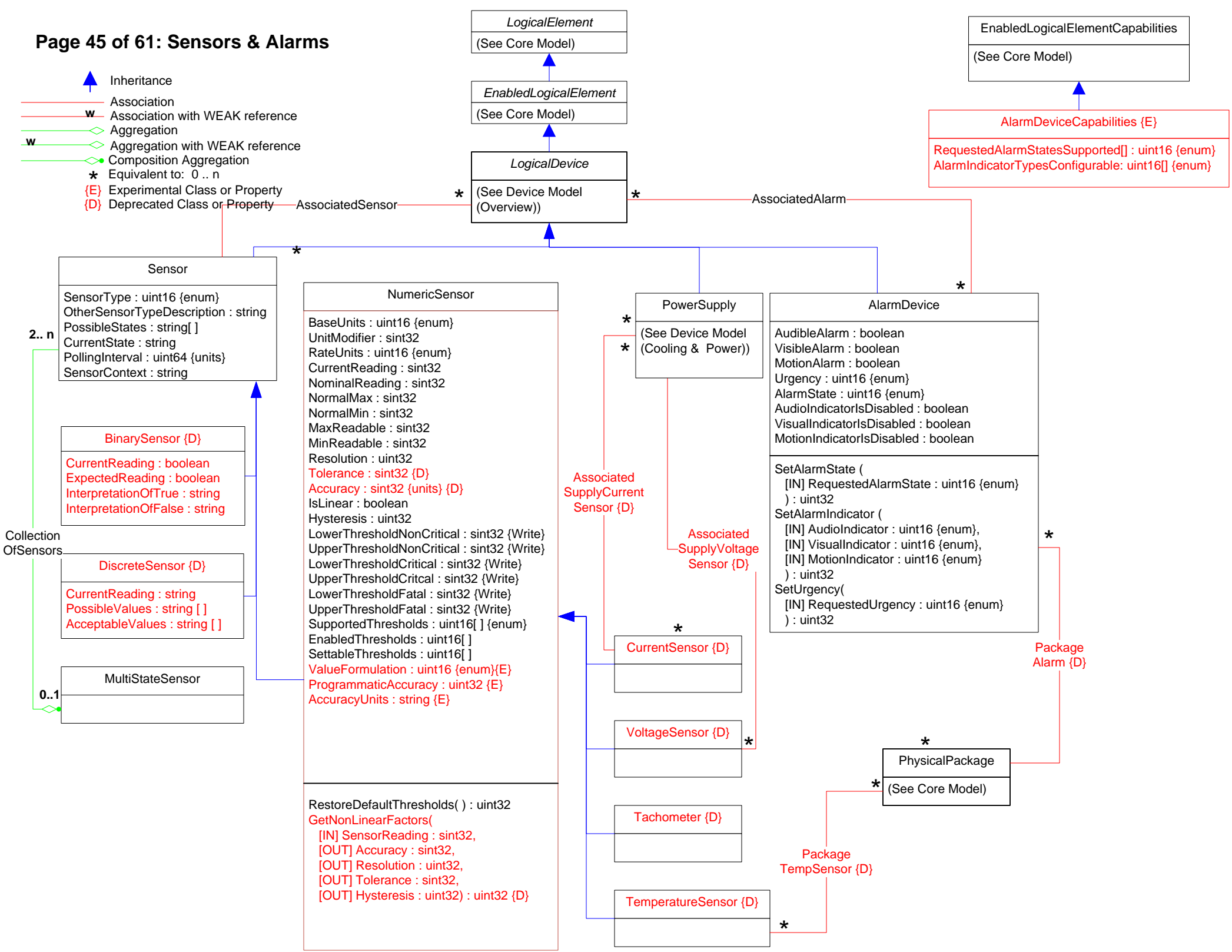





-  Inheritance
-  Association
-  Association with WEAK reference
-  Aggregation
-  Aggregation with WEAK reference
-  Composition Aggregation
-  Equivalent to: 0 .. n
-  Experimental Class or Property
-  Deprecated Class or Property



-  Inheritance
-  Association
-  Association with WEAK reference
-  Aggregation
-  Aggregation with WEAK reference
-  Composition Aggregation
-  Equivalent to: 0 .. n

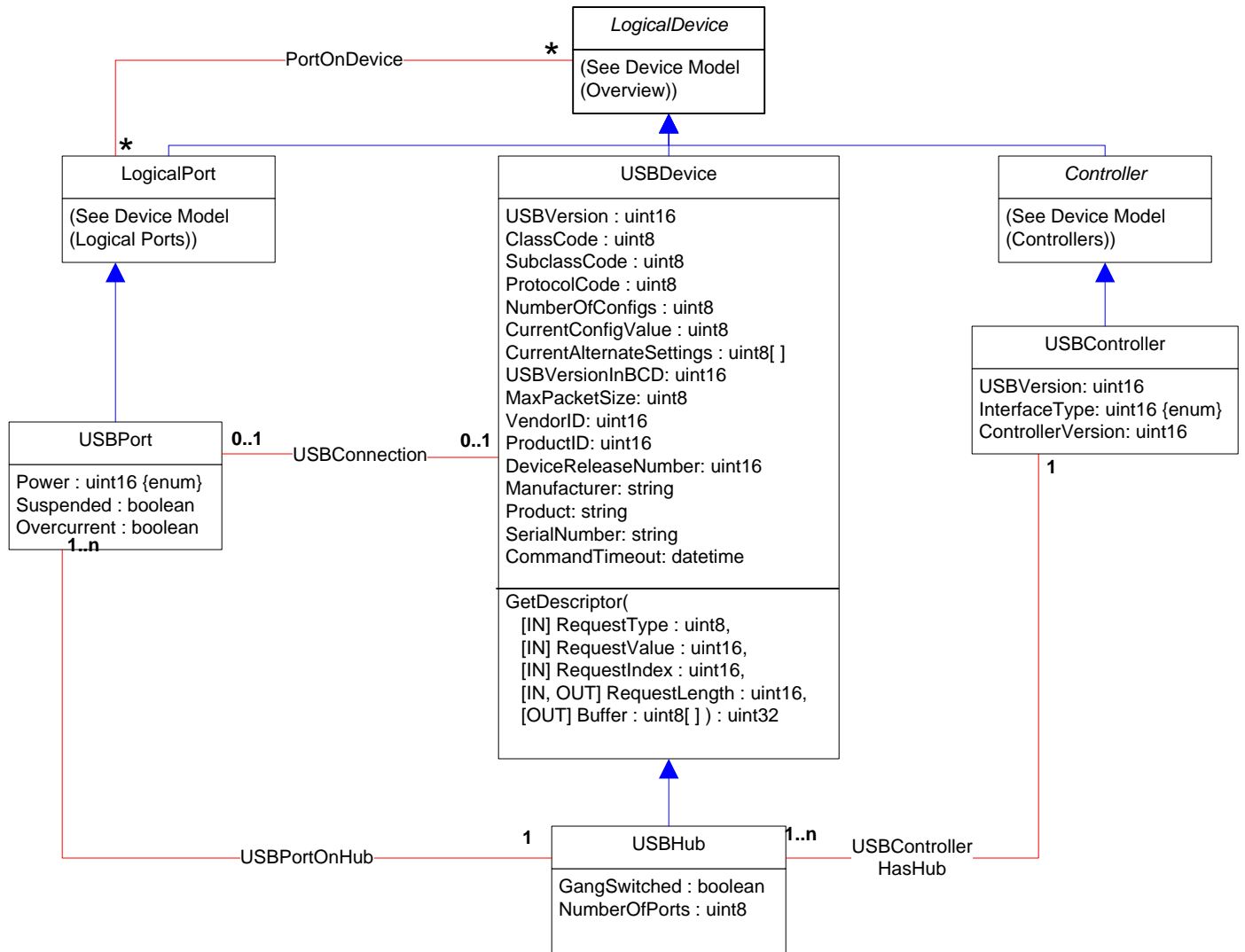





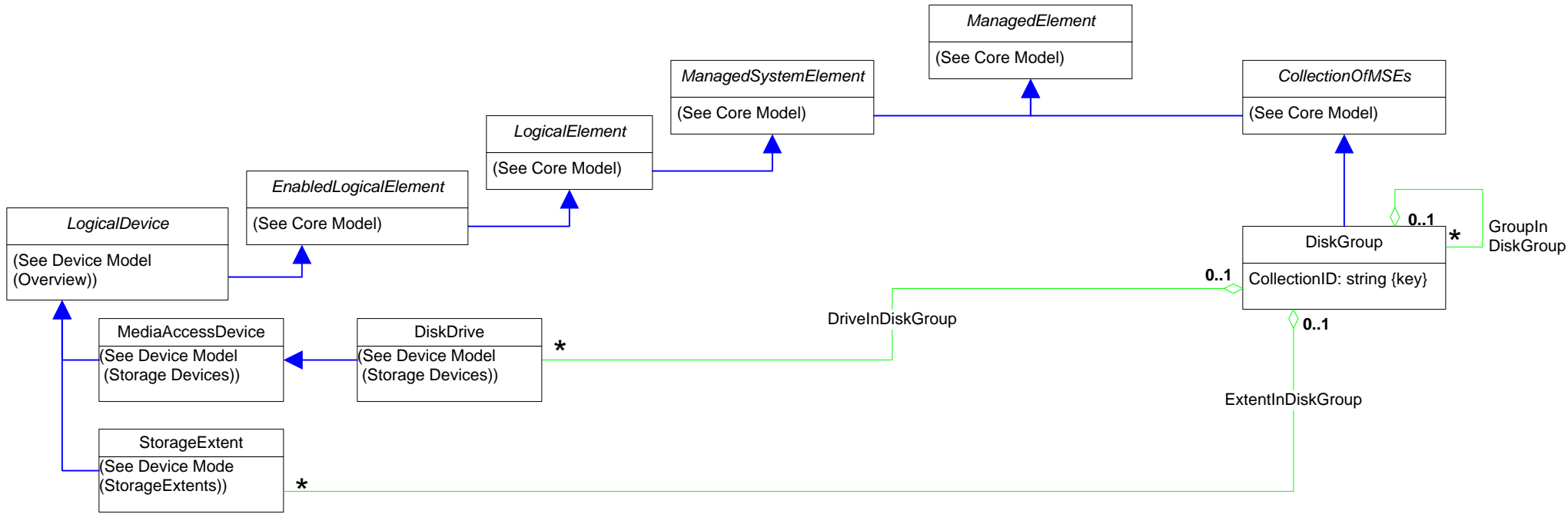

Page 47 of 61: Disk Group







- ▲ Inheritance
- Association
- w Association with WEAK reference
- ◇ Aggregation
- w ◇ Aggregation with WEAK reference
- ◇ Composition Aggregation
- * Equivalent to: 0..n

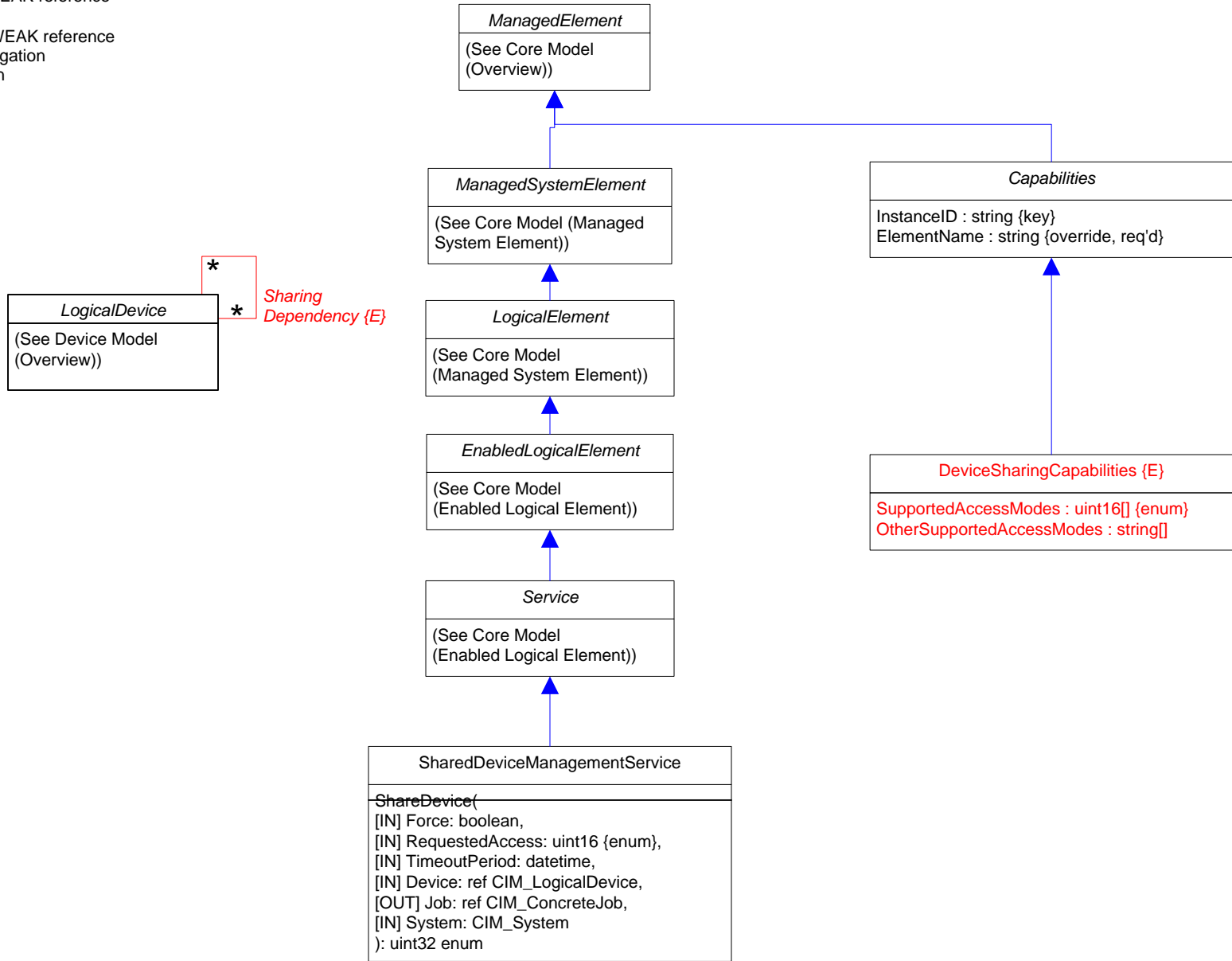





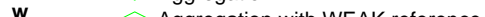
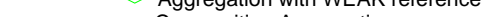



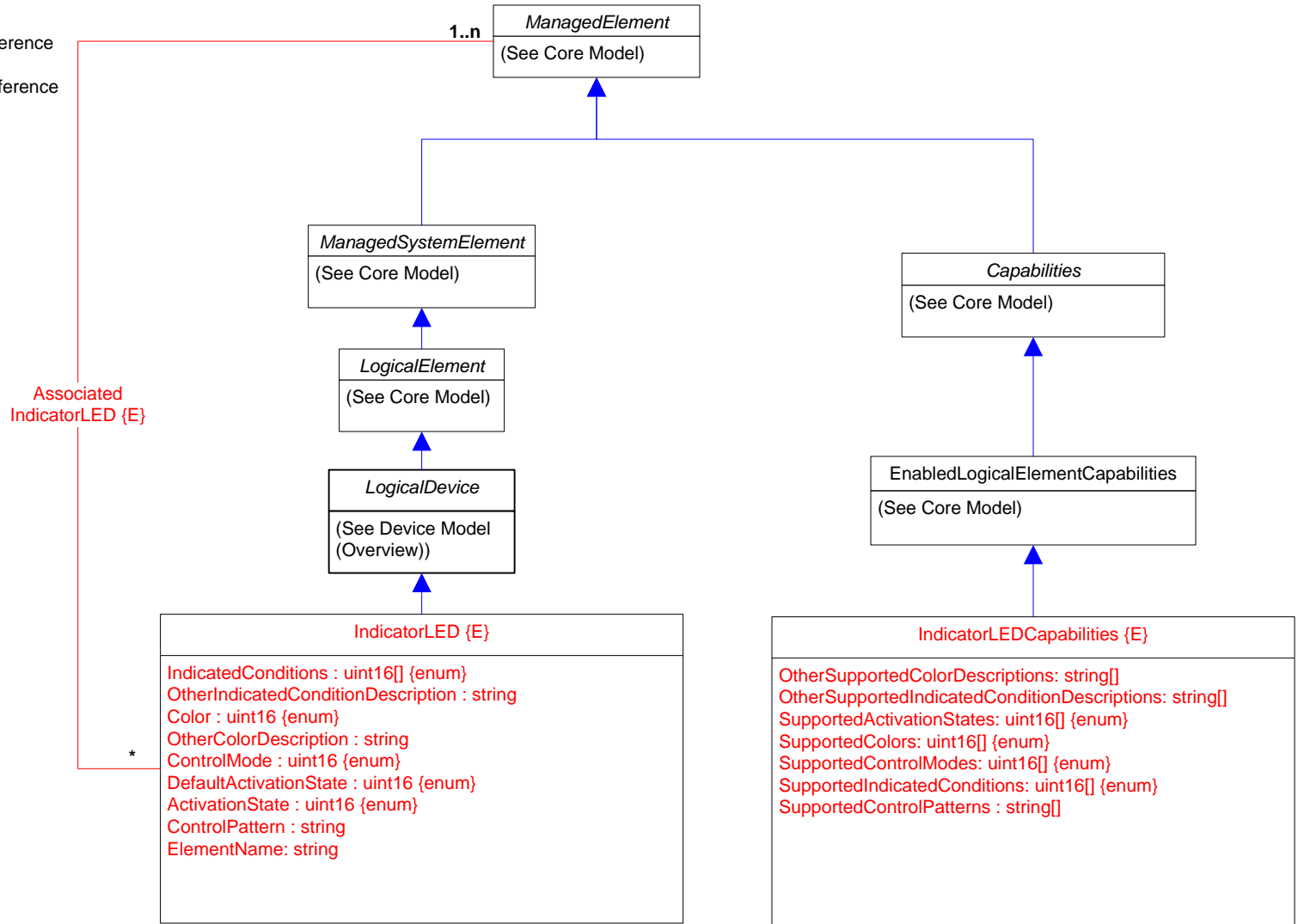

Page 48 of 61: Device Sharing

-  Inheritance
-  Association
-  Association with WEAK reference
-  Aggregation
-  Aggregation with WEAK reference
-  Composition Aggregation
-  Equivalent to: 0..n



-  Inheritance
-  Association
-  Association with WEAK reference
-  Aggregation
-  Aggregation with WEAK reference
-  Composition Aggregation
-  Equivalent to: 0 .. n



-  Inheritance
-  Association
-  Association with WEAK reference
-  Aggregation
-  Aggregation with WEAK reference
-  Composition Aggregation
-  Equivalent to: 0 .. n
-  Experimental Class or Property
-  Deprecated Class or Property

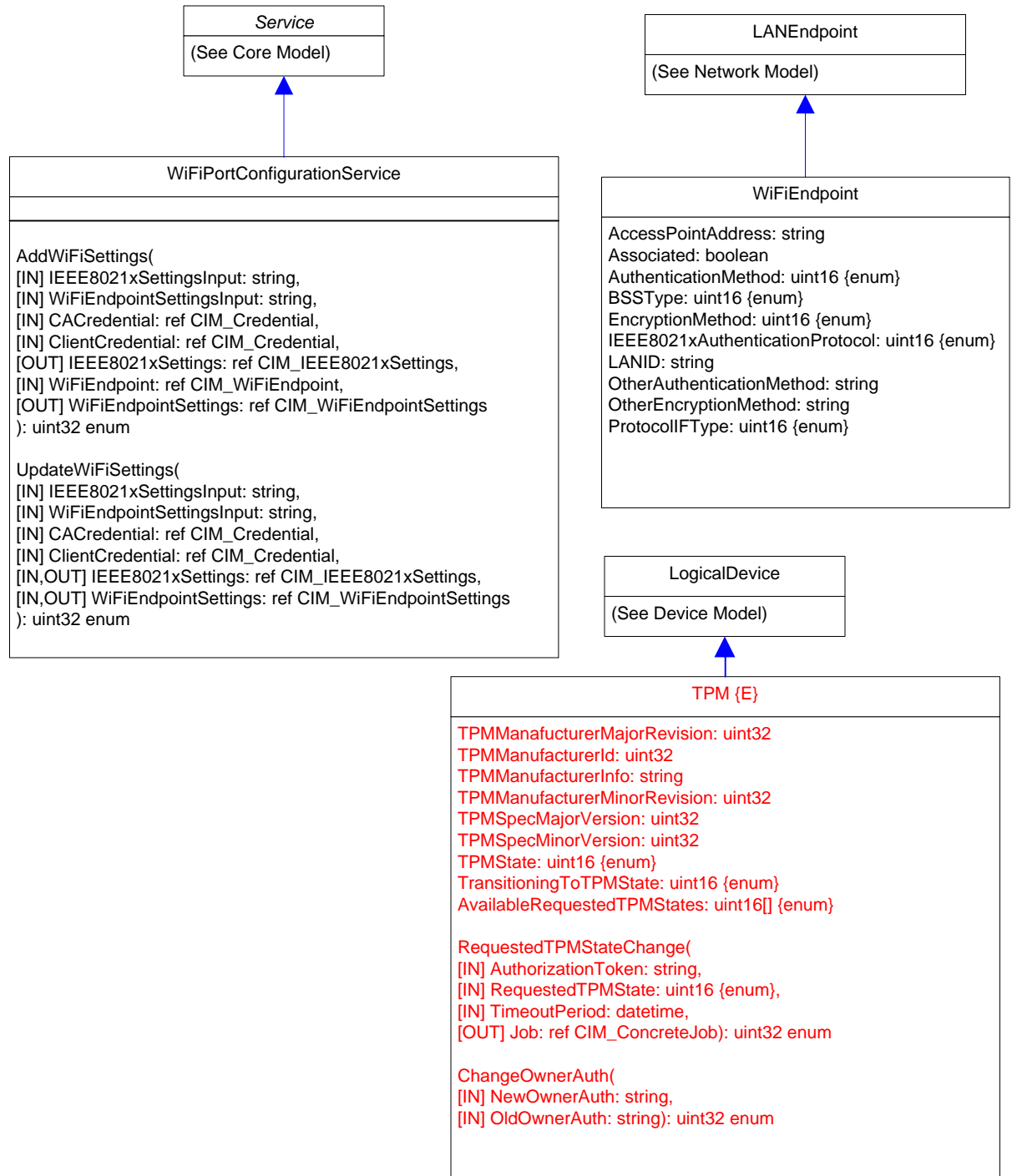
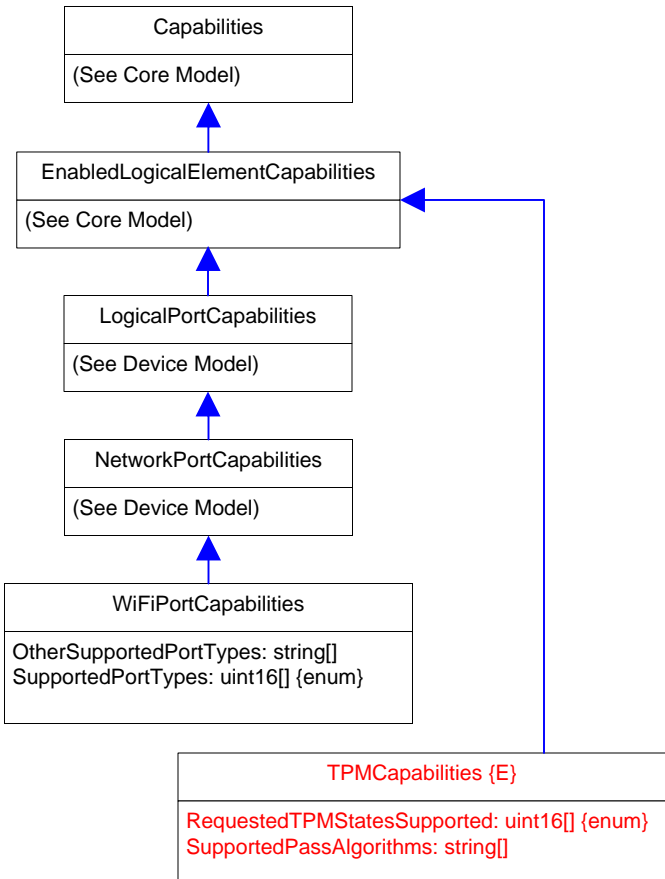

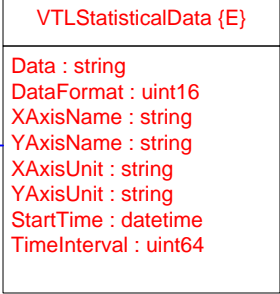
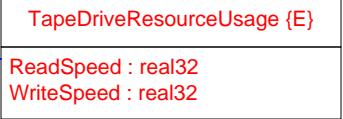
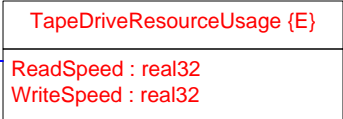
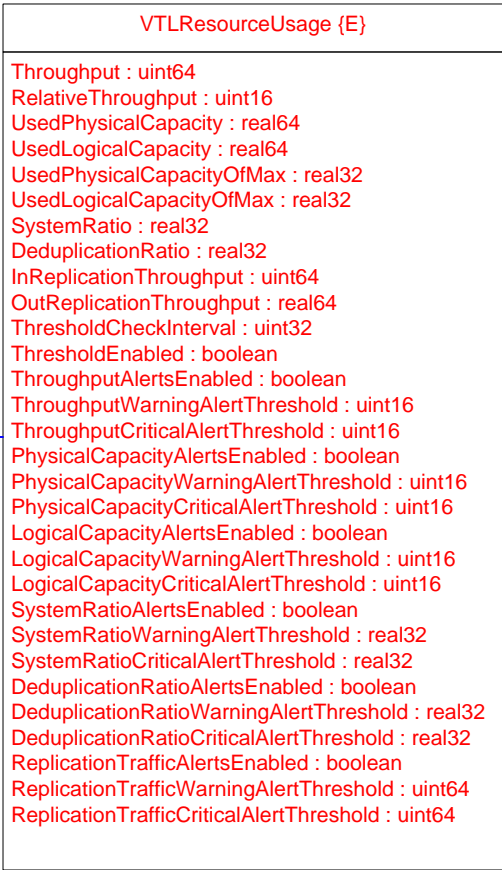
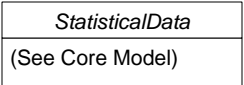
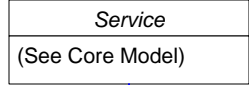

Page 52 of 61: Dependency (1)

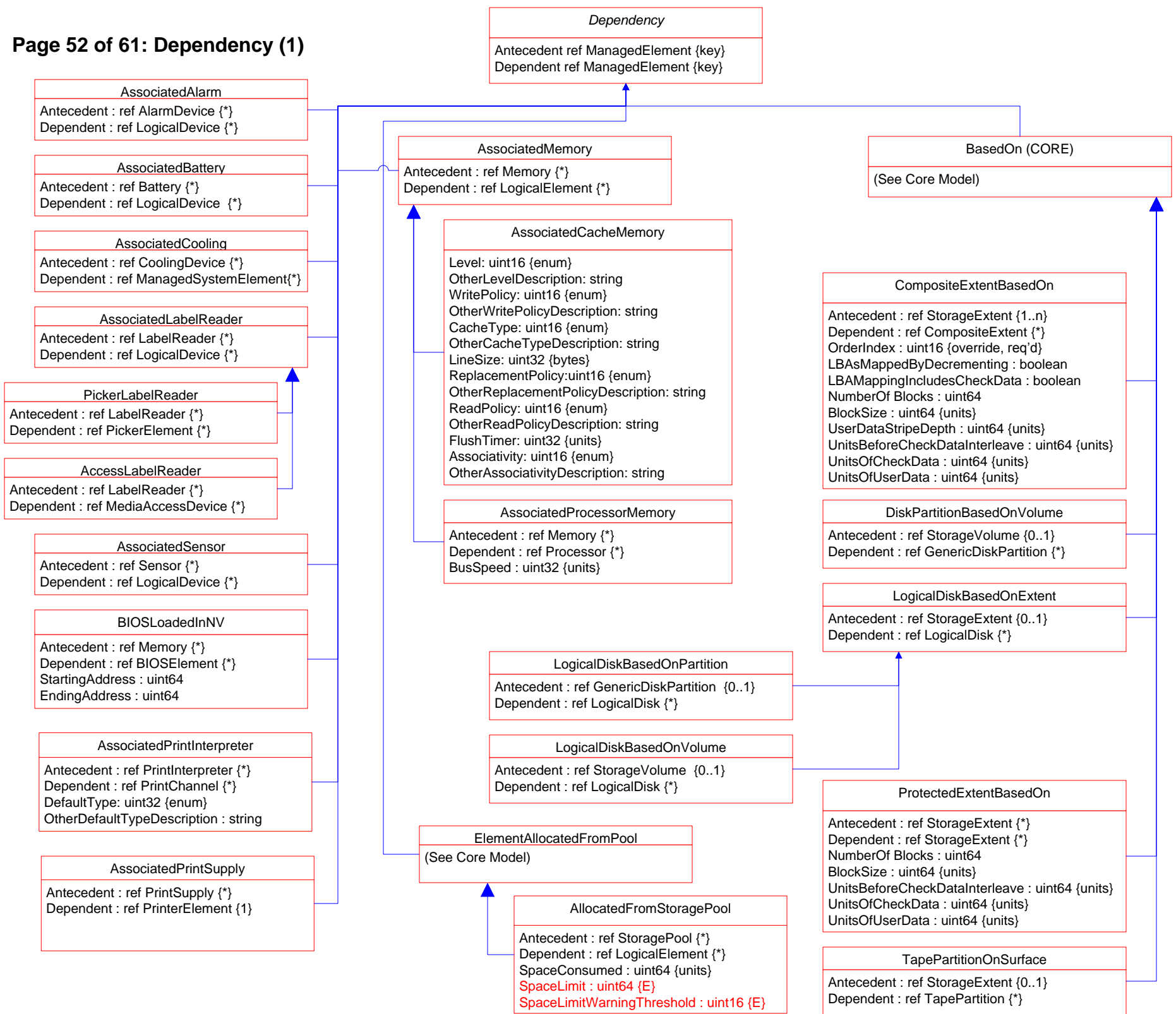

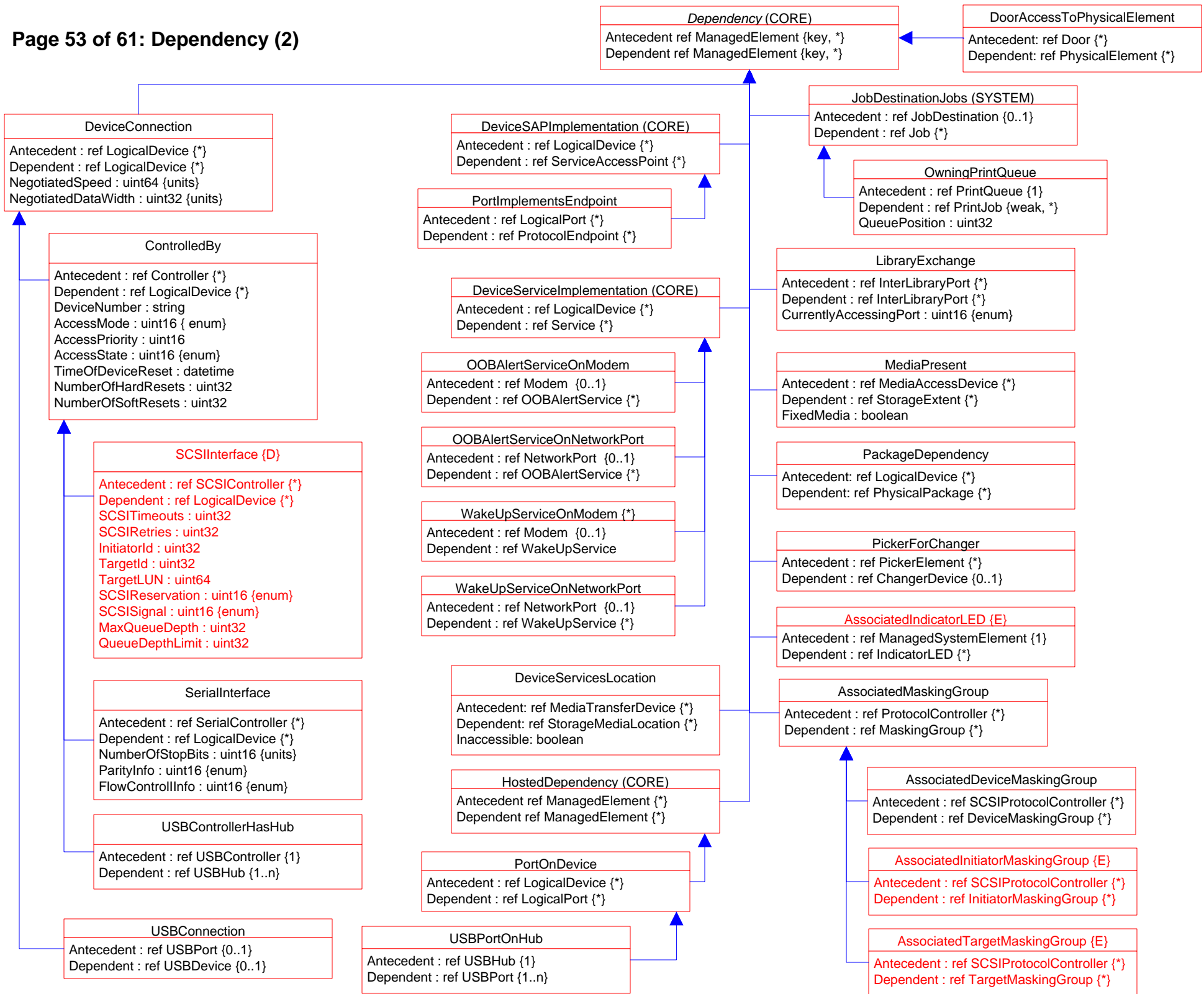

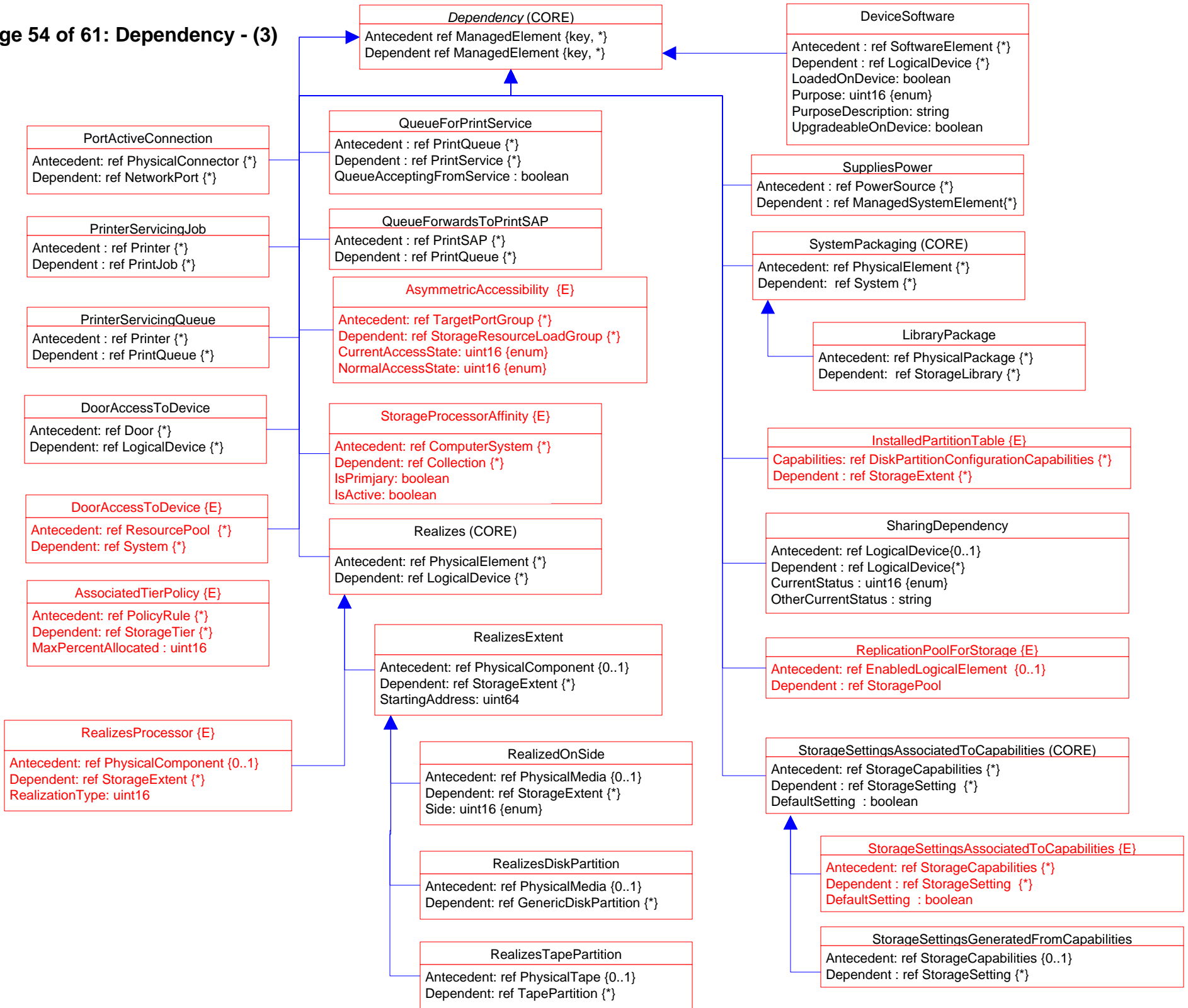

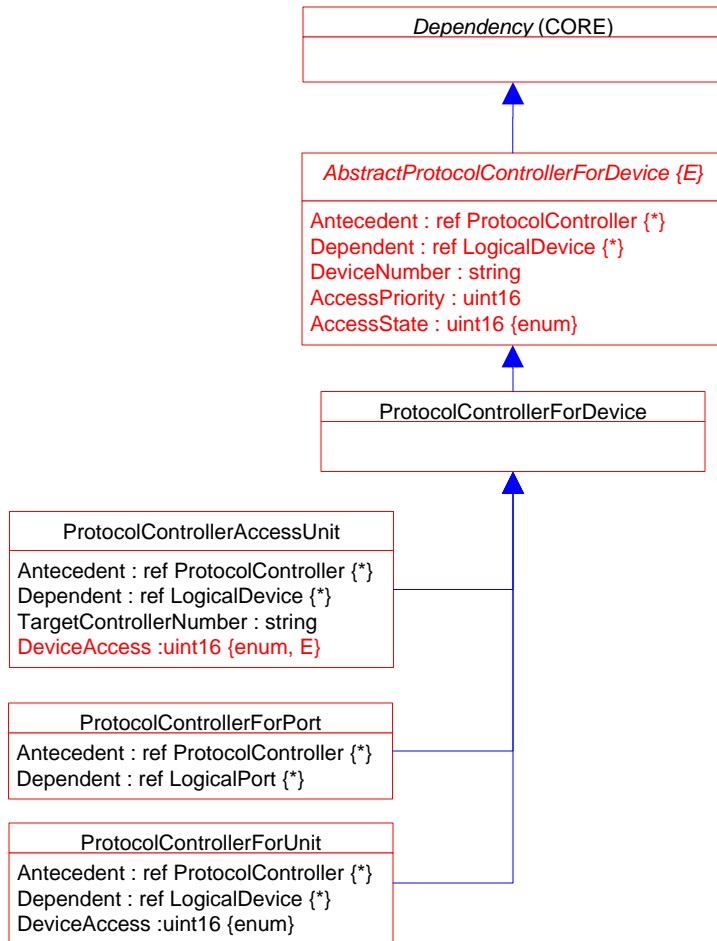

Page 56 of 61: Aggregation Deprecation

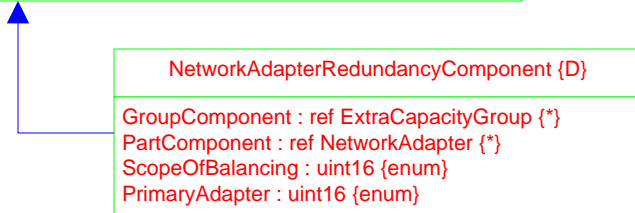
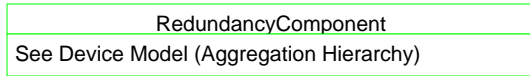
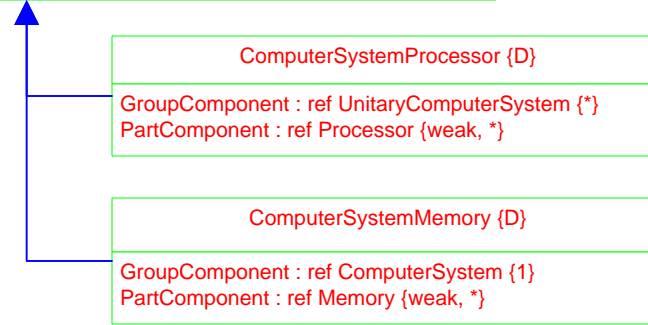
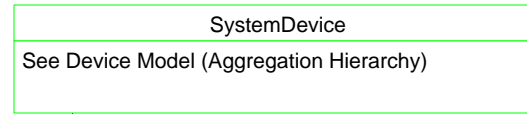
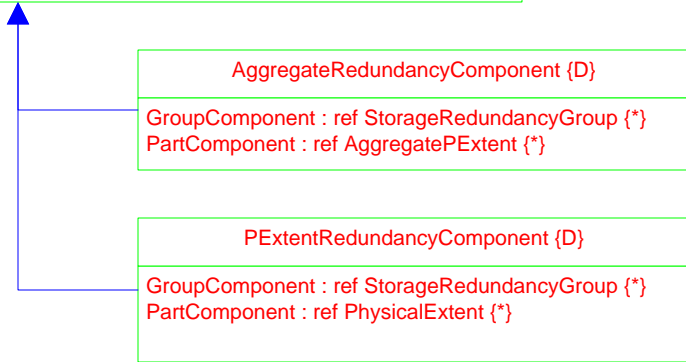
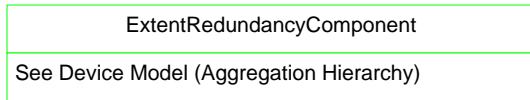

Page 57 of 61: Association Hierarchy

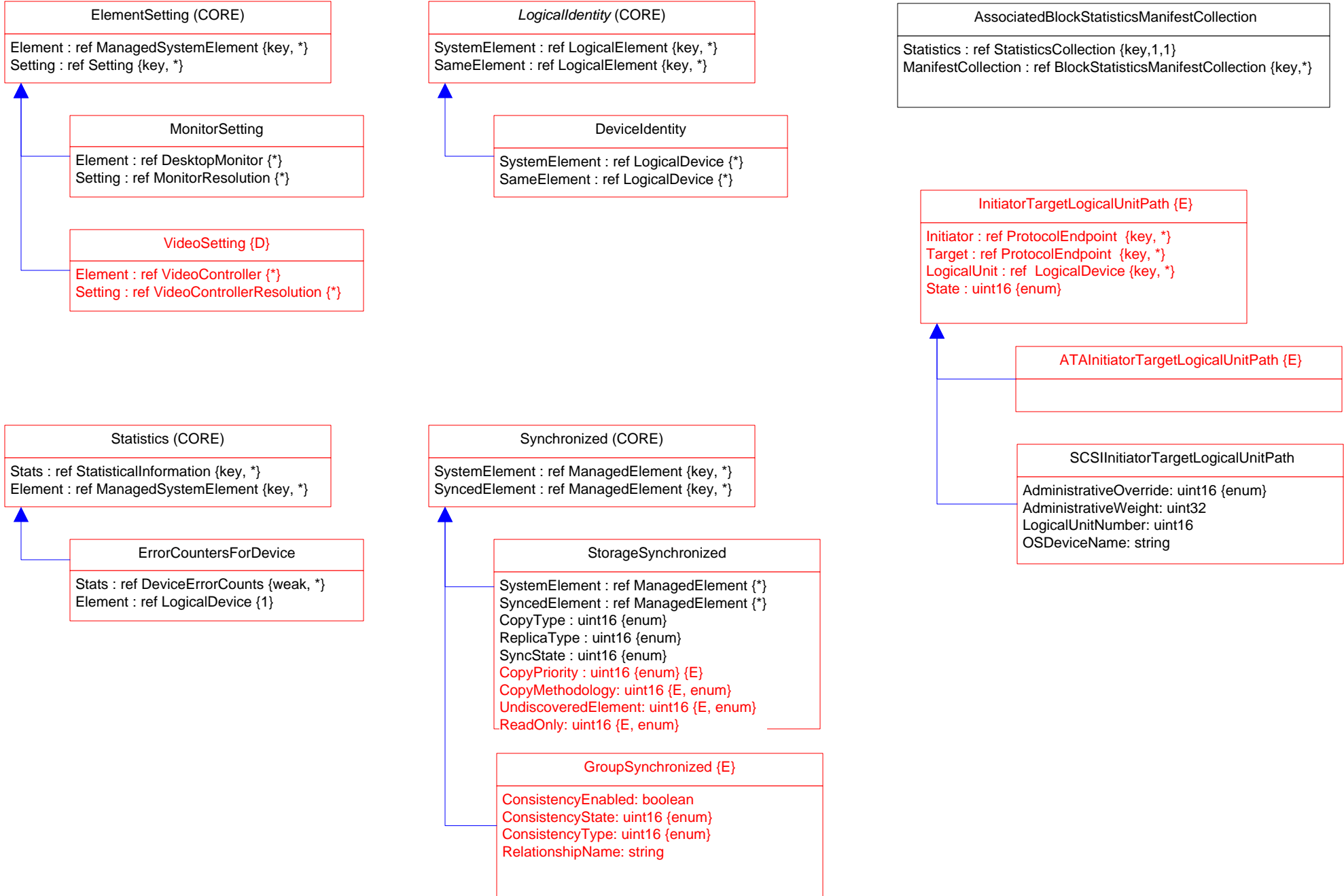

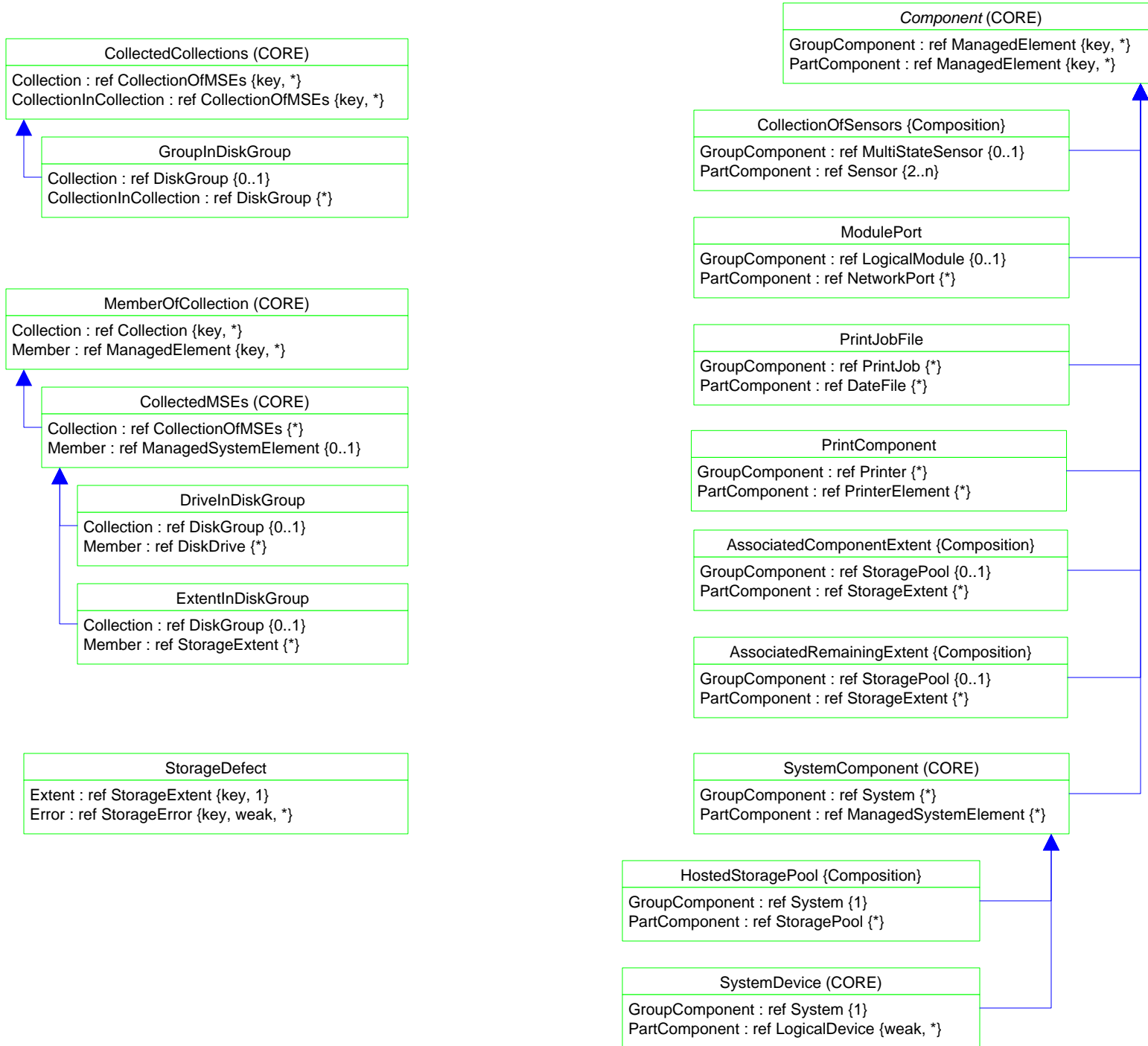

Page 59 of 61: Association Deprecation

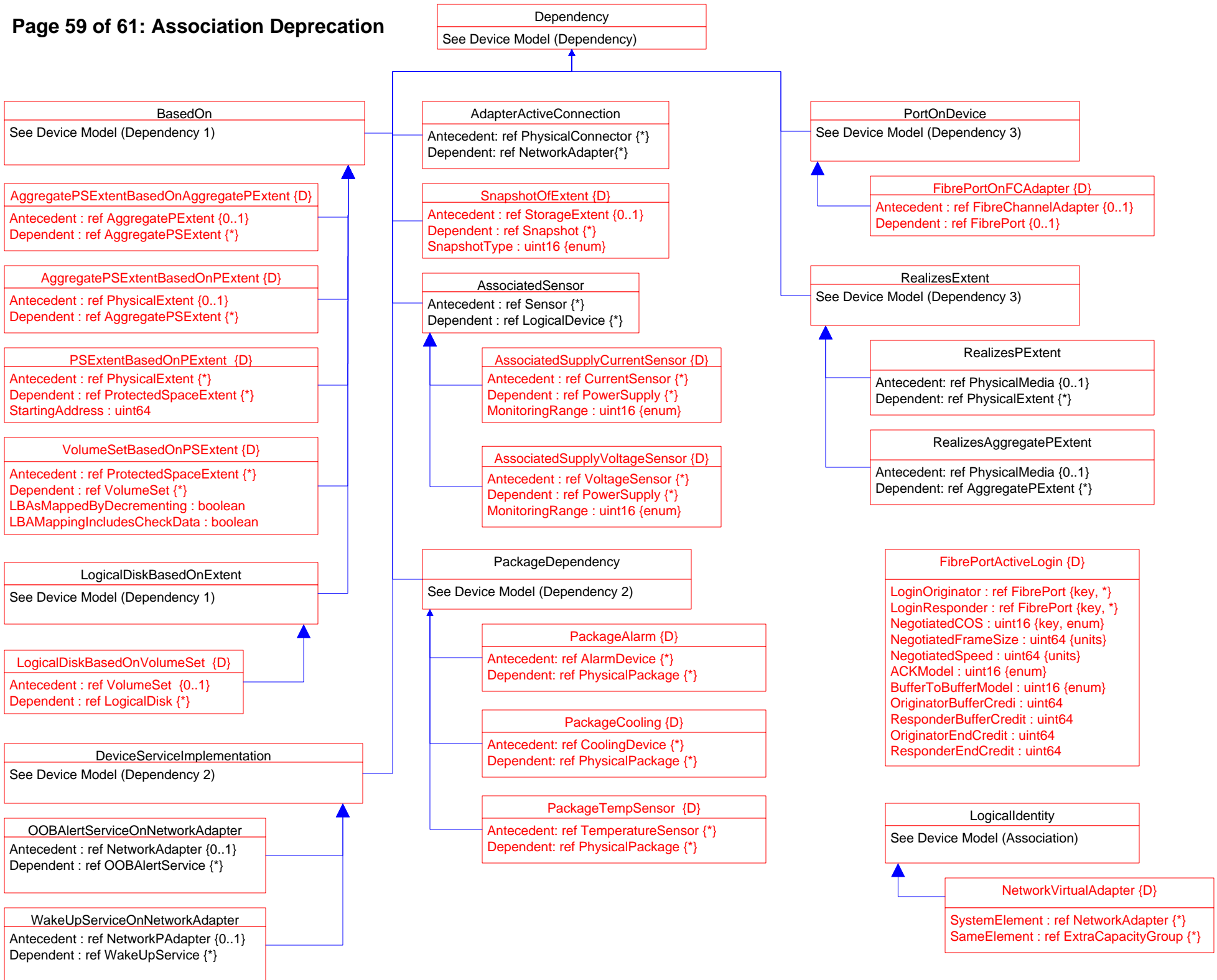

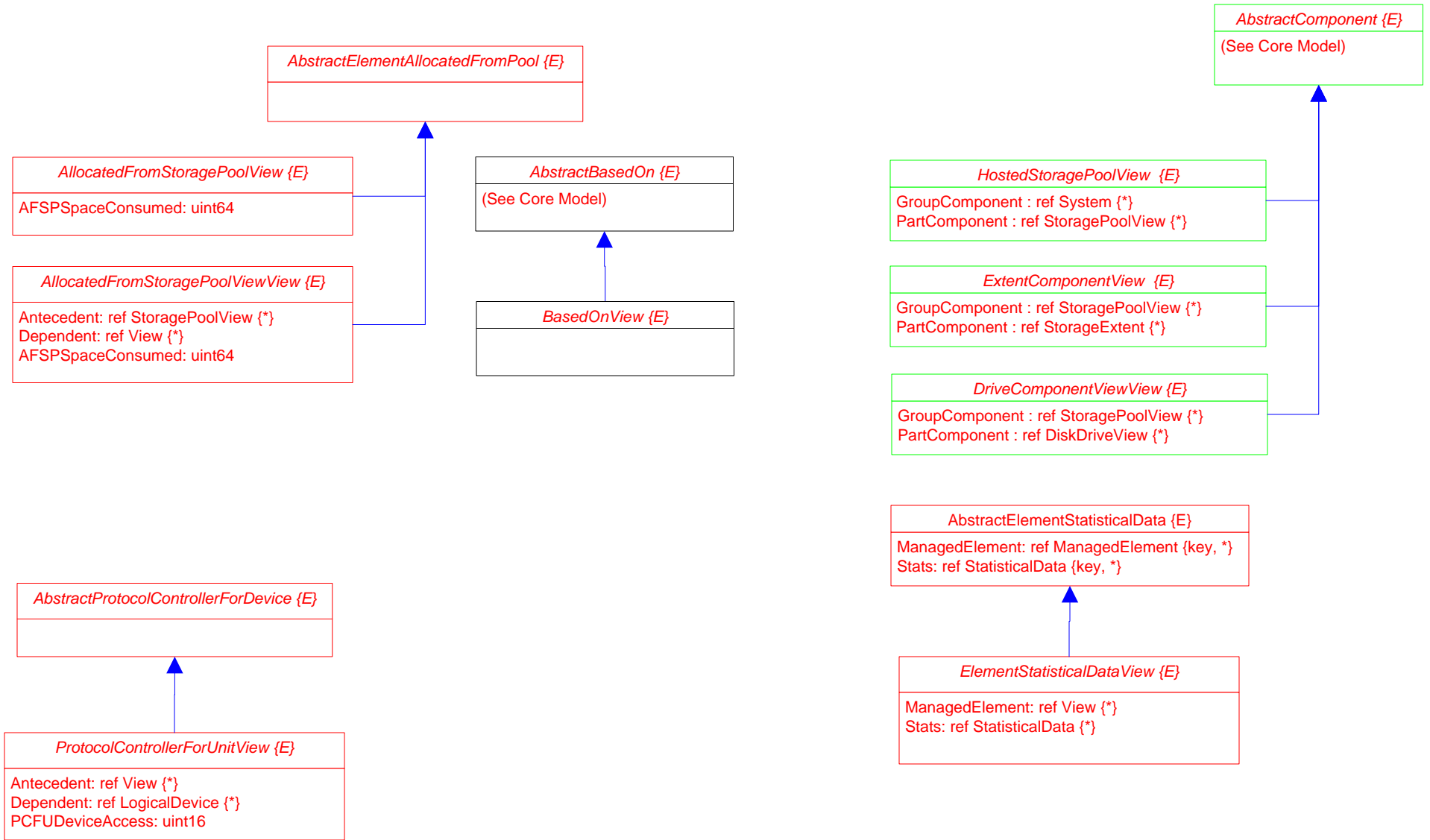

MaskingMappingExposedDeviceView {E}

ProtocolEndpoint: ref ProtocolEndpoint {*}
LogicalDevice: ref LogicalDevice {*}
SPCSystemCreationClassName: string
SPCSystemName: string
SPCCreationClassName: string
SPCDeviceID: string
PCFUDeviceNumber: string
PCFUDeviceAccess: uint16

MaskingMapView {E}

StorageHardwareID: ref StorageHardwareID{*}
LogicalDevice: ref LogicalDevice {*}
ProtocolEndpoint: ref ProtocolEndpoint{*}
SHIDStorageID: string
SHIDIDType: uint16
LDDeviceID: string
SPEPSystemCreationClassName: string
SPEPCreationClassName: string
SPEPSystemName: string
SPEPName: string
SPEPProtocolIFTType:
SPEPOtherTypeDescription: string
SPEPConnectionType:
SPEPRole: uint16
APIInstanceID: string
APPPrivilegeGranted:
APActivities[]: uint16
APElementName: string
SPCSystemCreationClassName: string
SPCCreationClassName: string
SPCSystemName: string
SPCDeviceID: string
PCFUDeviceNumber: string
PCFUDeviceAccess: uint16