

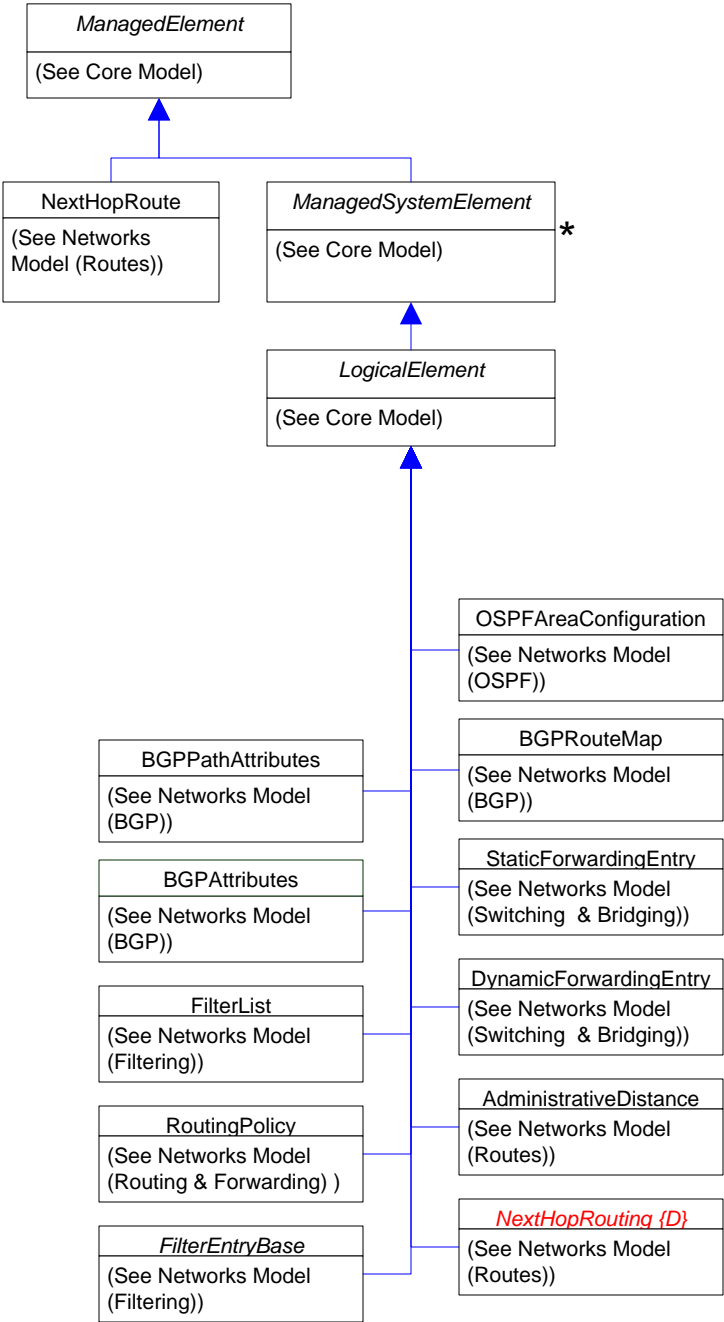













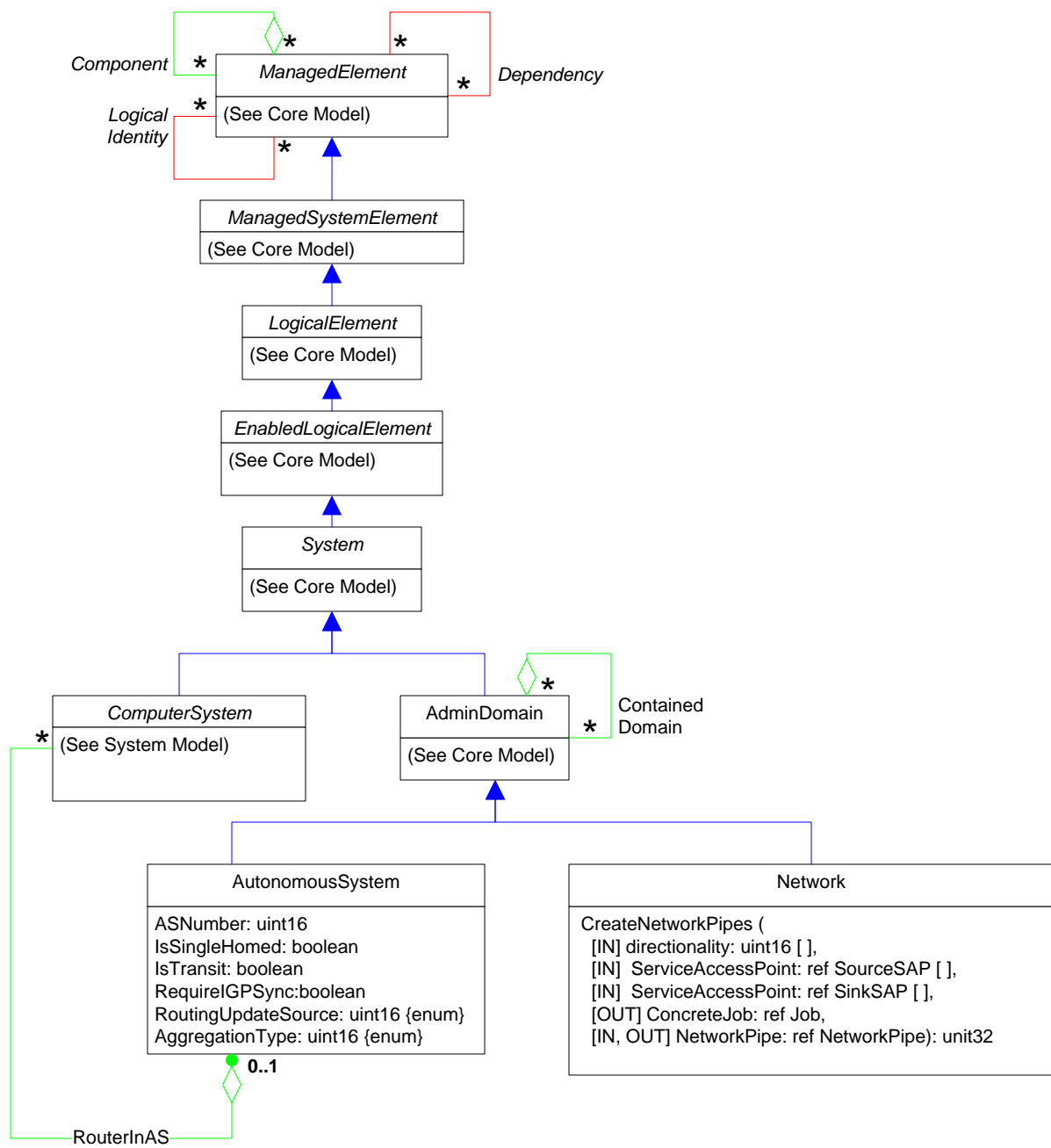

- ▲ Inheritance
- Association
- w Association with WEAK reference
- ◇ Aggregation
- w◇ Aggregation with WEAK reference
- ◇ Composition Aggregation
- * Equivalent to: 0 .. n



-  Inheritance
-  Association
-  Association with WEAK reference
-  Aggregation
-  Aggregation with WEAK reference
-  Composition Aggregation
-  Equivalent to: 0 .. n



-  Inheritance
-  Association
-  Association with WEAK reference
-  Aggregation
-  Aggregation with WEAK reference
-  Composition Aggregation
-  Equivalent to: 0..n

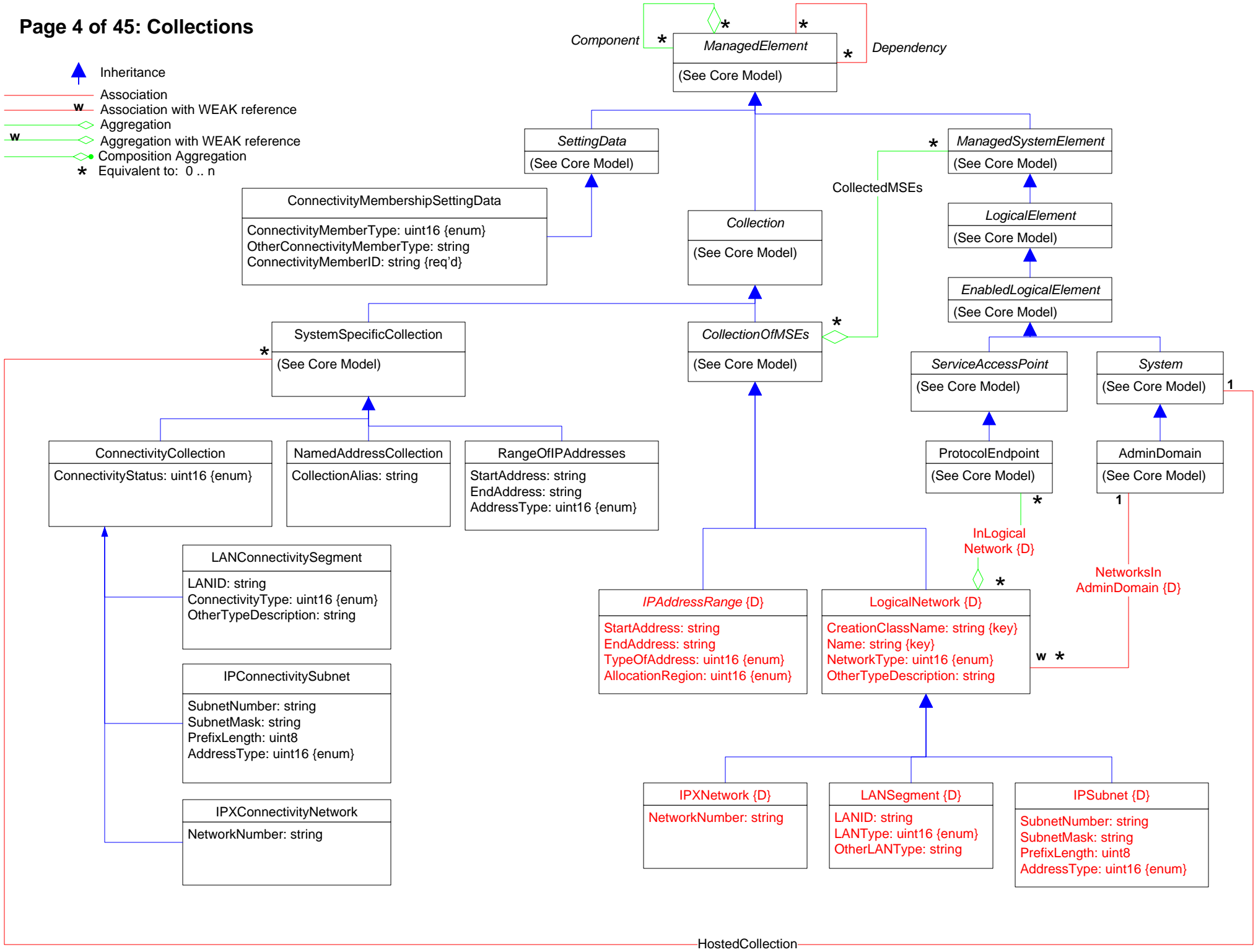

- Inheritance
- Association
- Association with WEAK reference
- Aggregation
- Aggregation with WEAK reference
- Composition Aggregation
- Equivalent to: 0..n

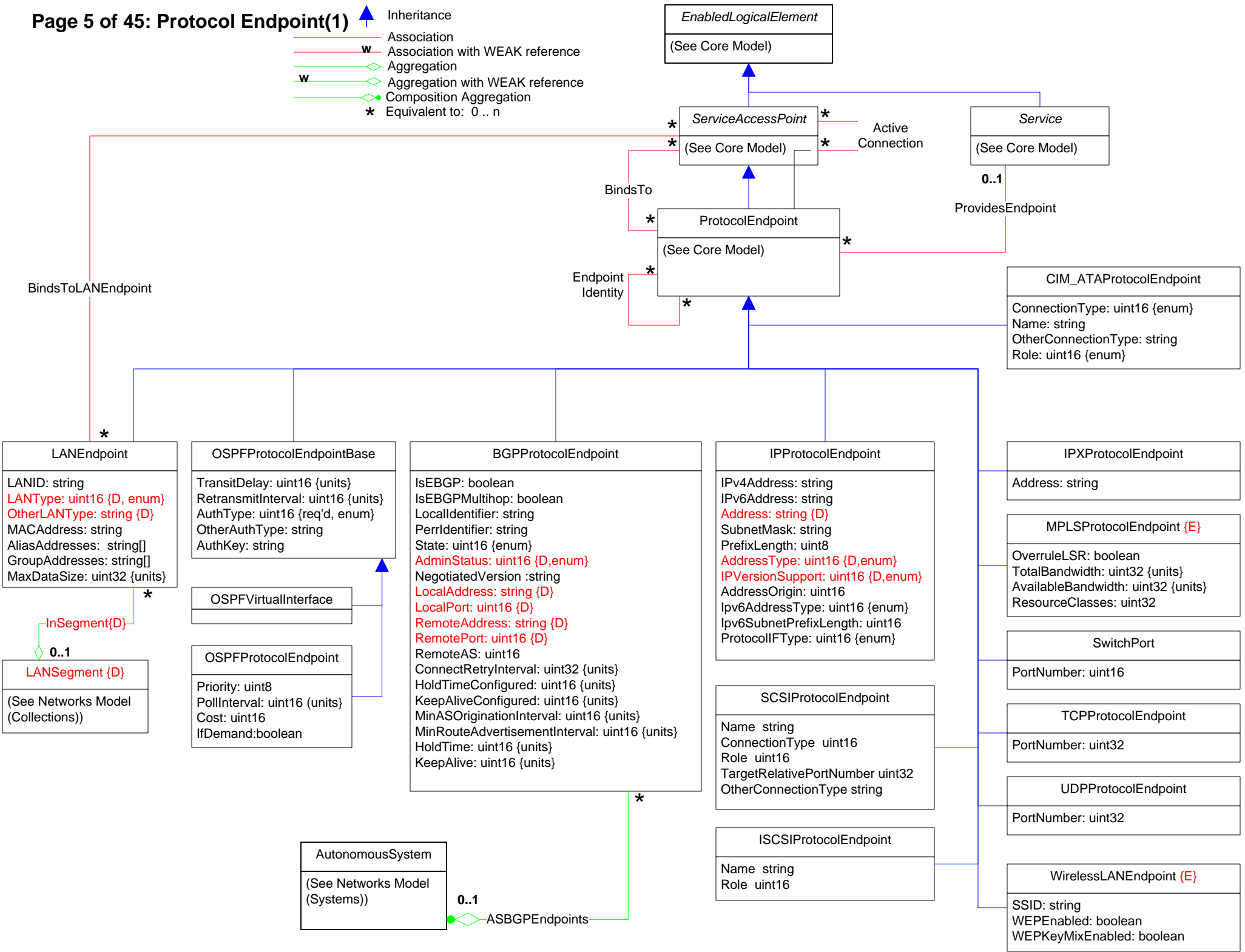

Page 6 of 45: Protocol Endpoint(2)

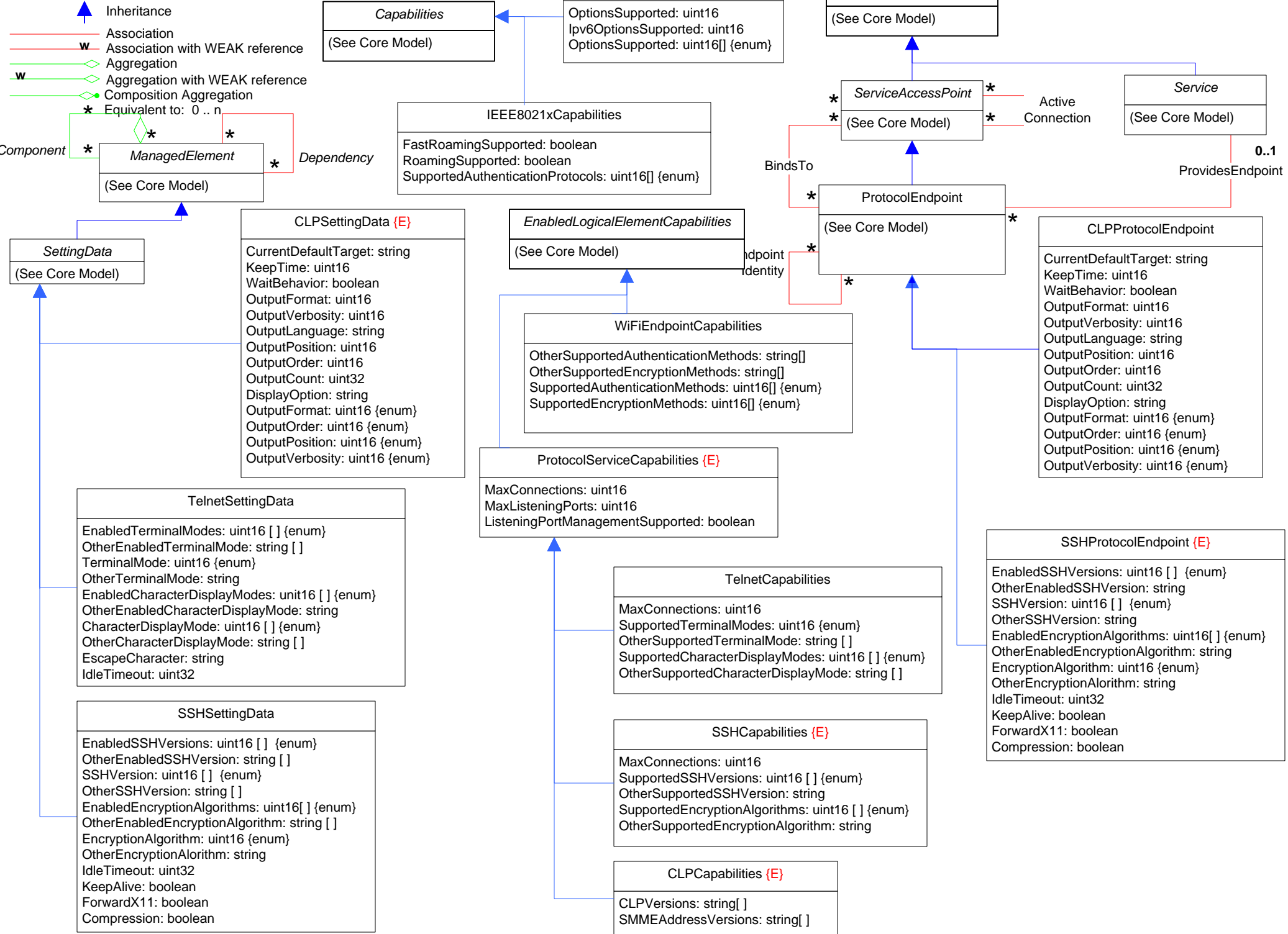

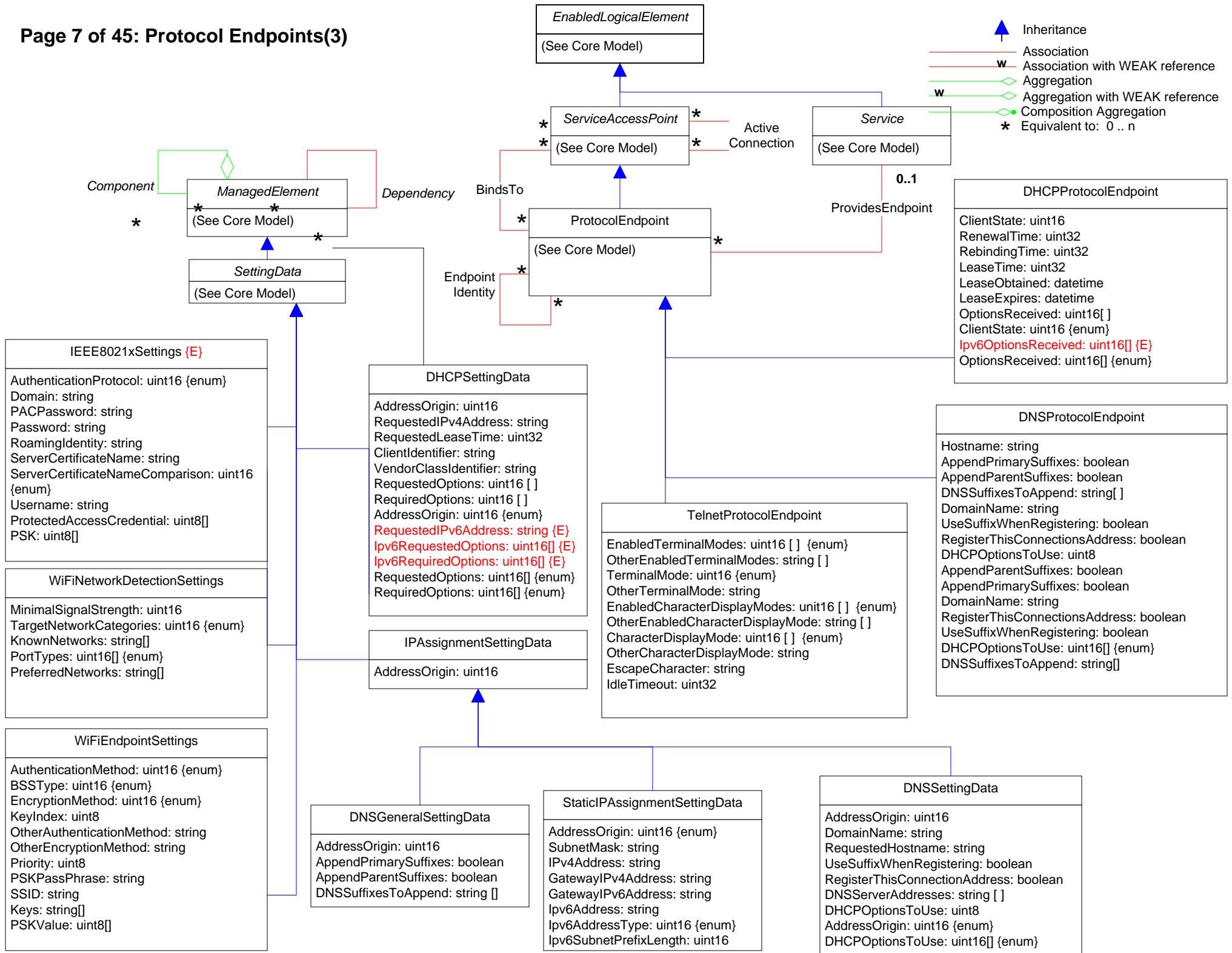





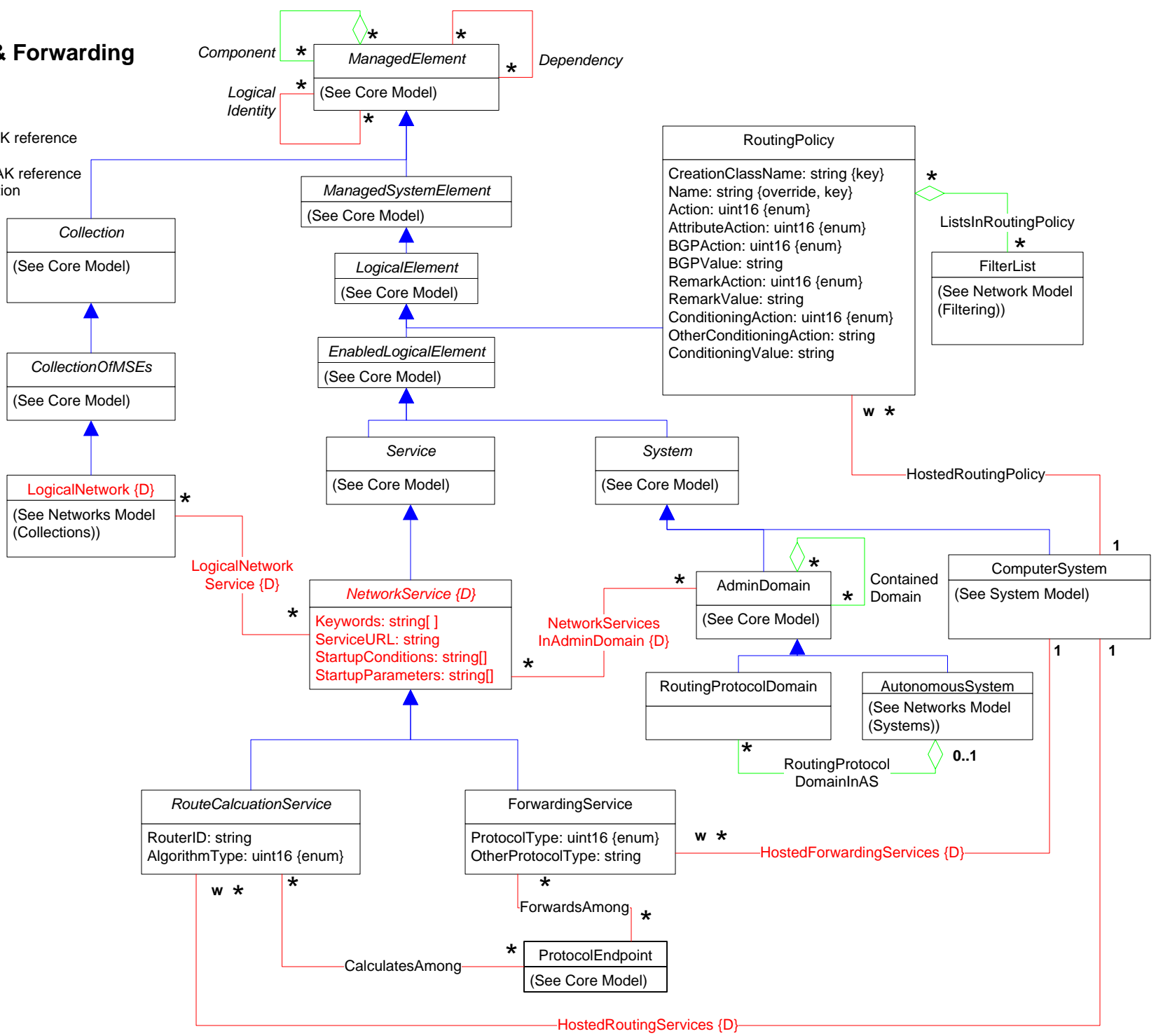

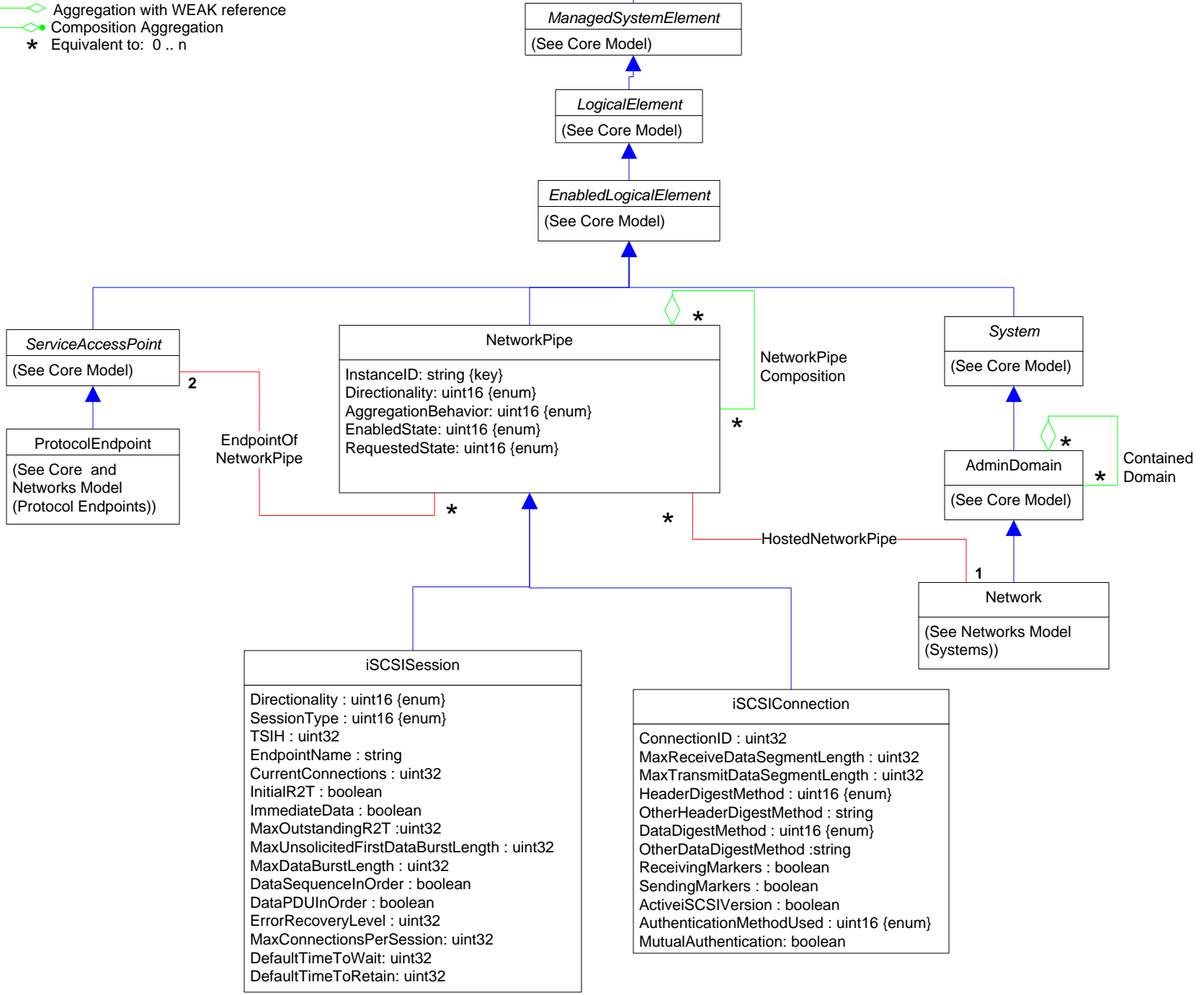
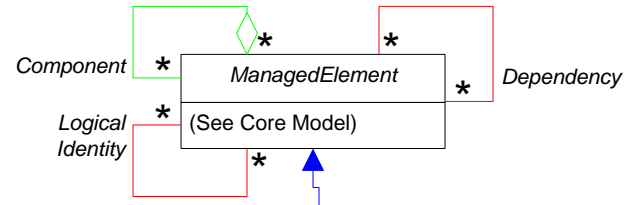

Page 8 of 45: Routing & Forwarding

- Inheritance
- Association
- Association with WEAK reference
- Aggregation
- Aggregation with WEAK reference
- Composition Aggregation
- Equivalent to: 0..n







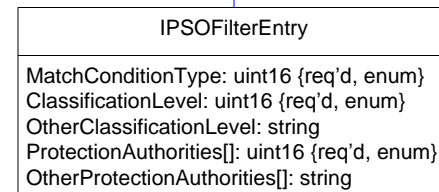
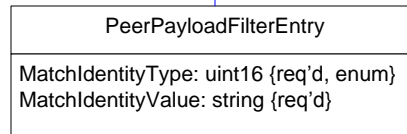
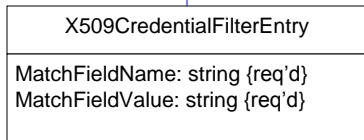
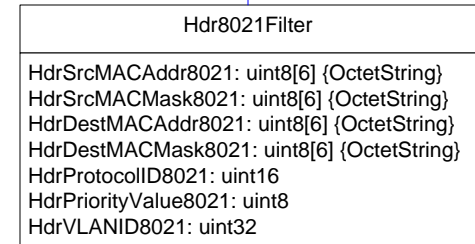
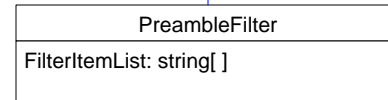
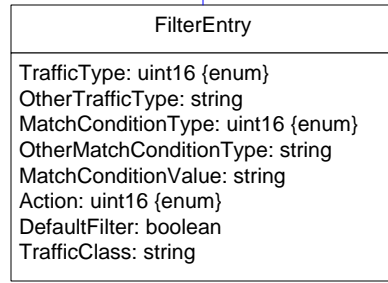
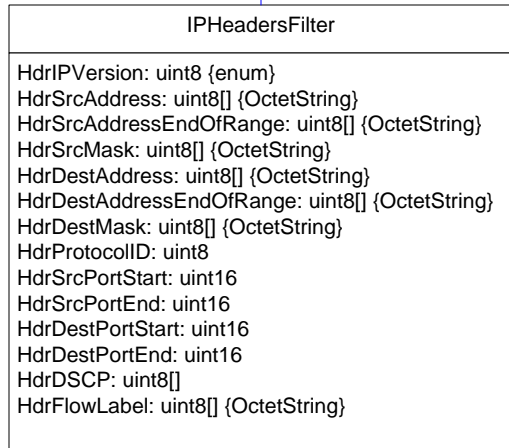
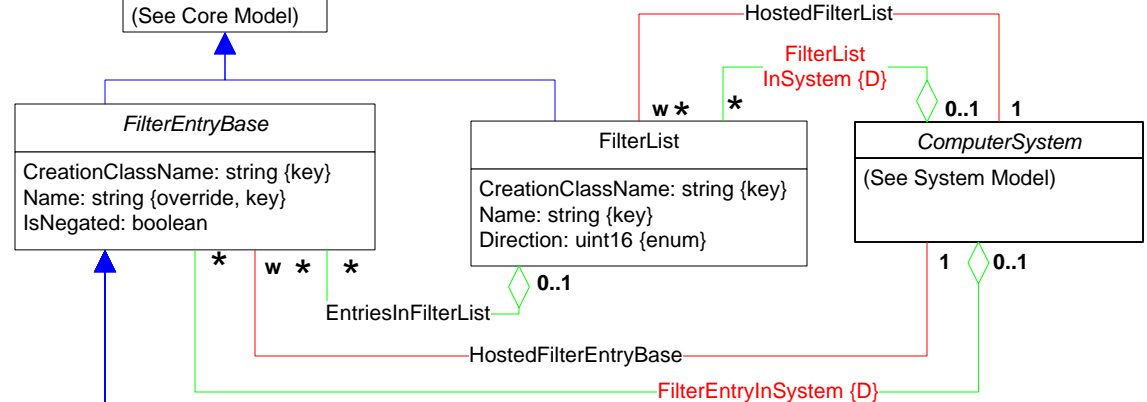
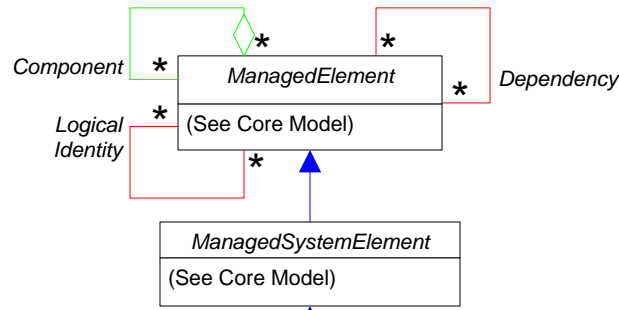

-  Inheritance
- Association
- Association with WEAK reference
- Aggregation
- Aggregation with WEAK reference
- Composition Aggregation
- Equivalent to: 0 .. n



-  Inheritance
-  Association
-  Association with WEAK reference
-  Aggregation
-  Aggregation with WEAK reference
-  Composition Aggregation
-  Equivalent to: 0..n







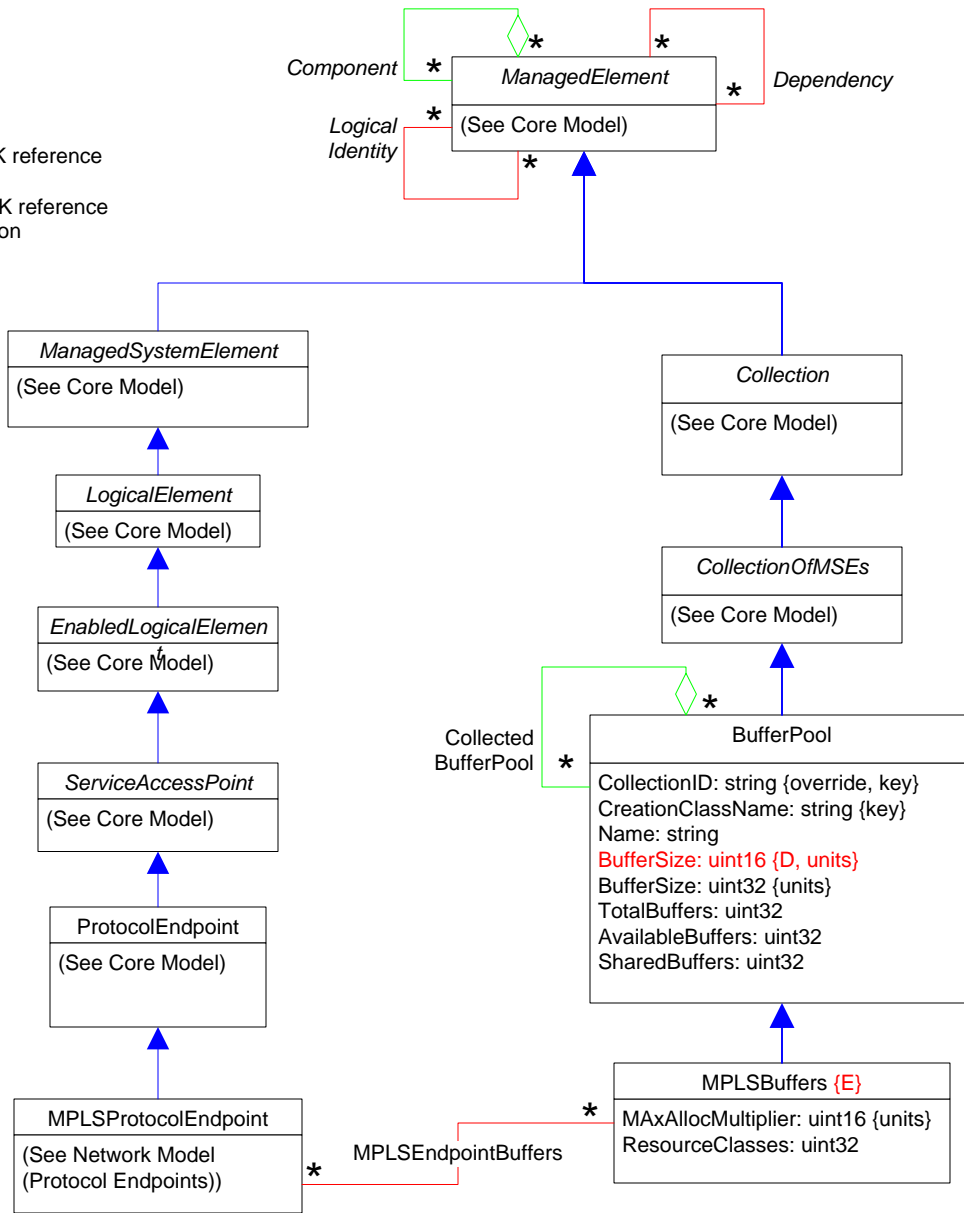

Page 12 of 45: Buffers







-  Inheritance
-  Association
-  Association with WEAK reference
-  Aggregation
-  Aggregation with WEAK reference
-  Composition Aggregation
-  Equivalent to: 0..n

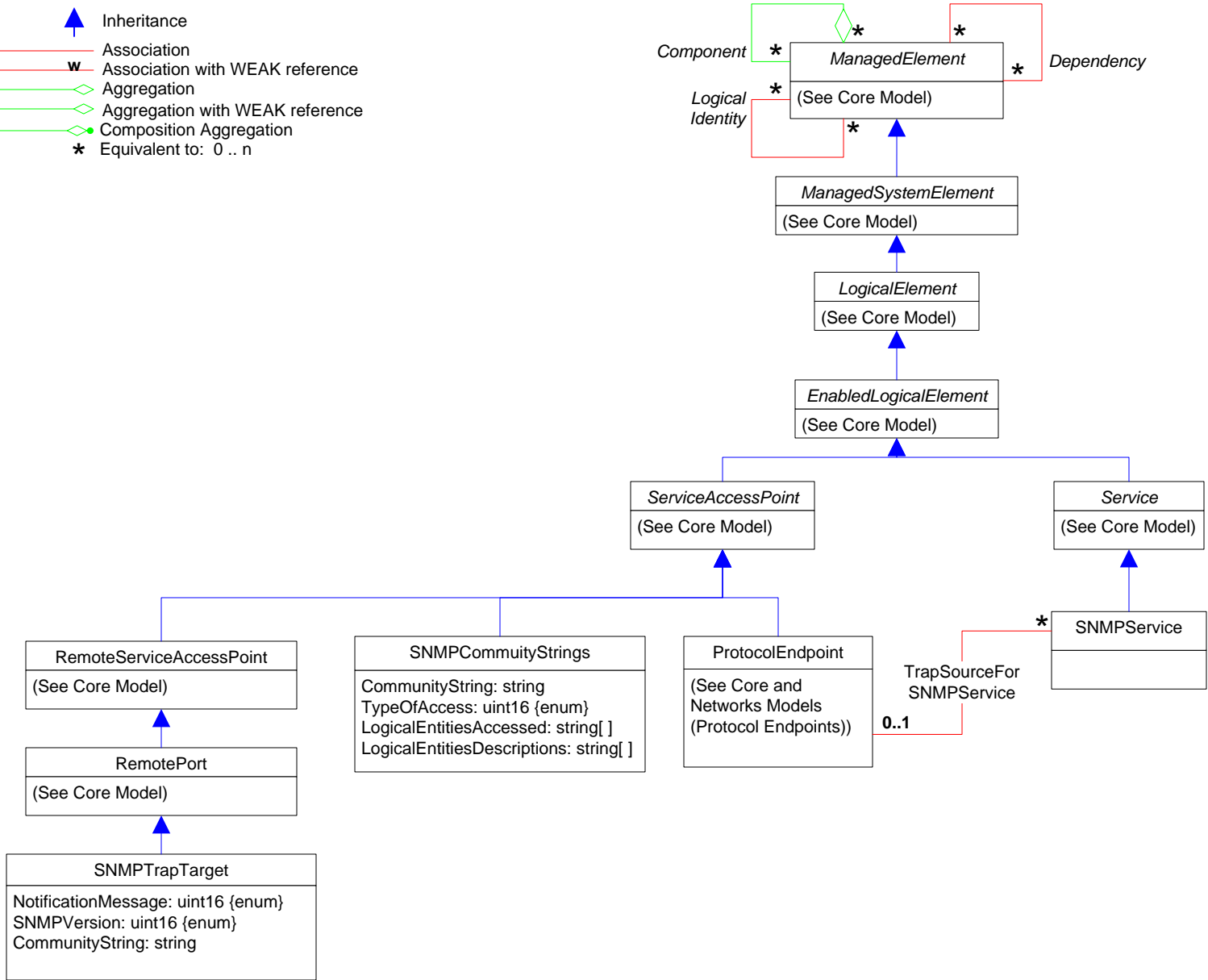

Page 13 of 45: SNMP

-  Inheritance
-  Association
-  Association with WEAK reference
-  Aggregation
-  Aggregation with WEAK reference
-  Composition Aggregation
-  Equivalent to: 0..n



-  Inheritance
-  Association
-  Association with WEAK reference
-  Aggregation
-  Aggregation with WEAK reference
-  Composition Aggregation
-  Equivalent to: 0..n

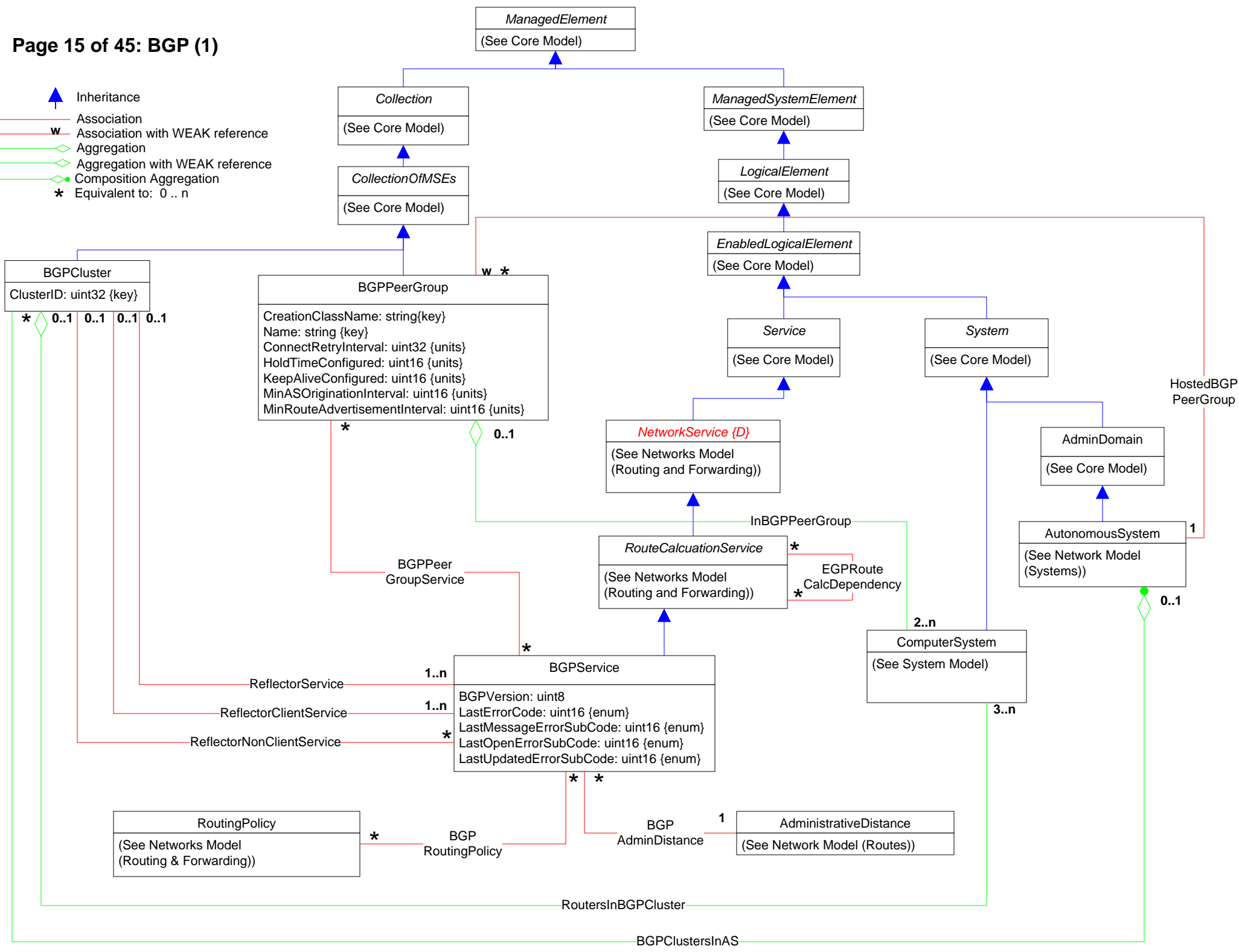

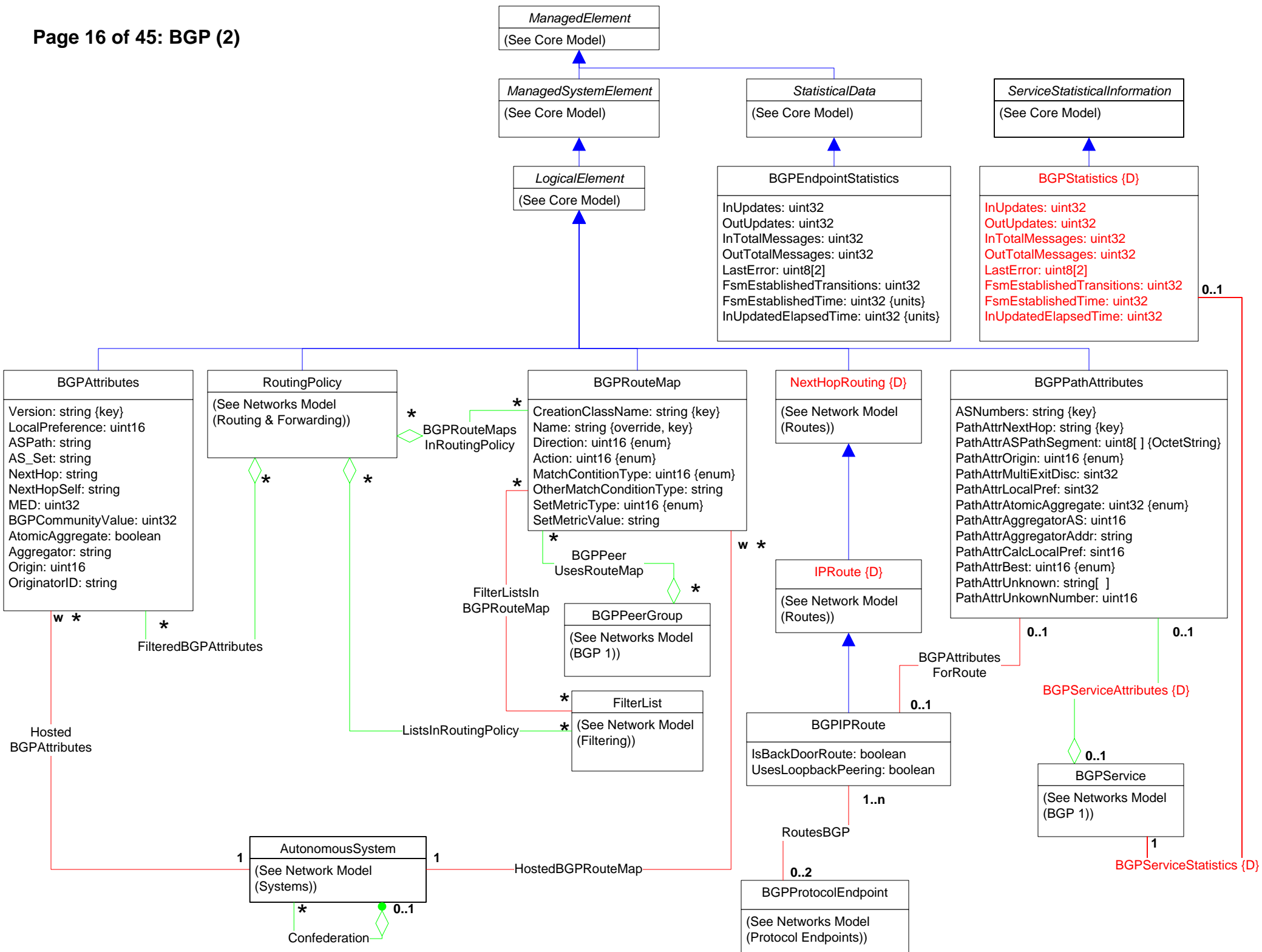

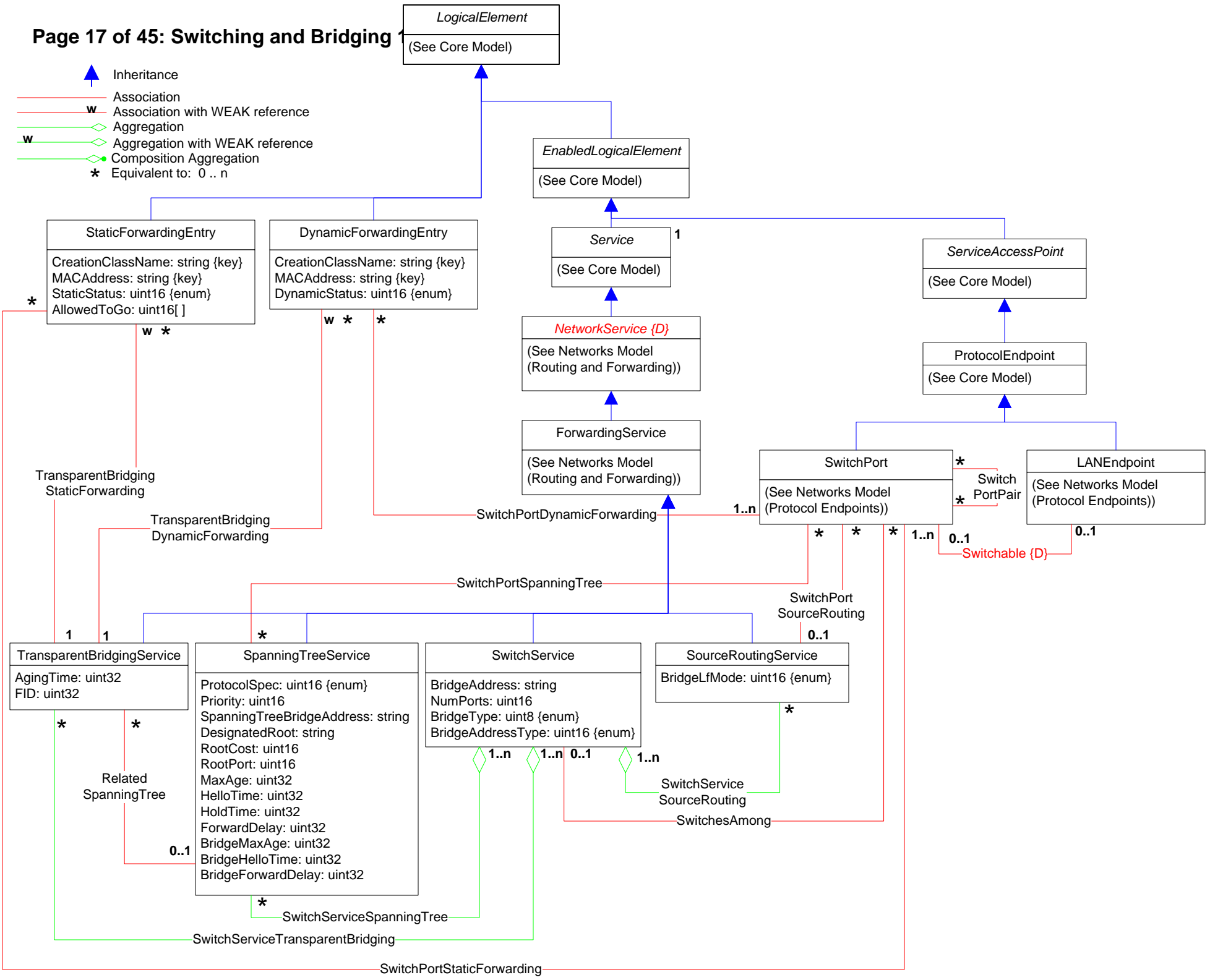

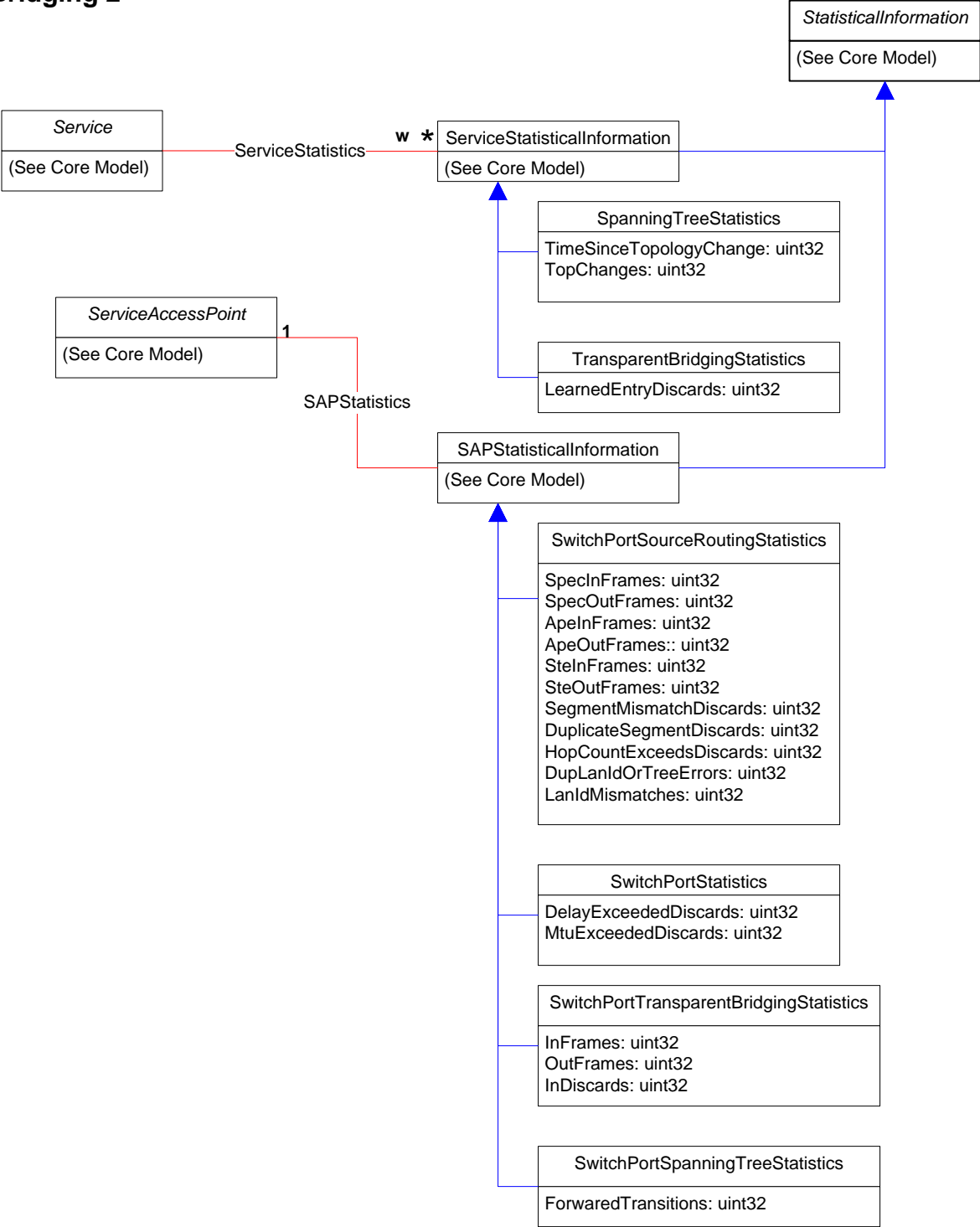







Page 19 of 45: QOS

-  Inheritance
-  Association
-  Association with WEAK reference
-  Aggregation
-  Aggregation with WEAK reference
-  Composition Aggregation
-  Equivalent to: 0..n

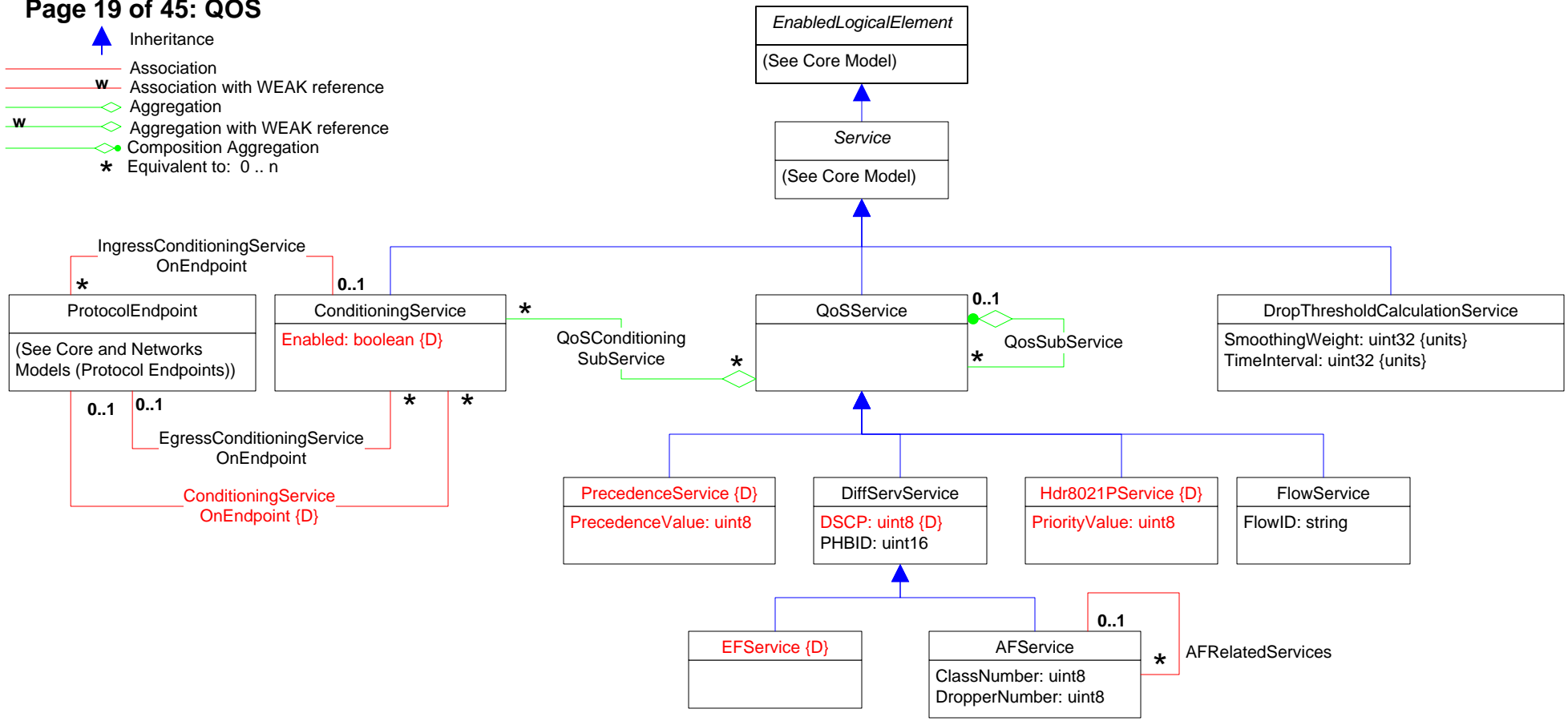

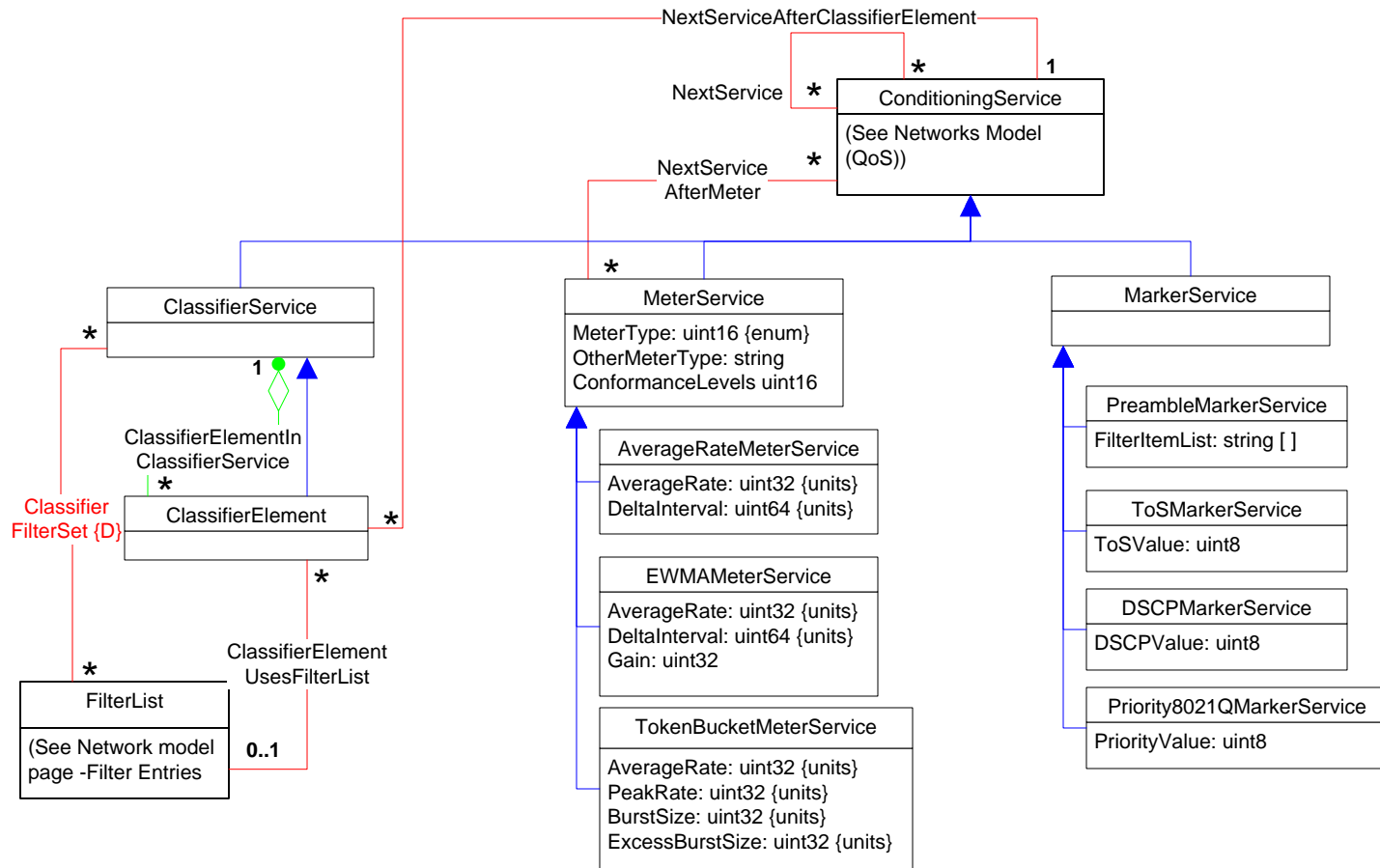
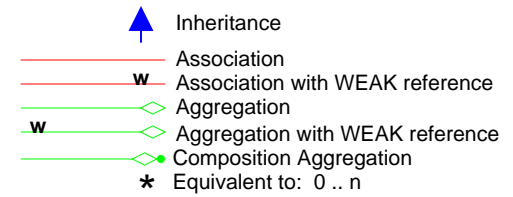

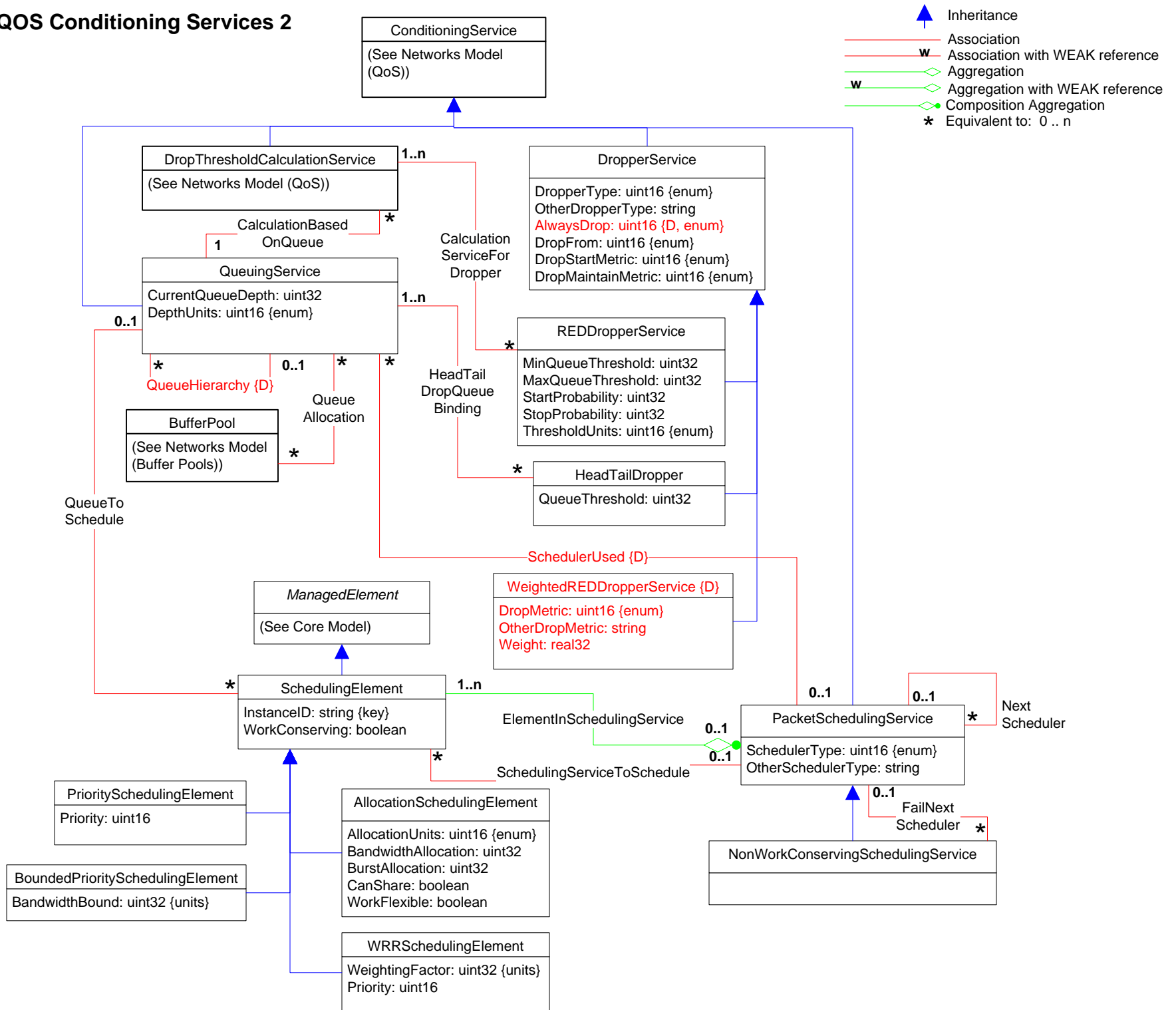

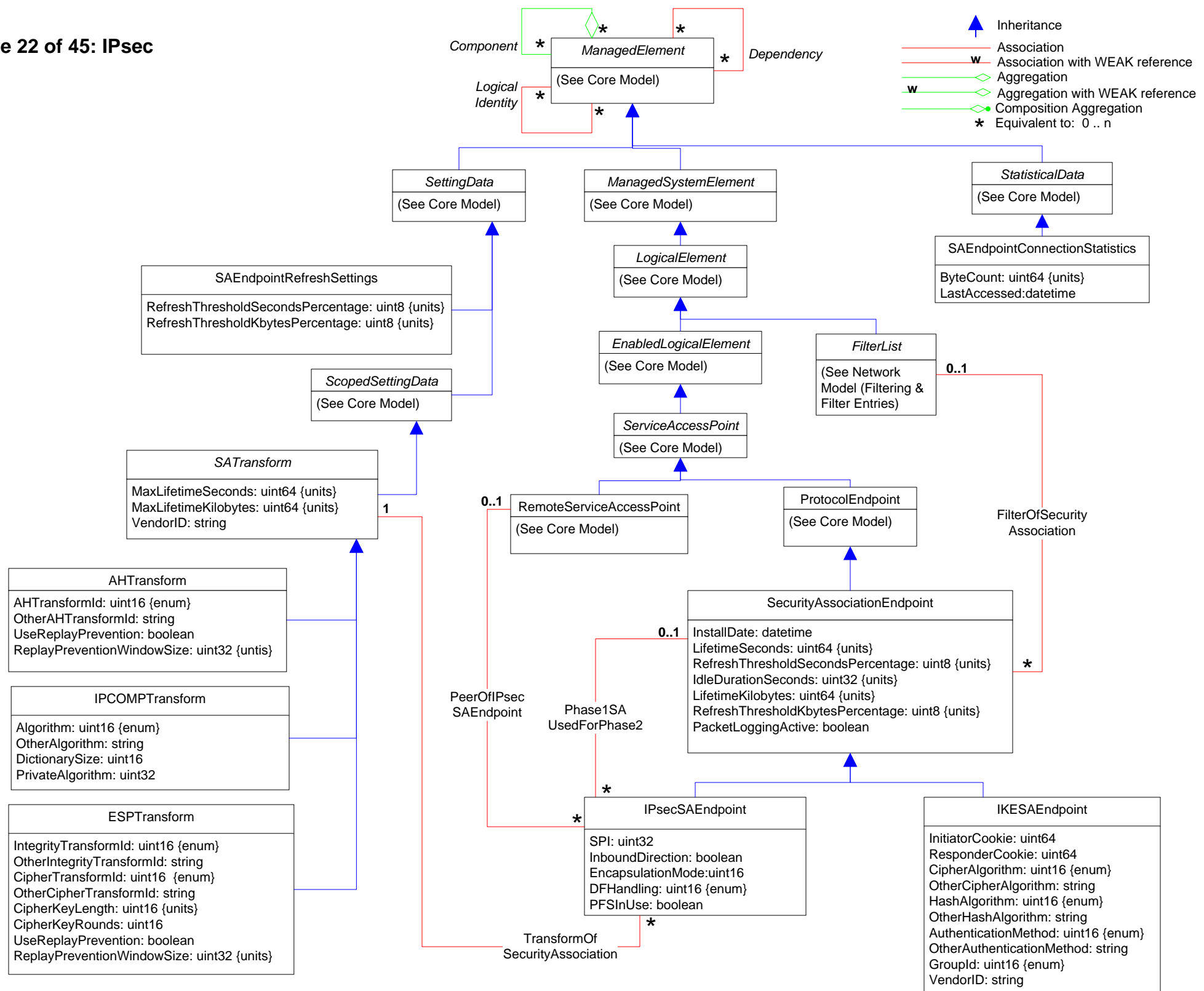

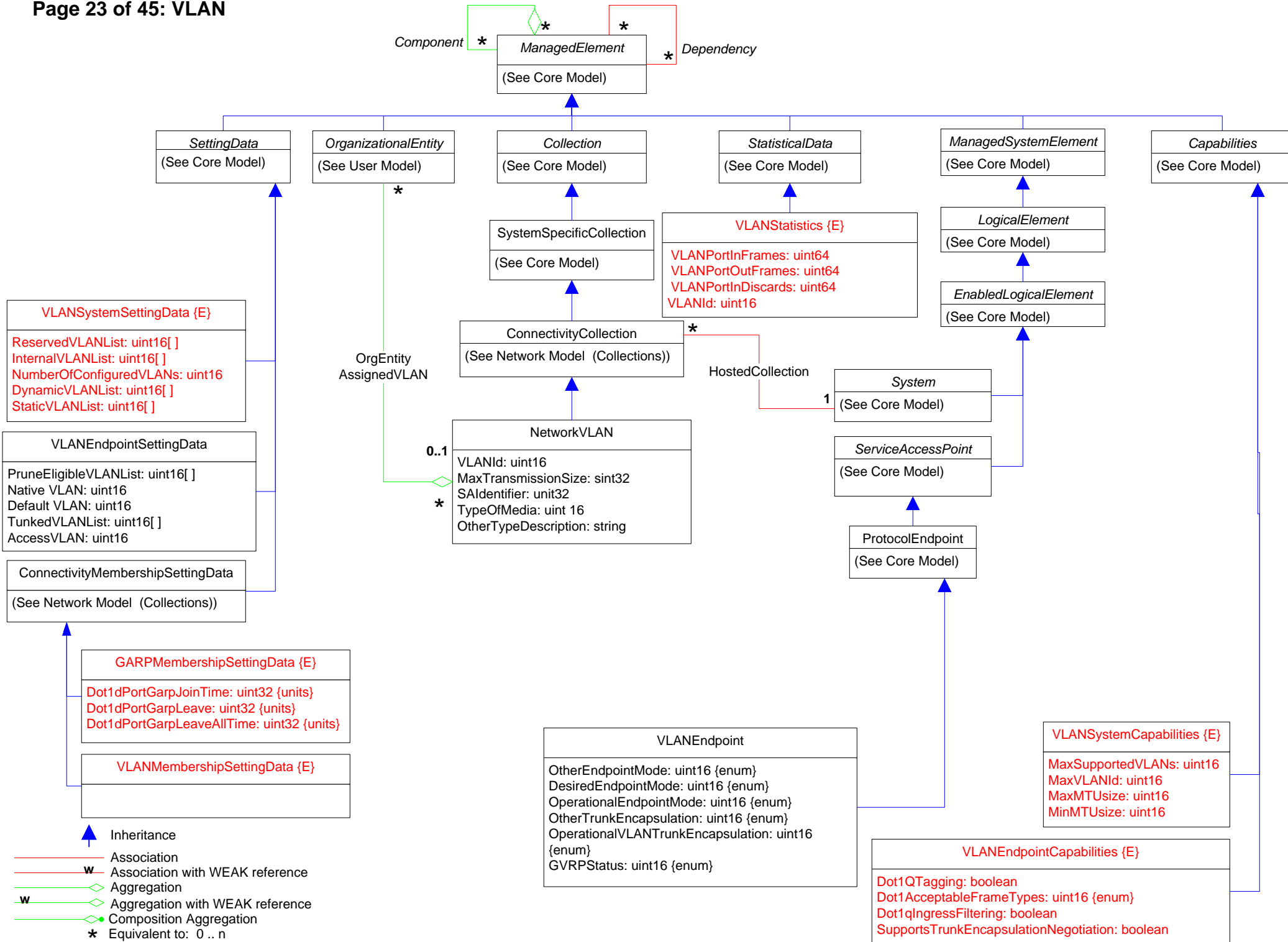



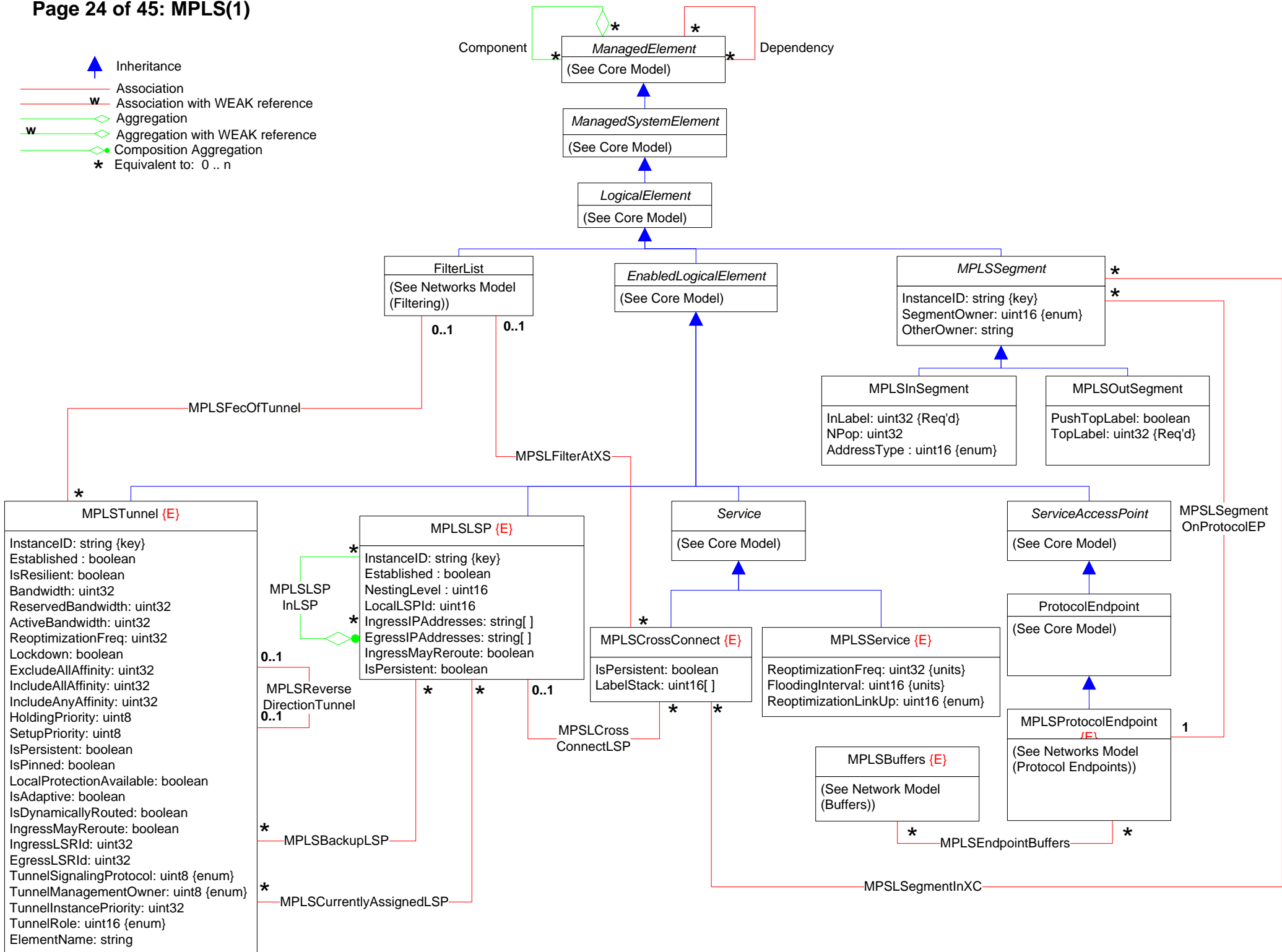

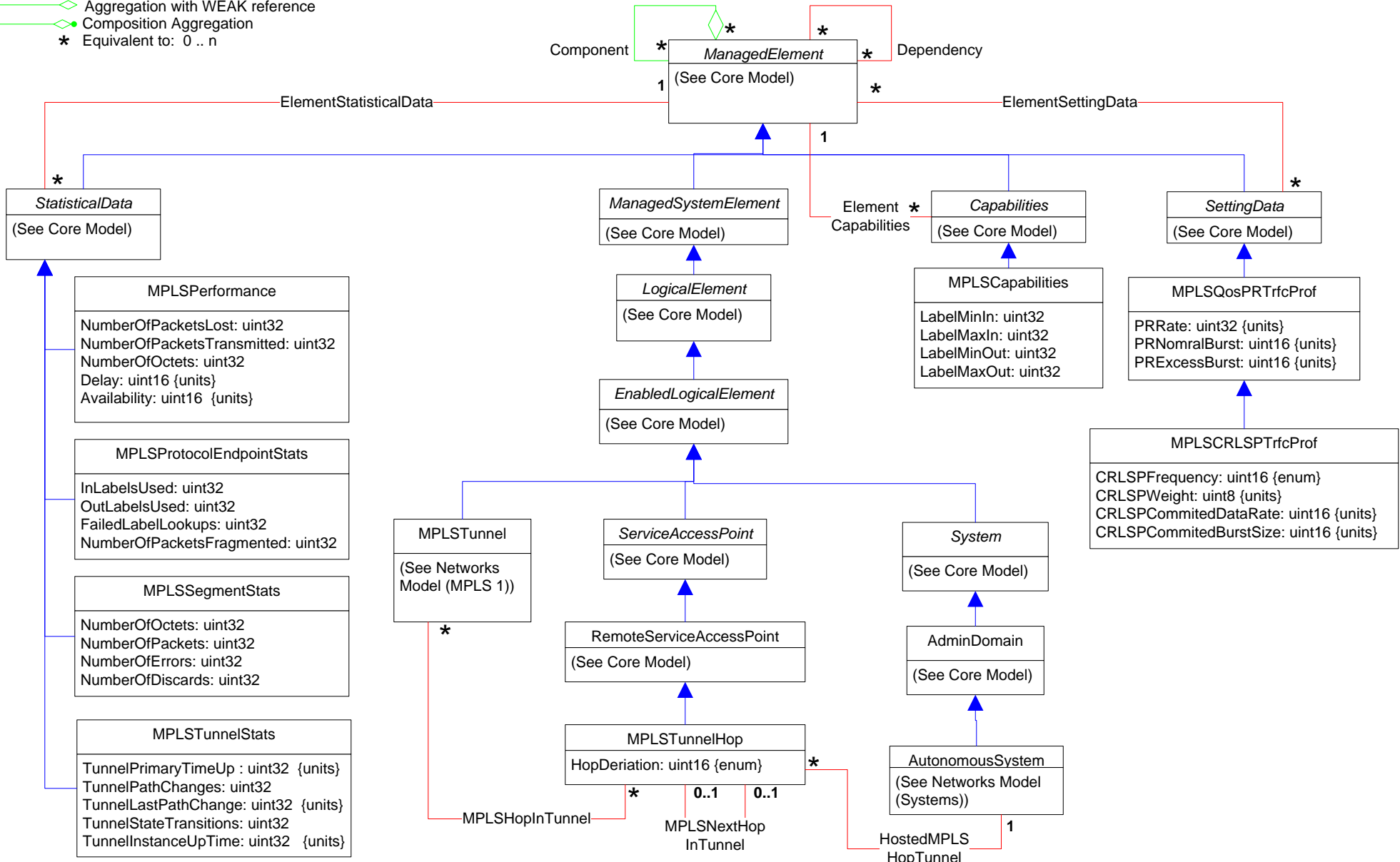
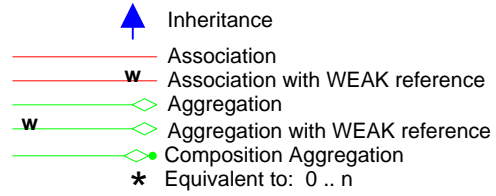



- Inheritance
- Association
- Association with WEAK reference
- Aggregation
- Aggregation with WEAK reference
- Composition Aggregation
- Equivalent to: 0 .. n







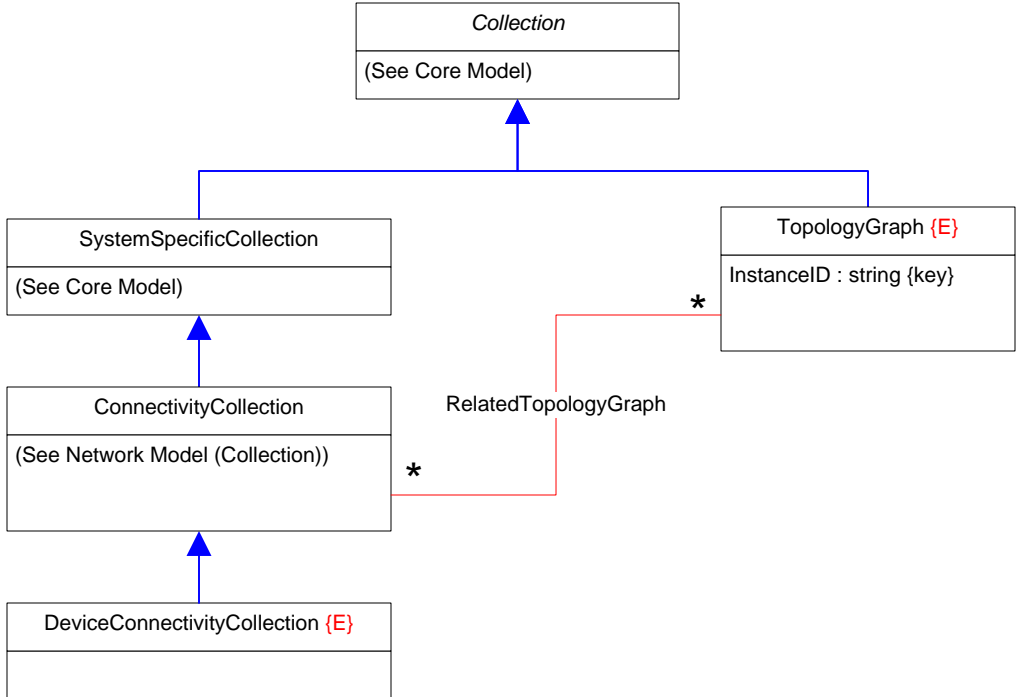

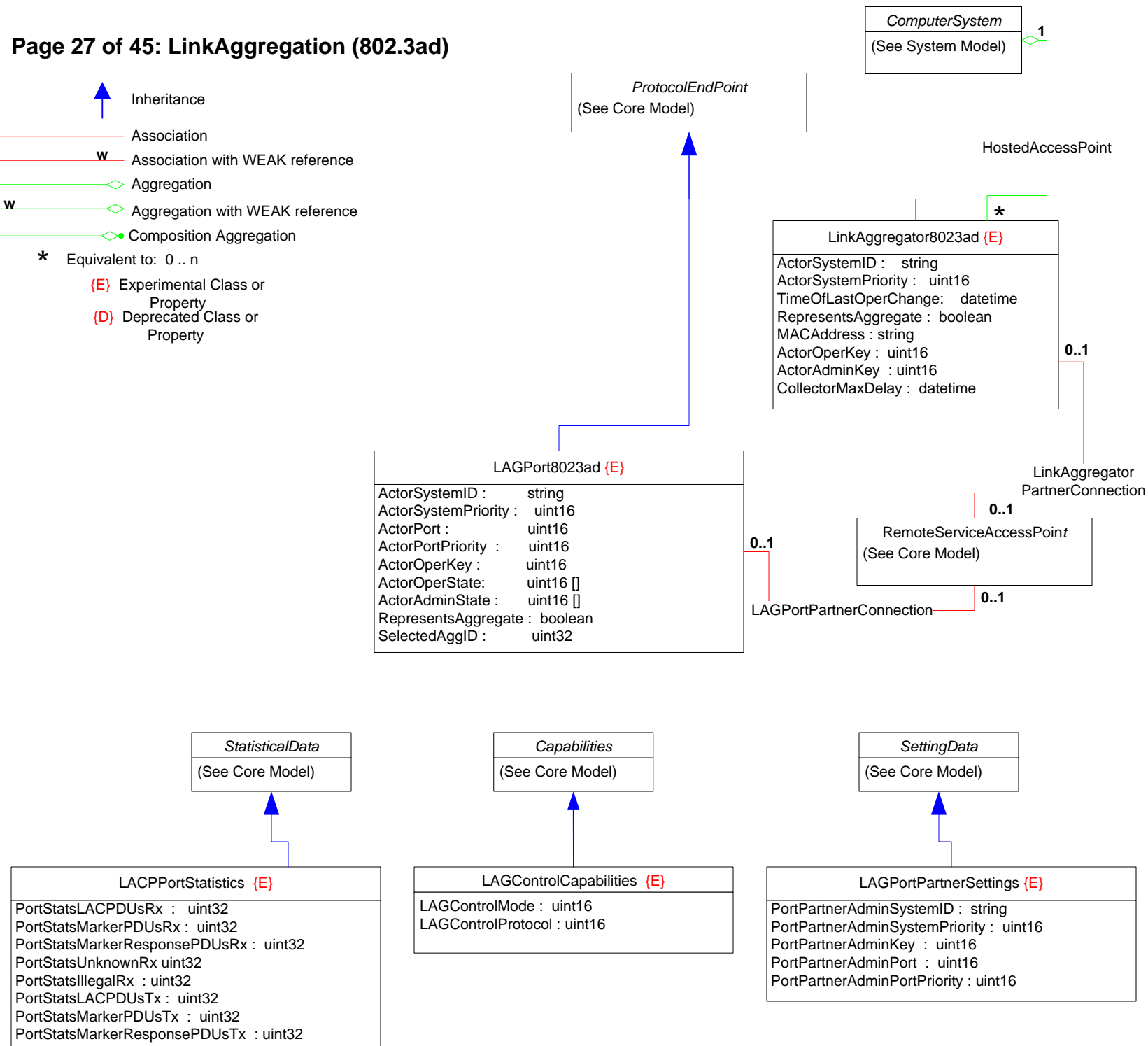
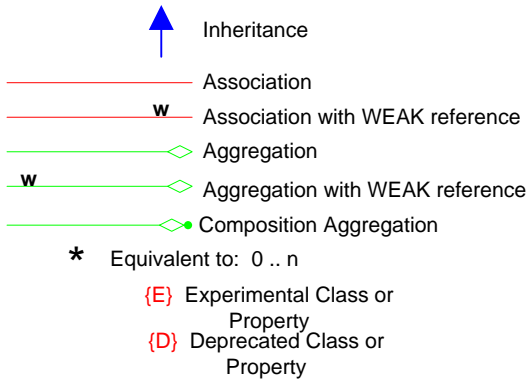

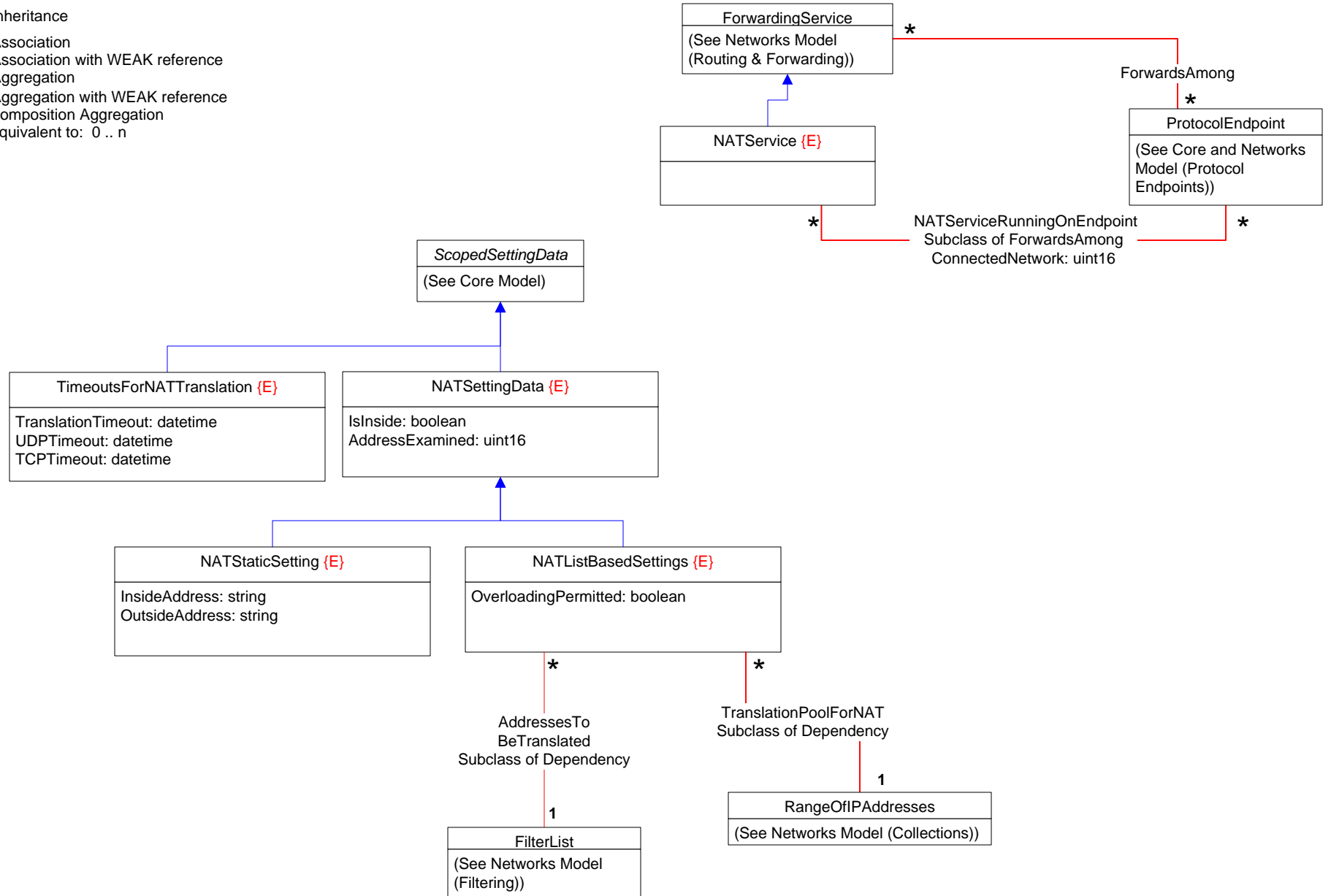
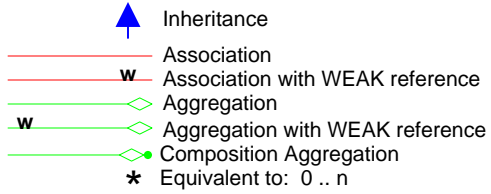

-  Inheritance
-  Association
-  Association with WEAK reference
-  Aggregation
-  Aggregation with WEAK reference
-  Composition Aggregation
-  Equivalent to: 0 .. n











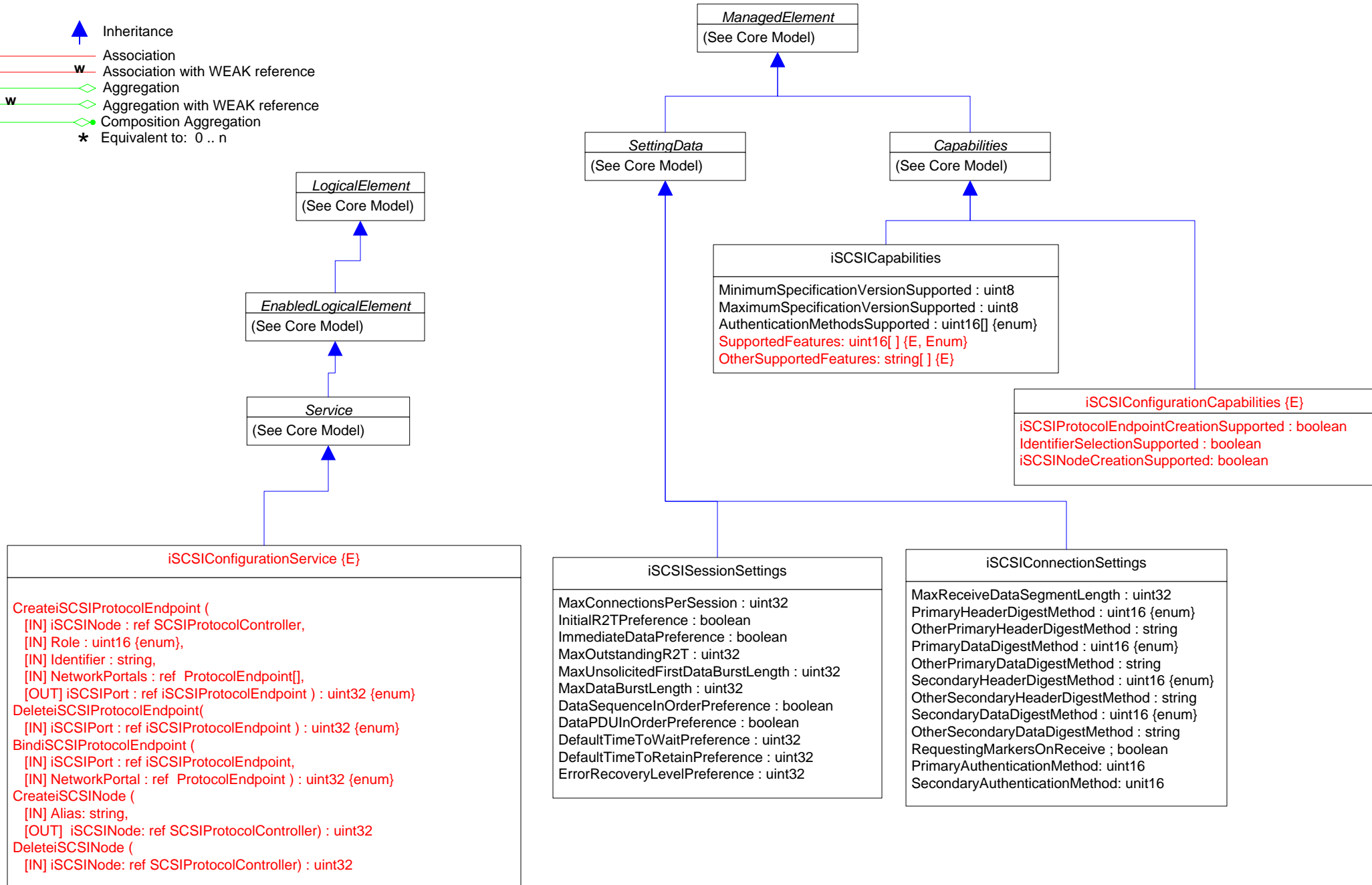

Page 25 : Network Address Translation (NAT)







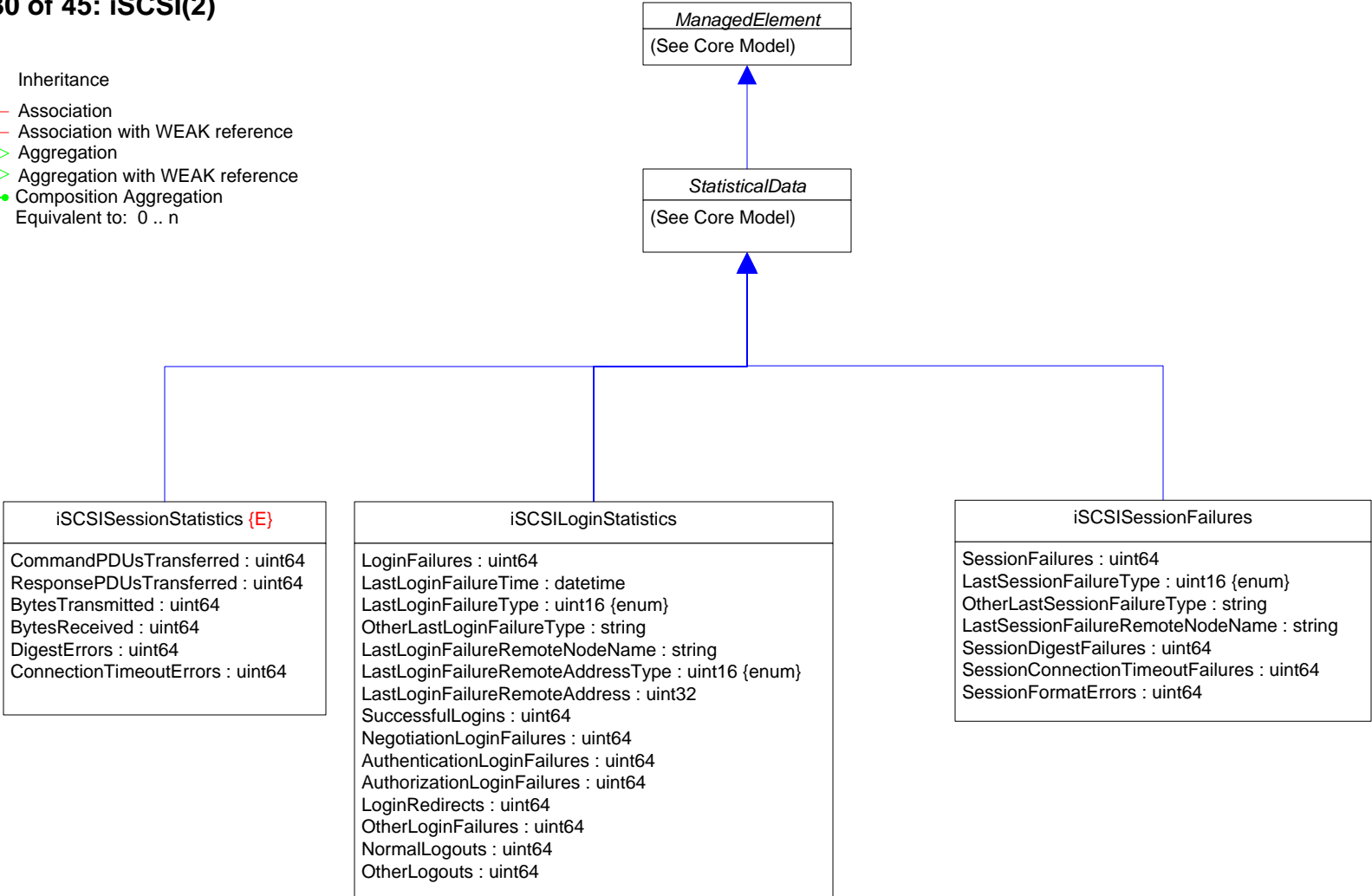

-  Inheritance
-  Association
-  Association with WEAK reference
-  Aggregation
-  Aggregation with WEAK reference
-  Composition Aggregation
-  Equivalent to: 0 .. n



-  Inheritance
-  Association
-  Association with WEAK reference
-  Aggregation
-  Aggregation with WEAK reference
-  Composition Aggregation
-  Equivalent to: 0 .. n





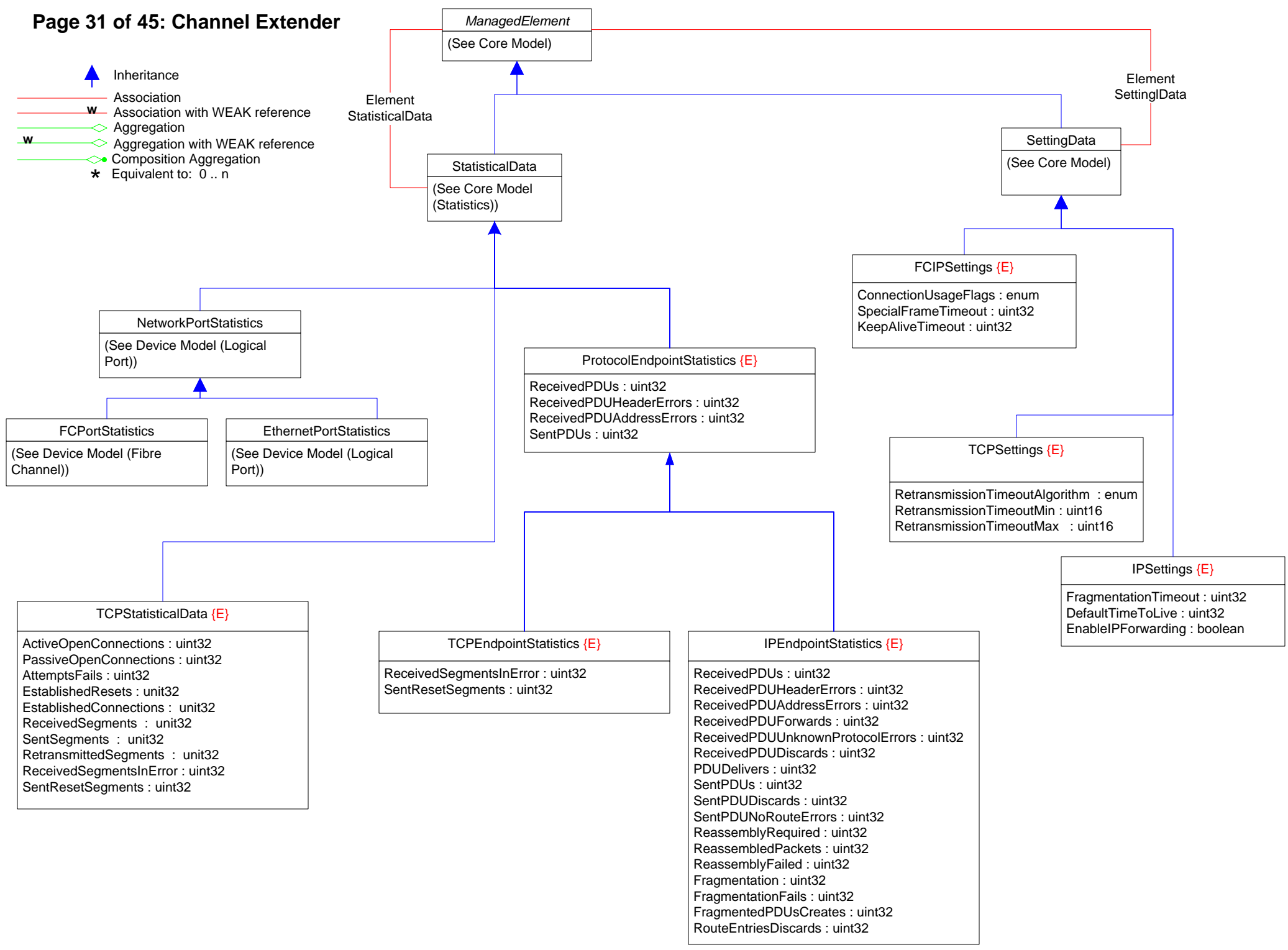

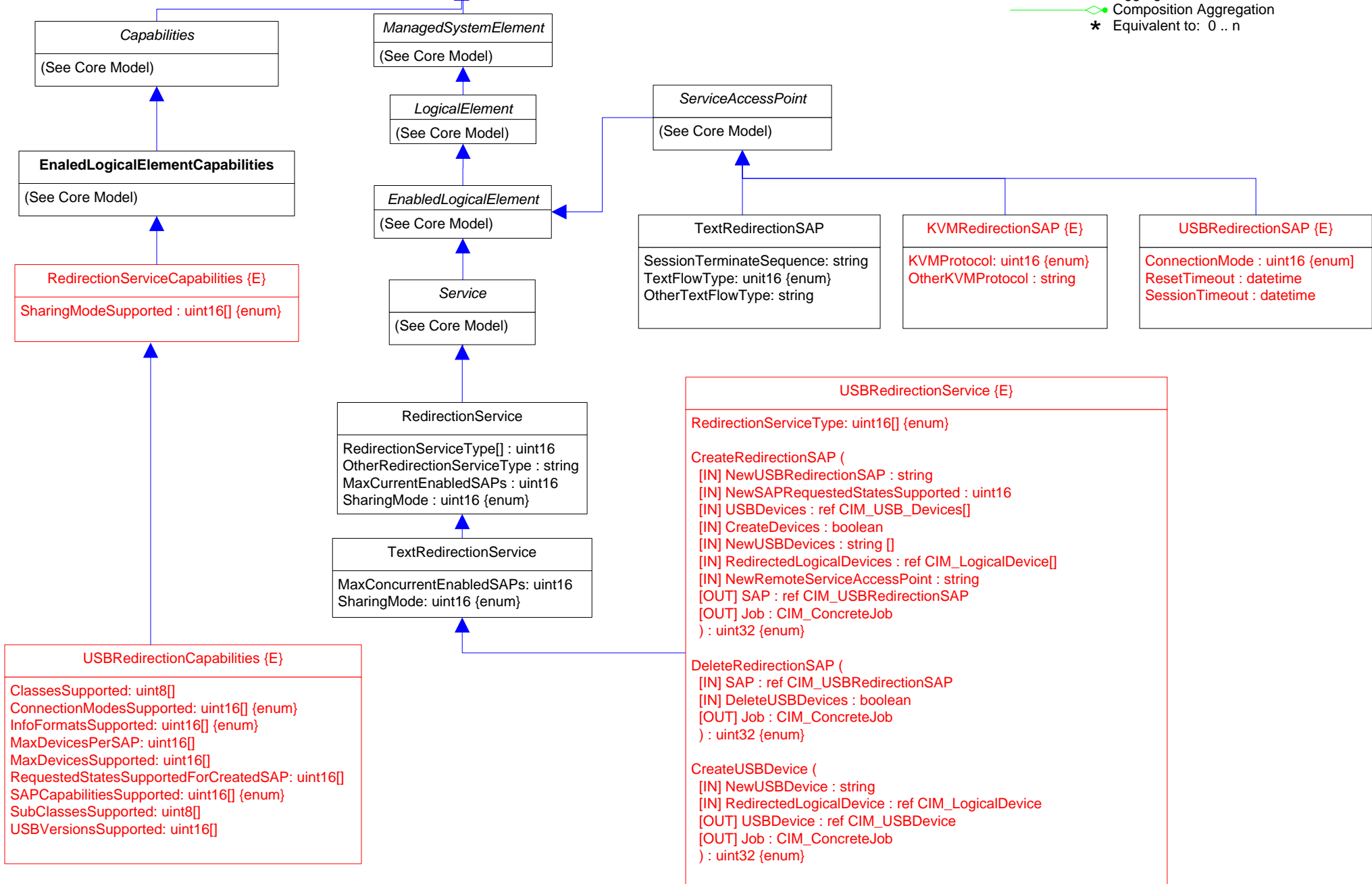
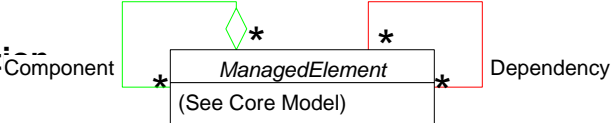

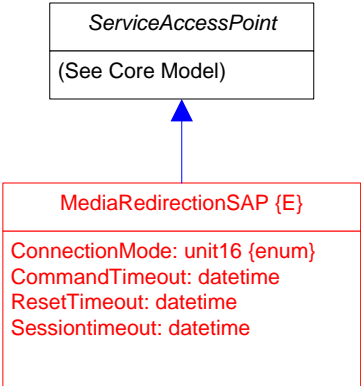
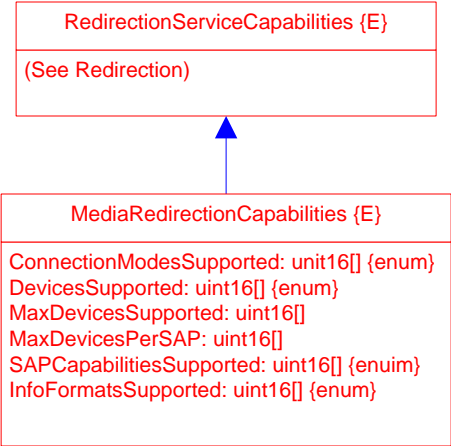
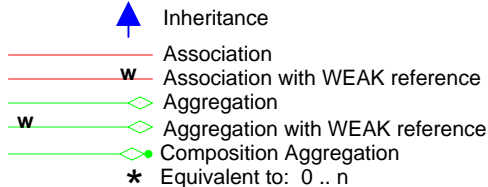
-  Inheritance
-  Association
-  Association with WEAK reference
-  Aggregation
-  Aggregation with WEAK reference
-  Composition Aggregation
-  Equivalent to: 0 .. n







-  Inheritance
-  Association
-  Association with WEAK reference
-  Aggregation
-  Aggregation with WEAK reference
-  Composition Aggregation
-  Equivalent to: 0 .. n

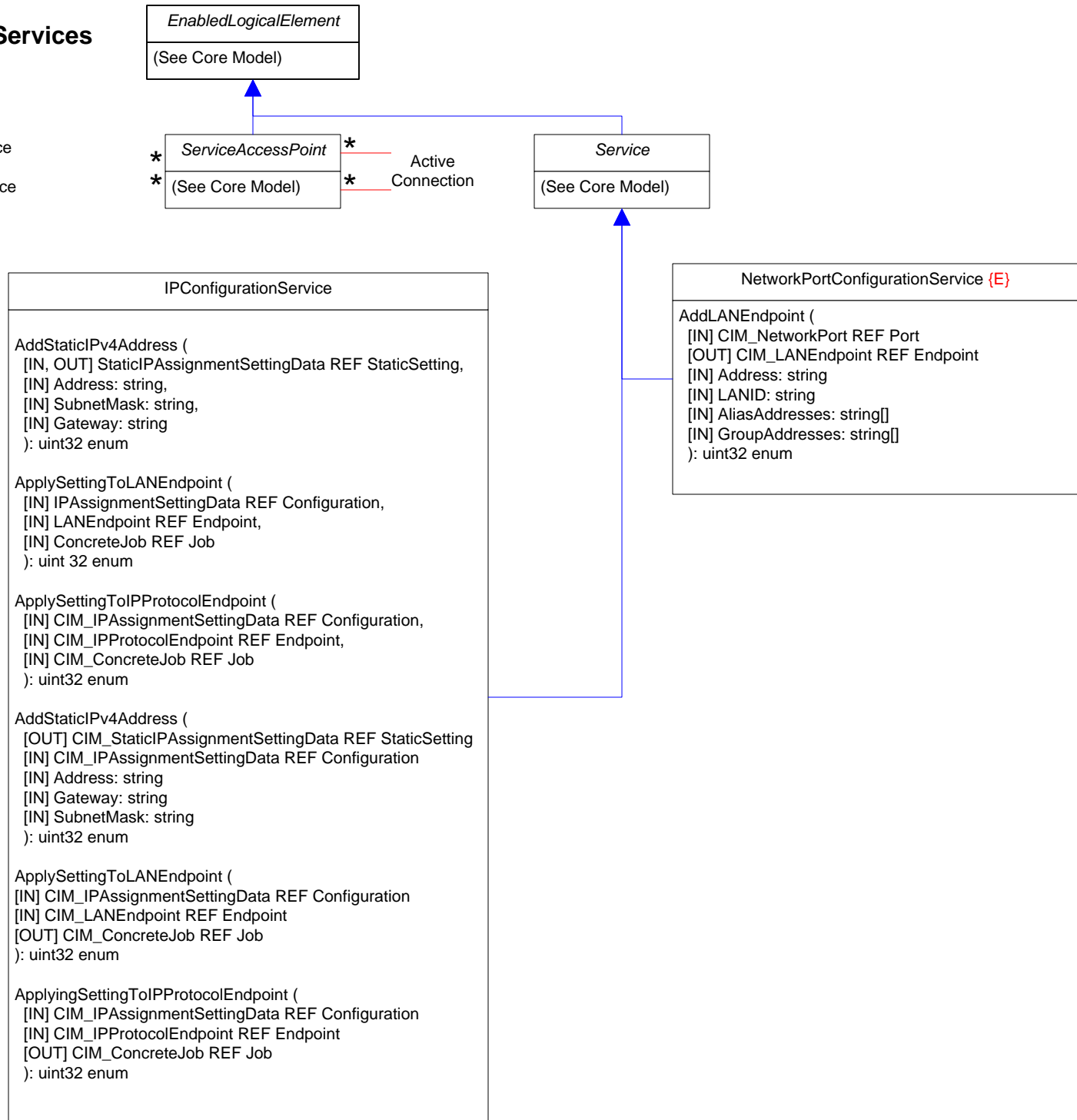

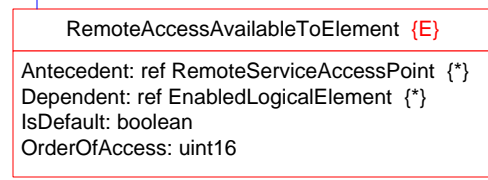
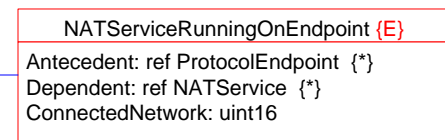
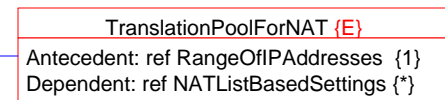
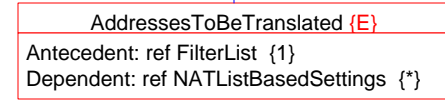
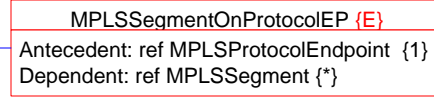
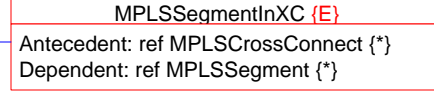
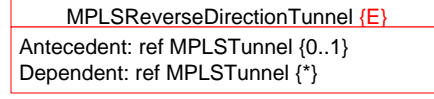
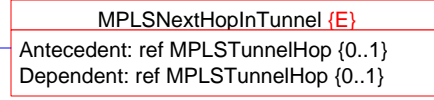
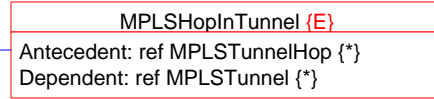
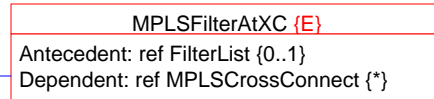
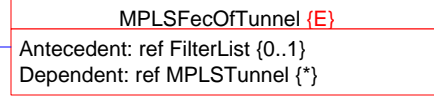
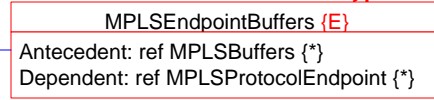
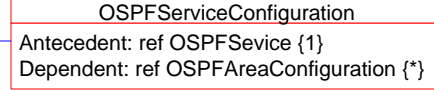
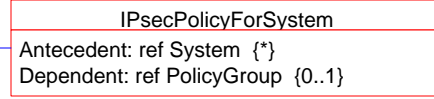
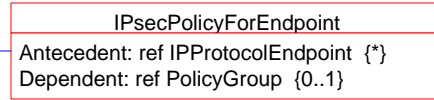
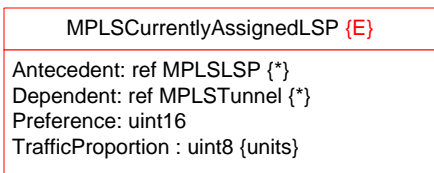
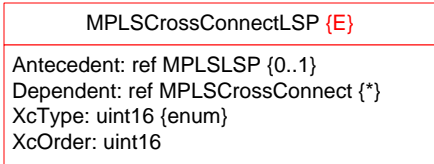
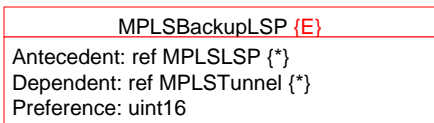
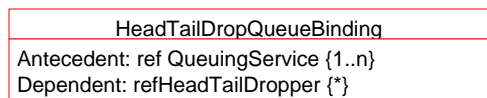
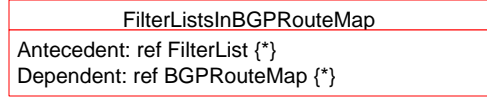
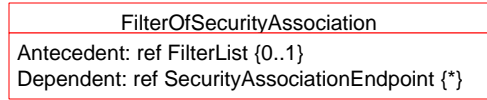
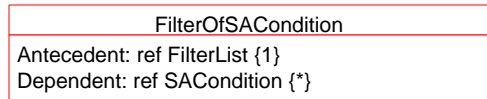
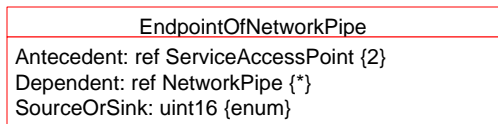
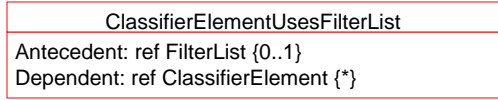
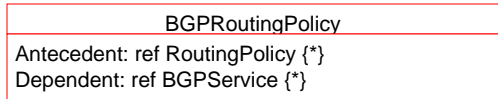
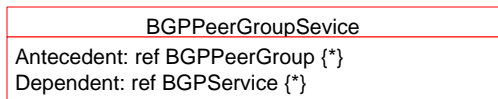
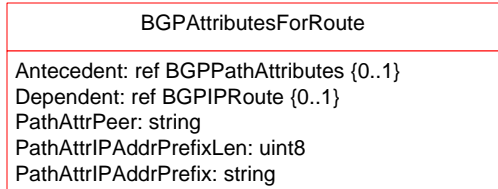
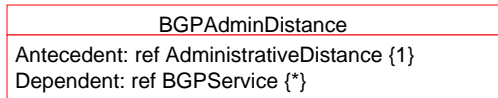
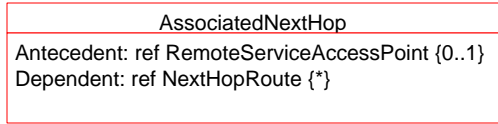
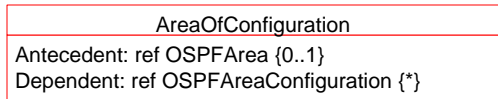
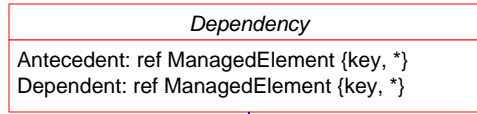

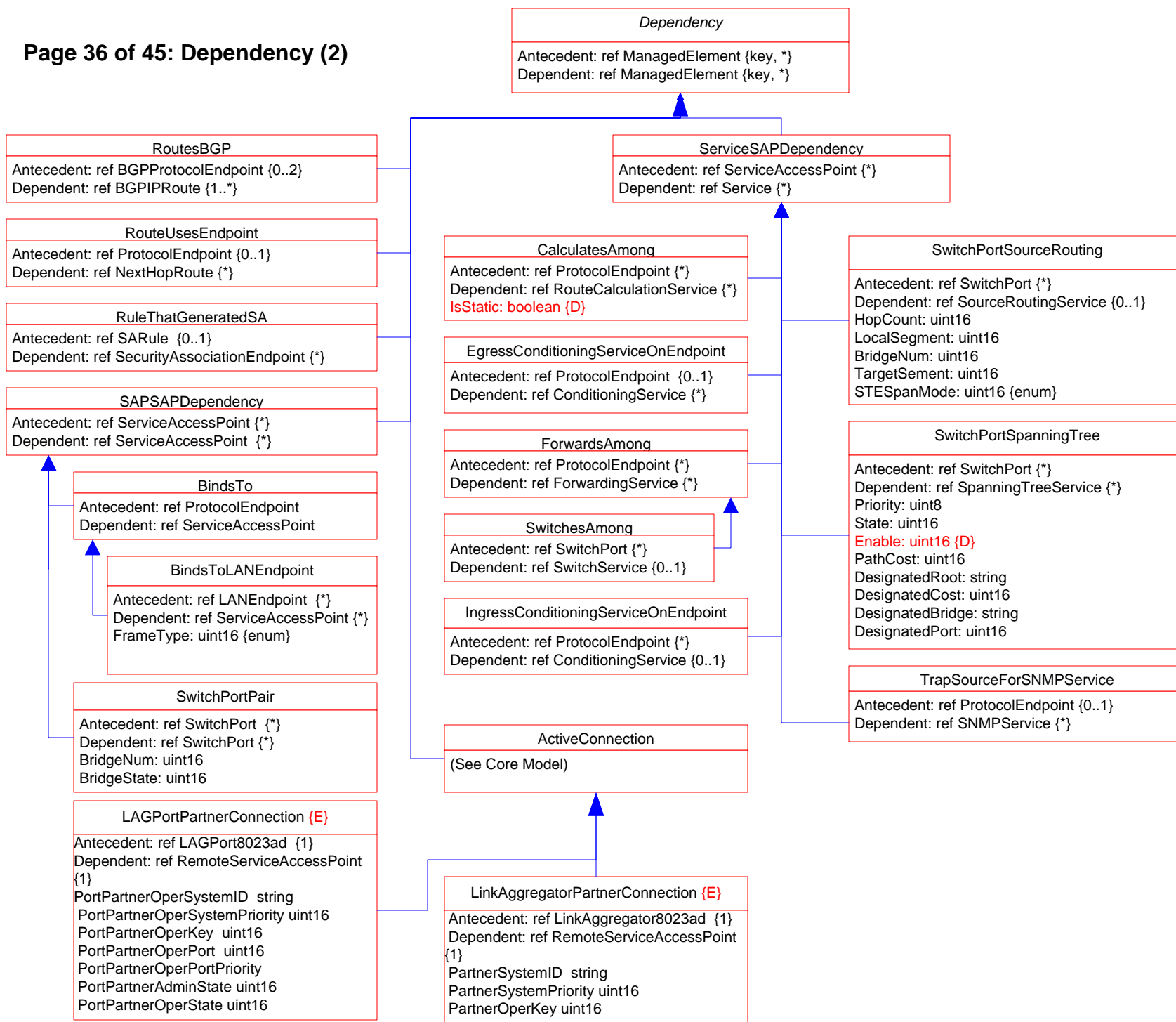

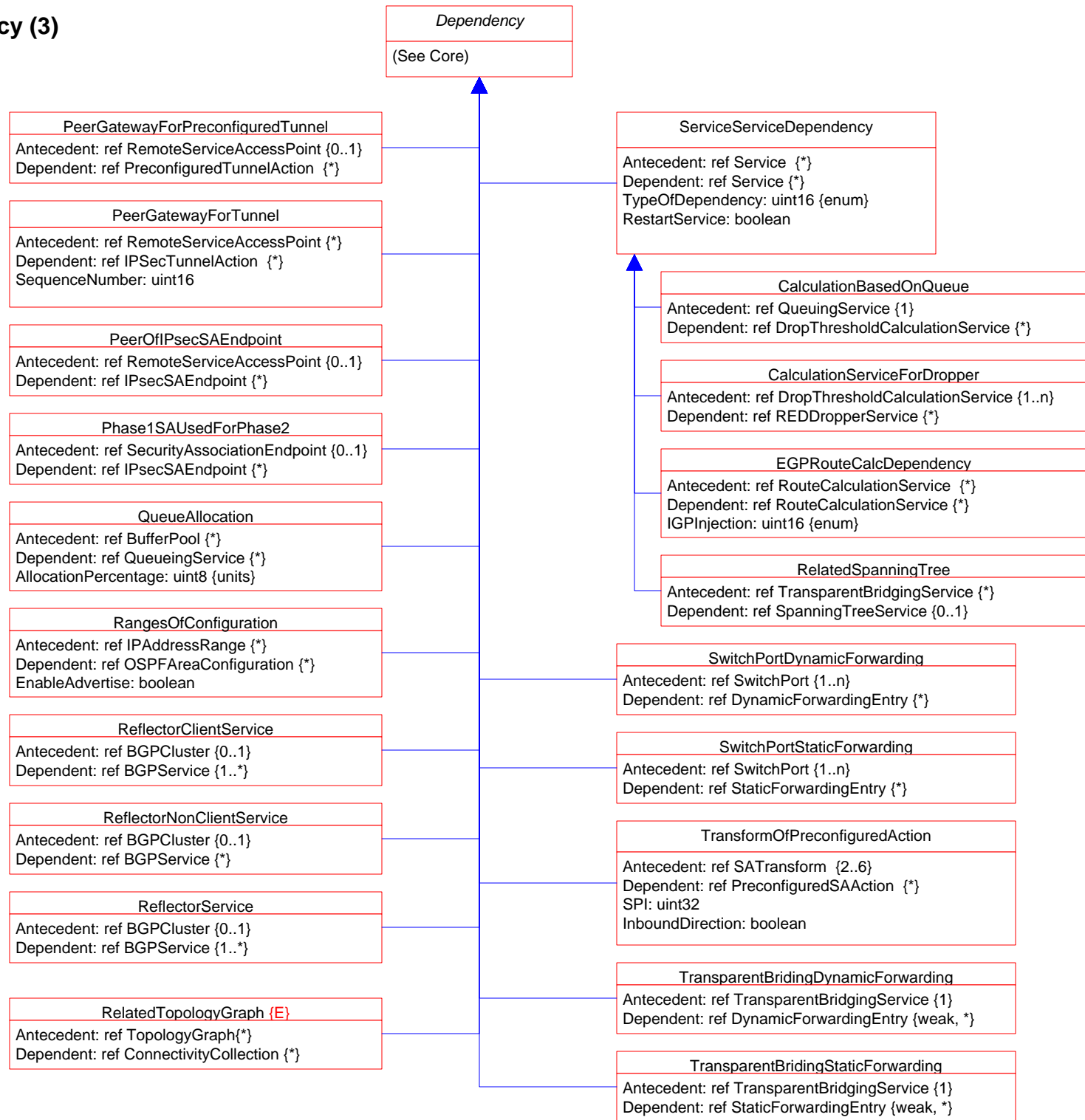

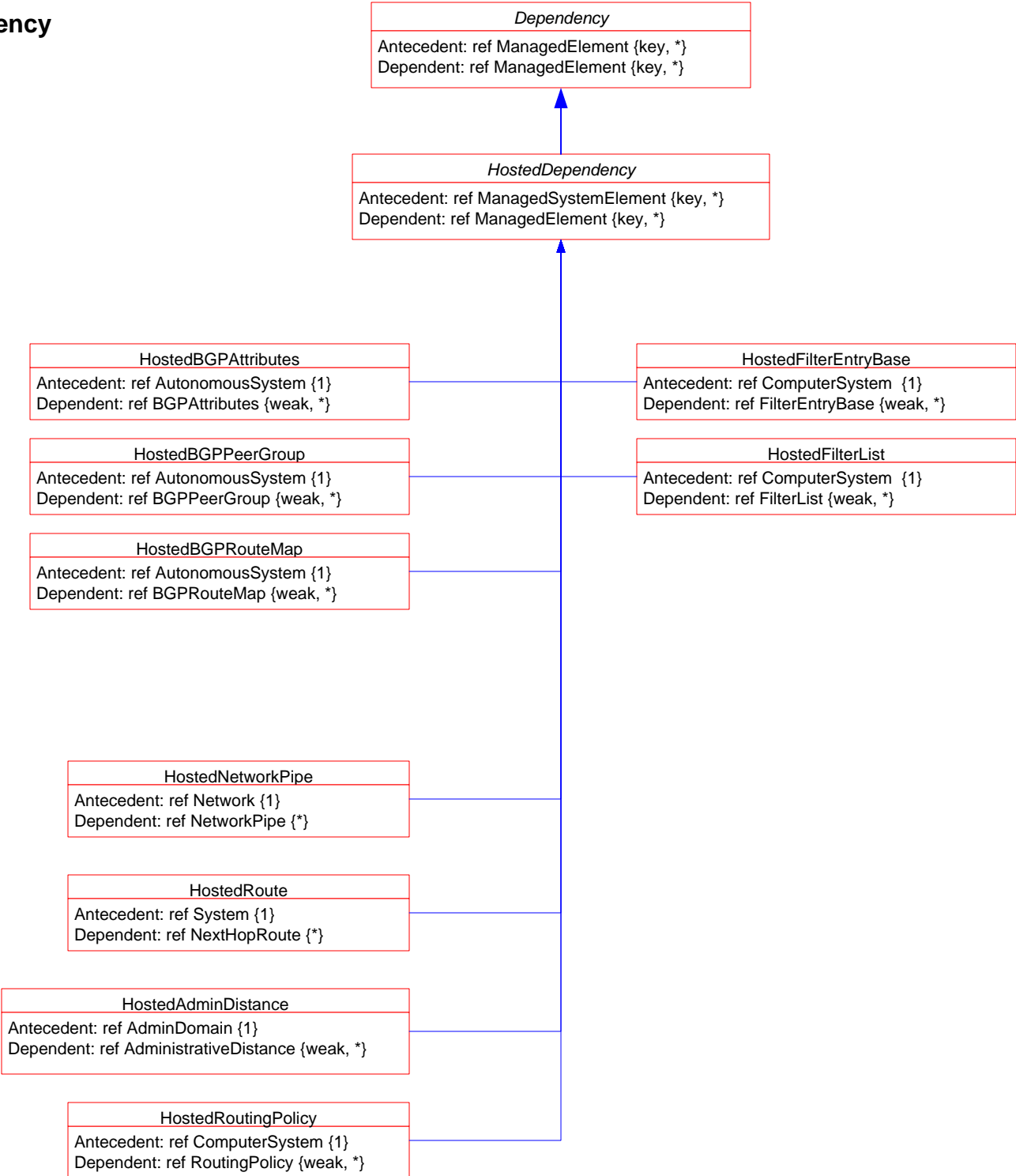

Page 39 of 45: Association Hierarchy

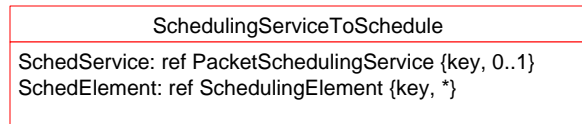
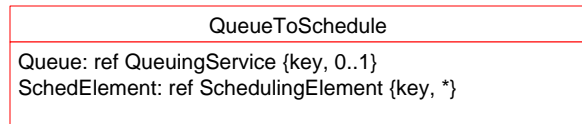
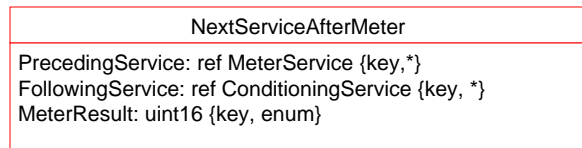
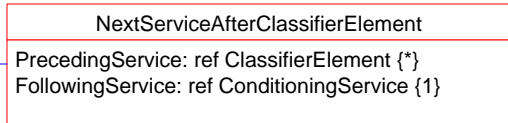
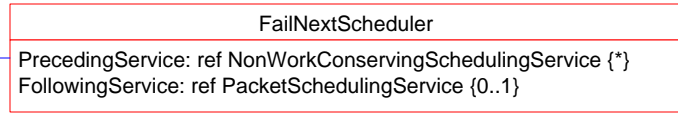
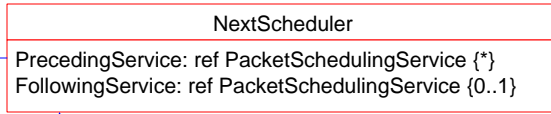
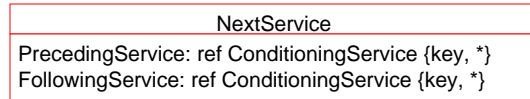
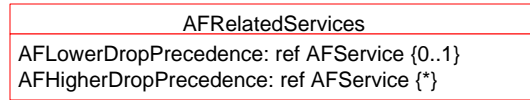
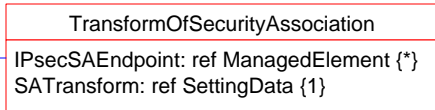
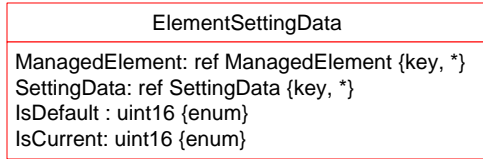
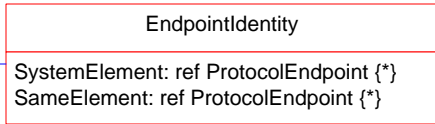
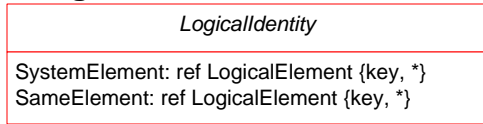

Page 40 of 45: Aggregation Hierarchy 1

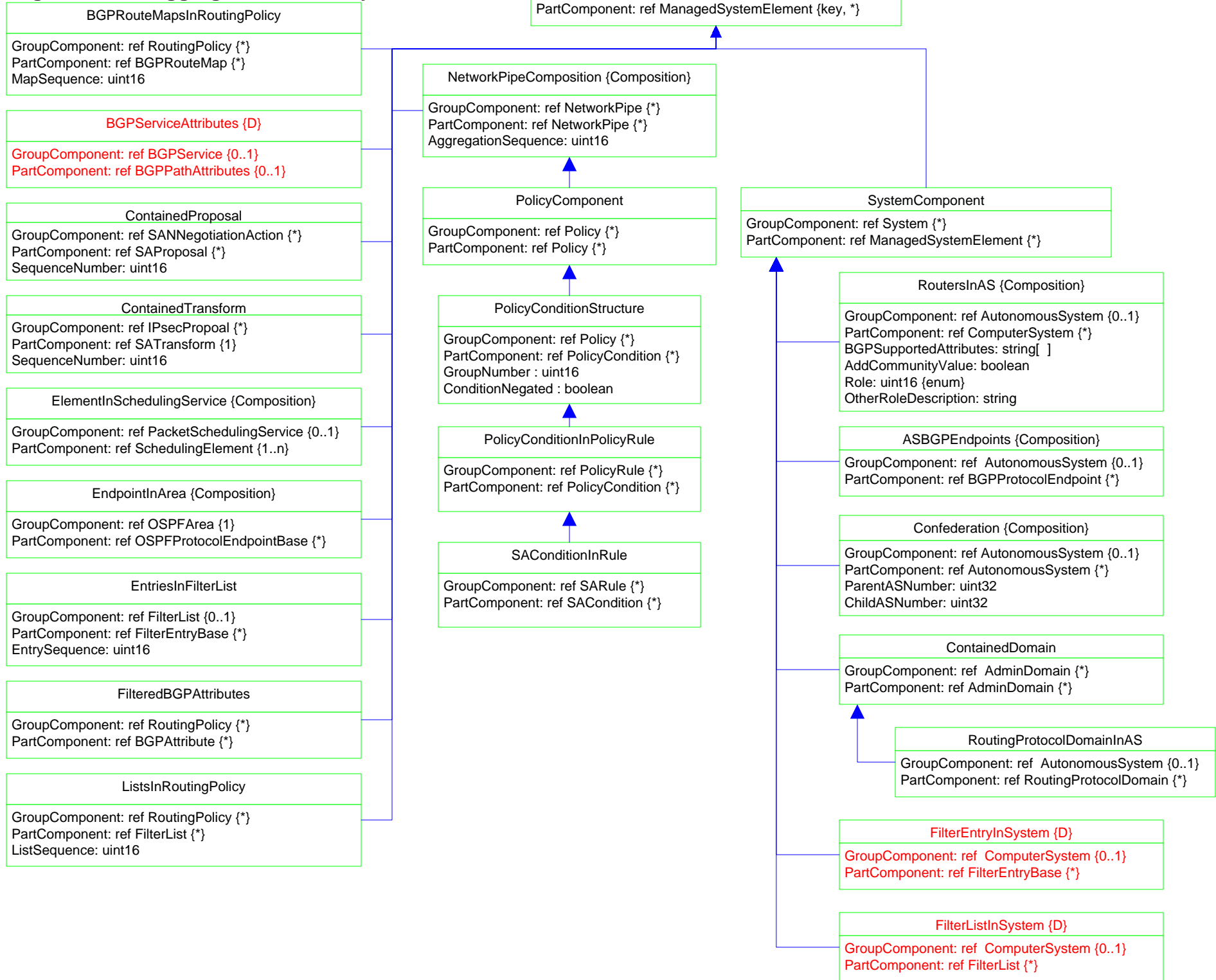

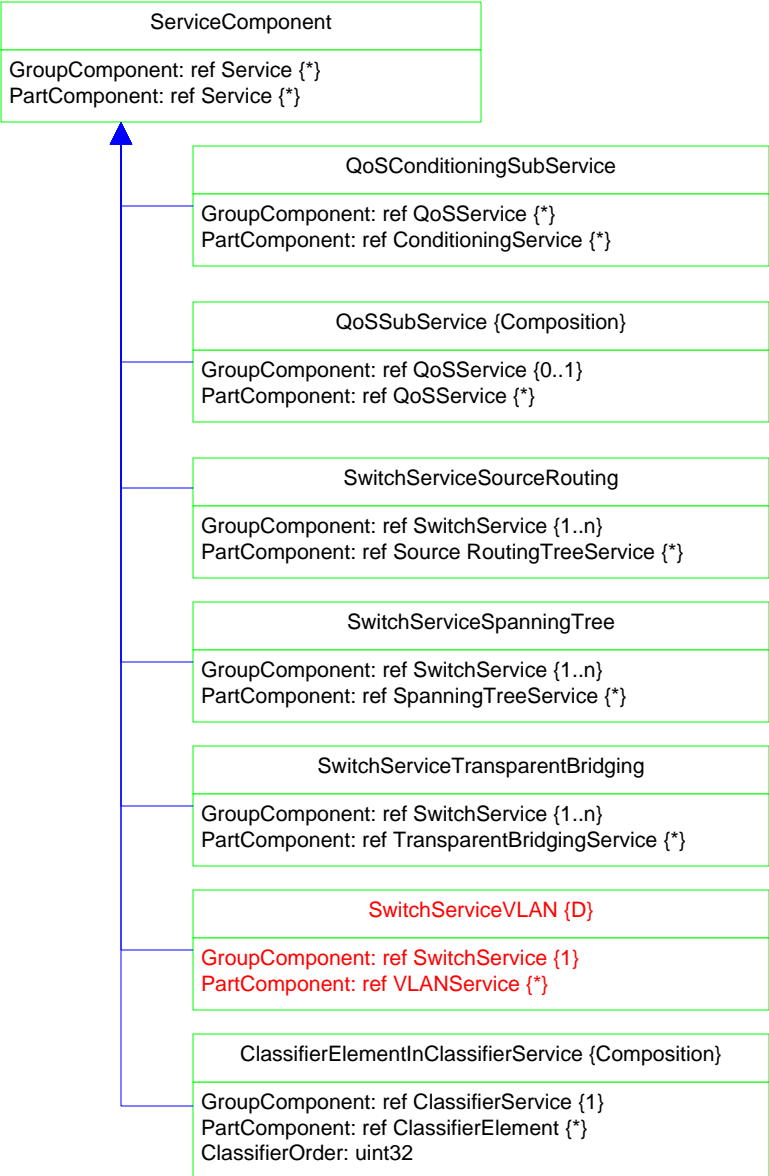





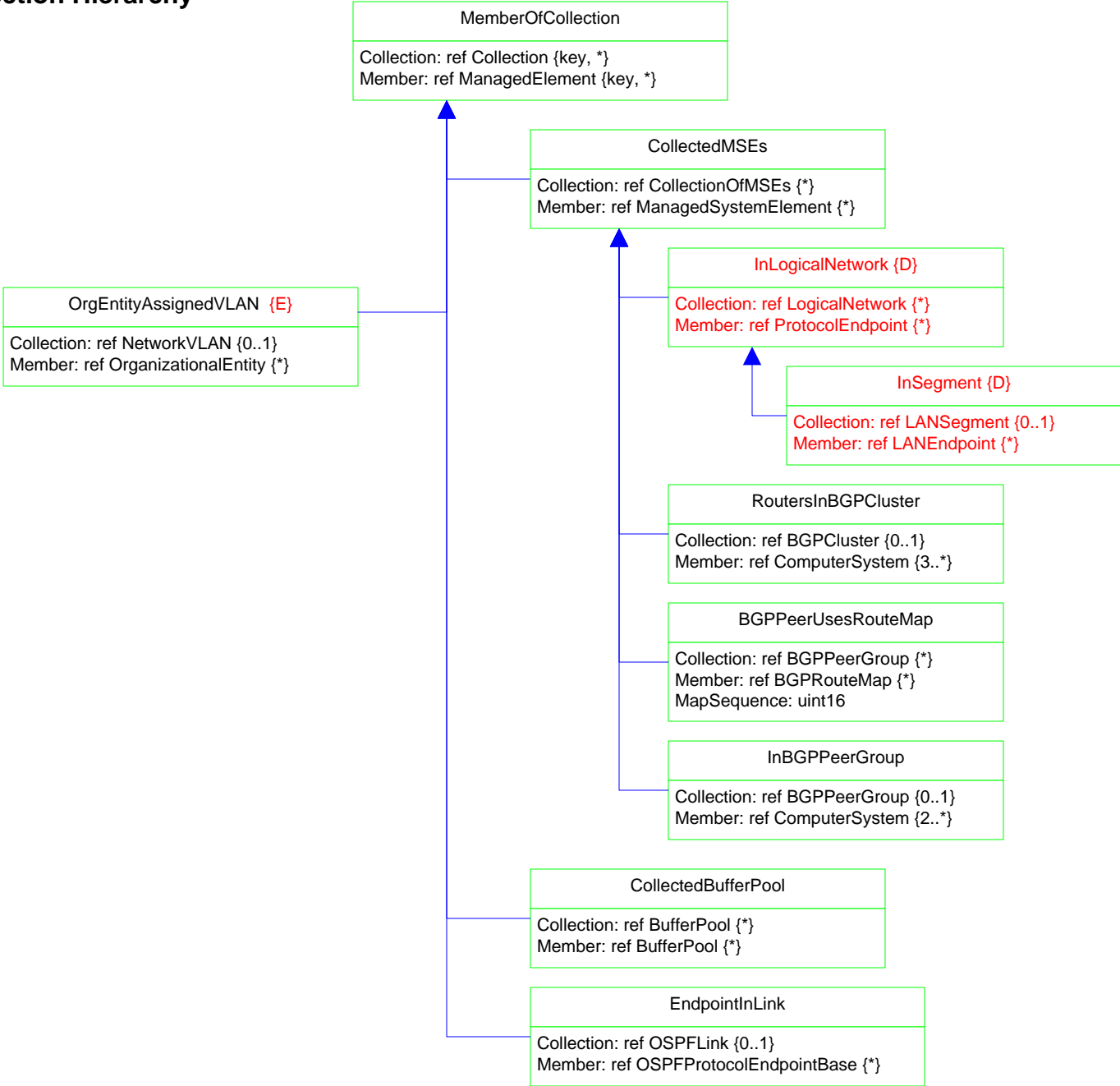

BGPClustersInAS {Composition}
GroupAS: ref AutonomousSystem {key, 0..1}
PartAS: ref BGPCluster {key, *}

Page 42 of 45: MemberOfCollection Hierarchy



Page 43 of 45: Deprecated VLAN

-  Inheritance
-  Association
-  Association with WEAK reference
-  Aggregation
-  Aggregation with WEAK reference
-  Composition Aggregation
-  Equivalent to: 0 .. n

