

Title : System Specification V2.18  
 Filename : CIM\_System.vsd  
 Author : DMTF Core Schema WG  
 Date : 21 April 2008

Page 1 : Overview  
 Page 2 : Computer System  
 Page 3 : Local File Systems  
 Page 4 : Remote FS/File Export  
 Page 5 : File Import  
 Page 6 : FileSystemService  
 Page 7 : Operating System  
 Page 8 : Processing and Job Queues  
 Page 9 : Jobs 2  
 Page 10 : Boot Service  
 Page 11 : Time  
 Page 12 : UNIX  
 Page 13 : System Resources  
 Page 14 : Message Logs  
 Page 15 : Logs 2  
 Page 16 : Diagnostics 1  
 Page 17 : Diagnostics 2  
 Page 18 : Help  
 Page 19 : Virtualization  
 Page 20 : Virtualization 2  
 Page 21 - Watchdog

Page 22 : Bios  
 Page 22 : Association Hierarchy  
 Page 23 : Dependency Hierarchy  
 Page 24 : Dependency Hierarchy (2)  
 Page 25 : Aggregation Hierarchy

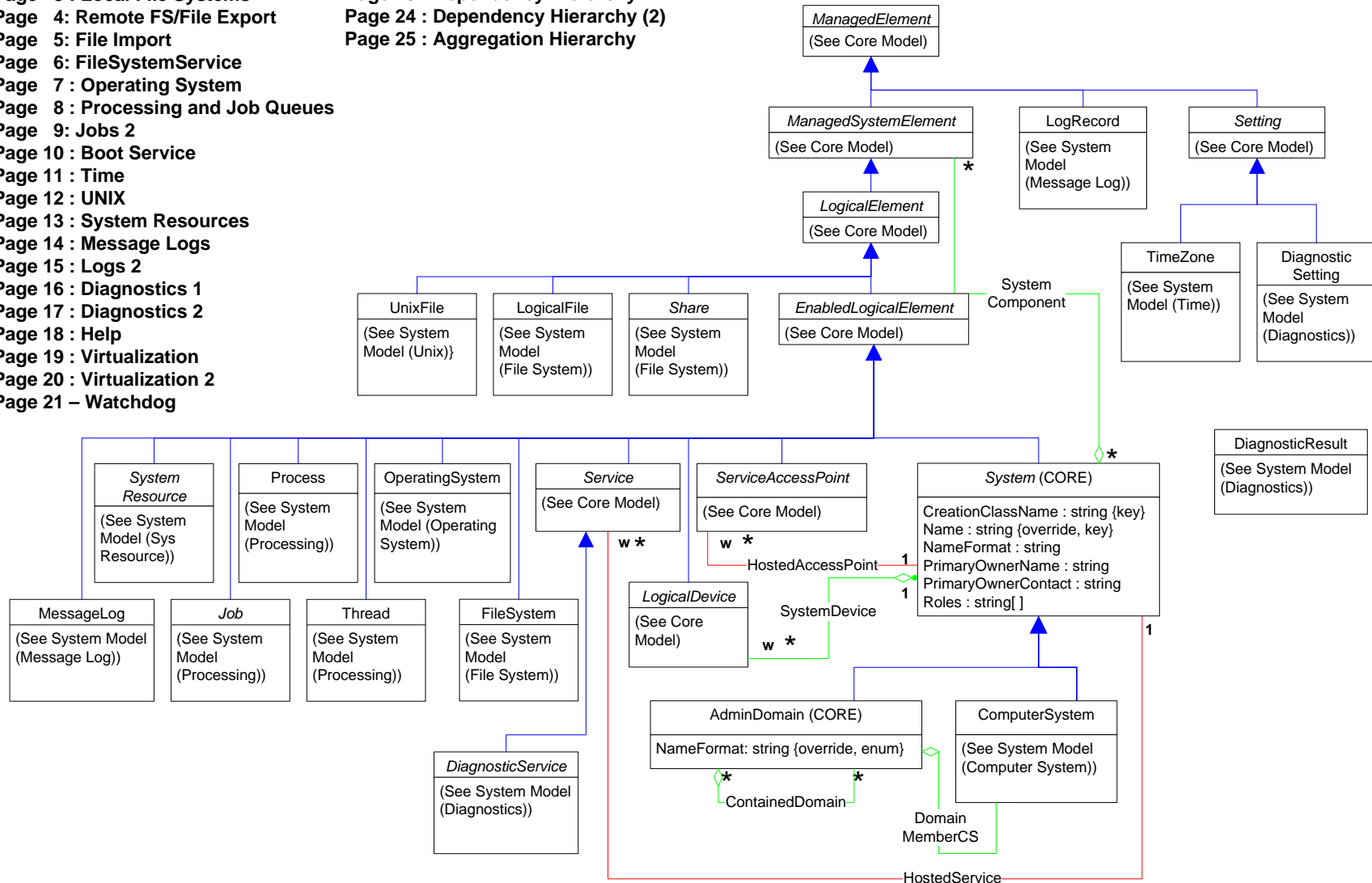
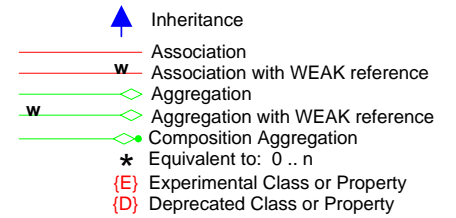

Page 2 : ComputerSystem

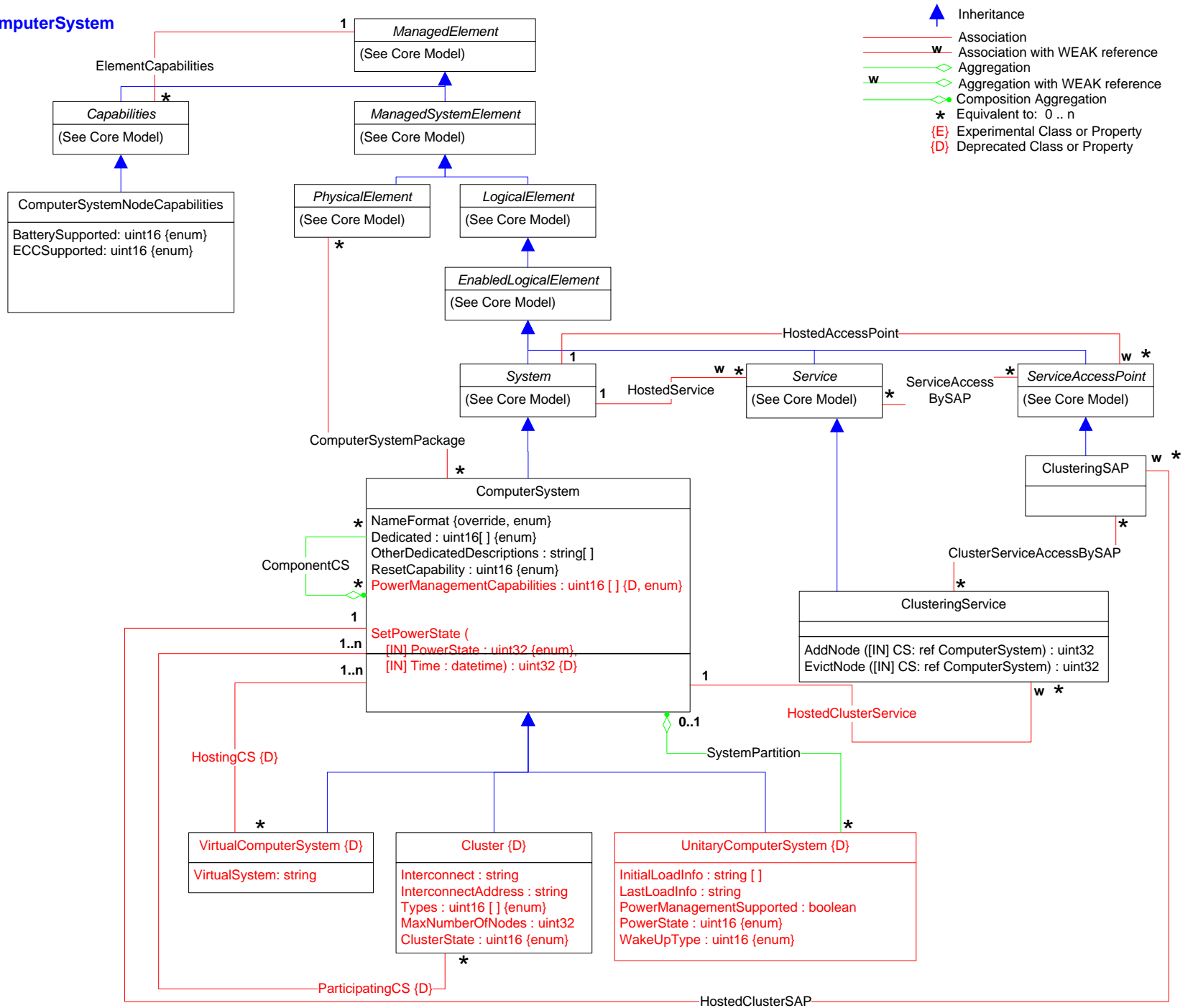

### Page 3 : Local File Systems

- ▲ Inheritance
- Association
- w Association with WEAK reference
- ◇ Aggregation
- w◇ Aggregation with WEAK reference
- ◊ Composition Aggregation
- \* Equivalent to: 0 .. n
- {E} Experimental Class or Property
- {D} Deprecated Class or Property

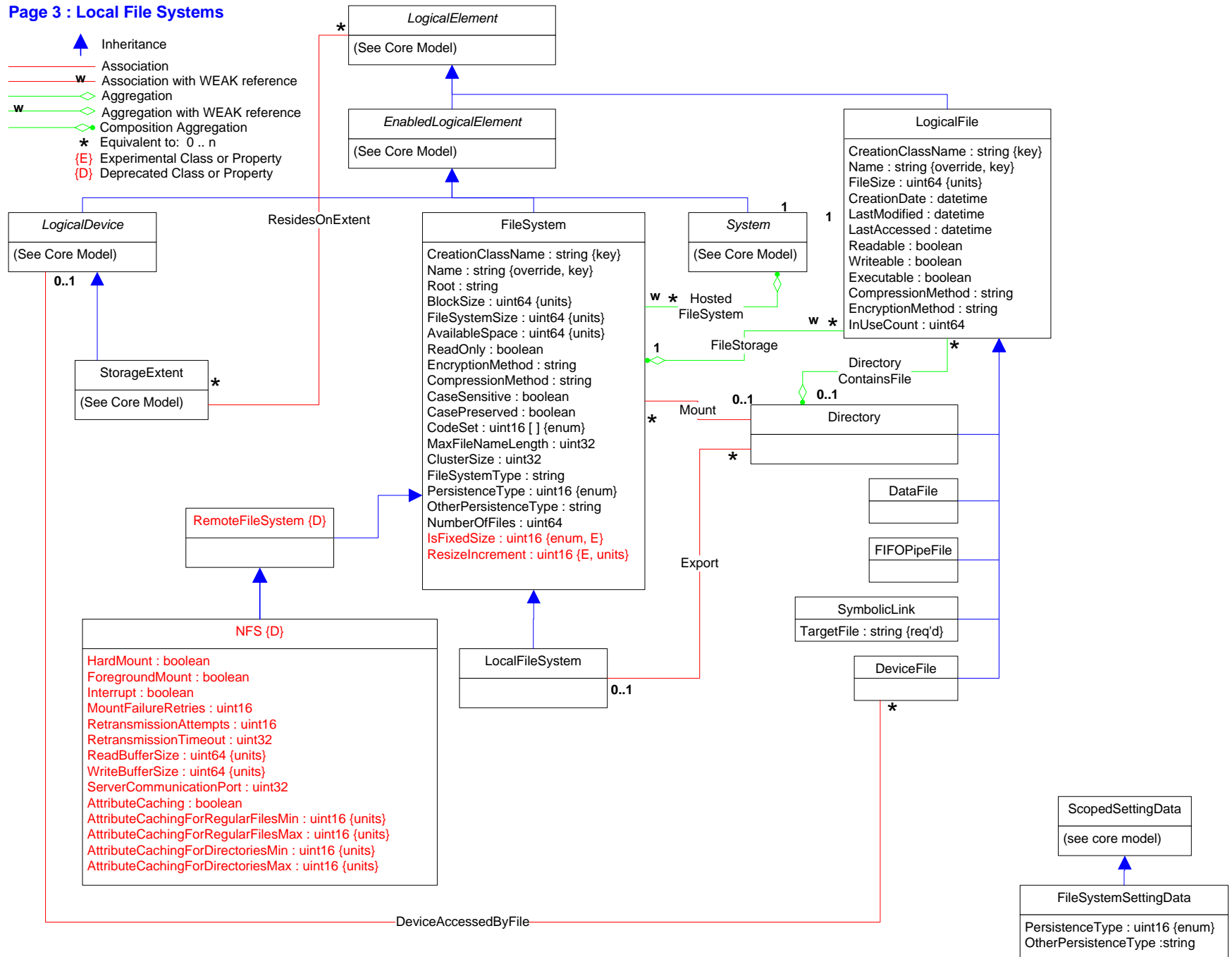





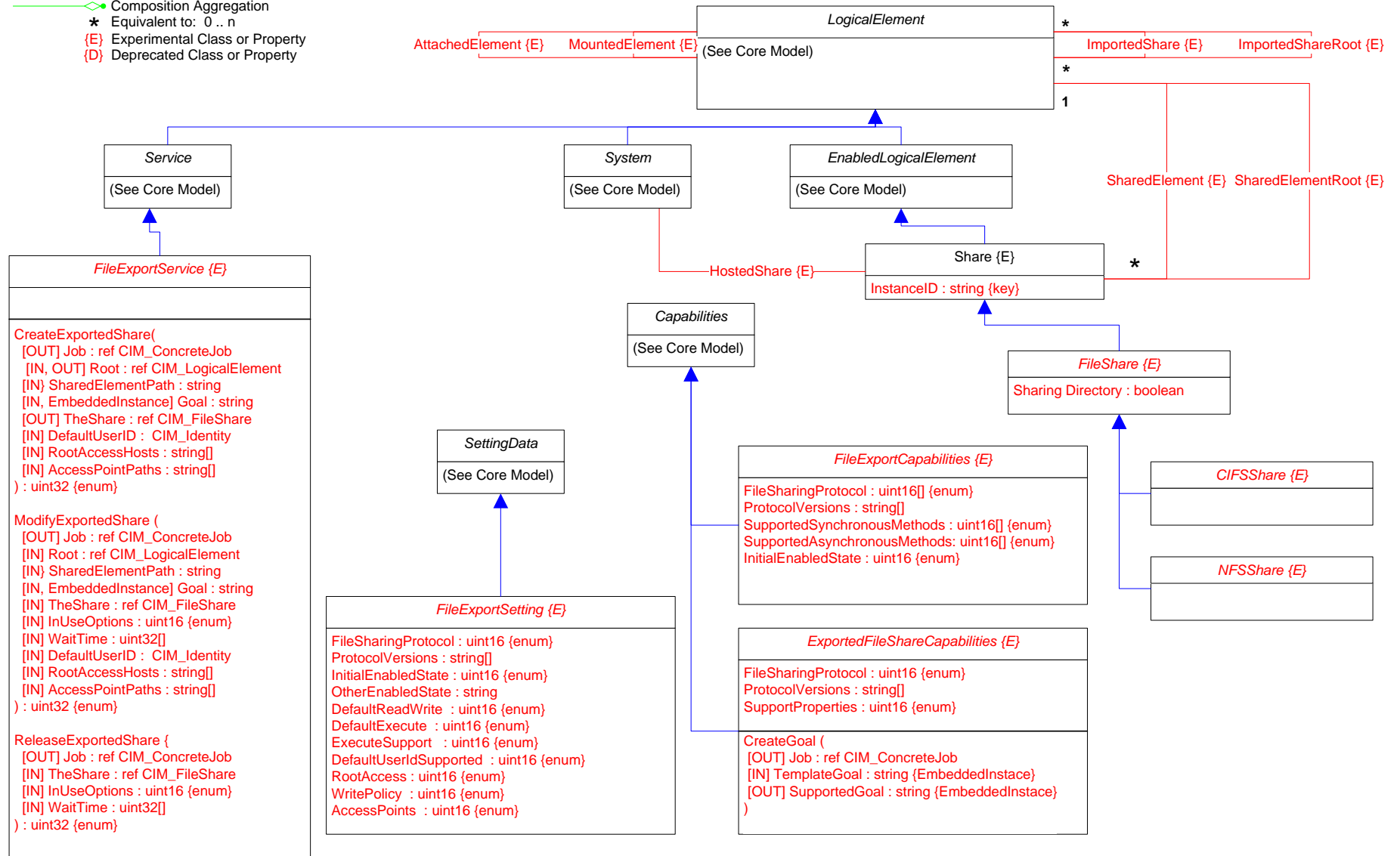



Page 4 : Remote File Systems / File Export Service

- ▲ Inheritance
- Association
- w Association with WEAK reference
- ◇ Aggregation
- w Aggregation with WEAK reference
- ◇ Composition Aggregation
- \* Equivalent to: 0..n
- {E} Experimental Class or Property
- {D} Deprecated Class or Property







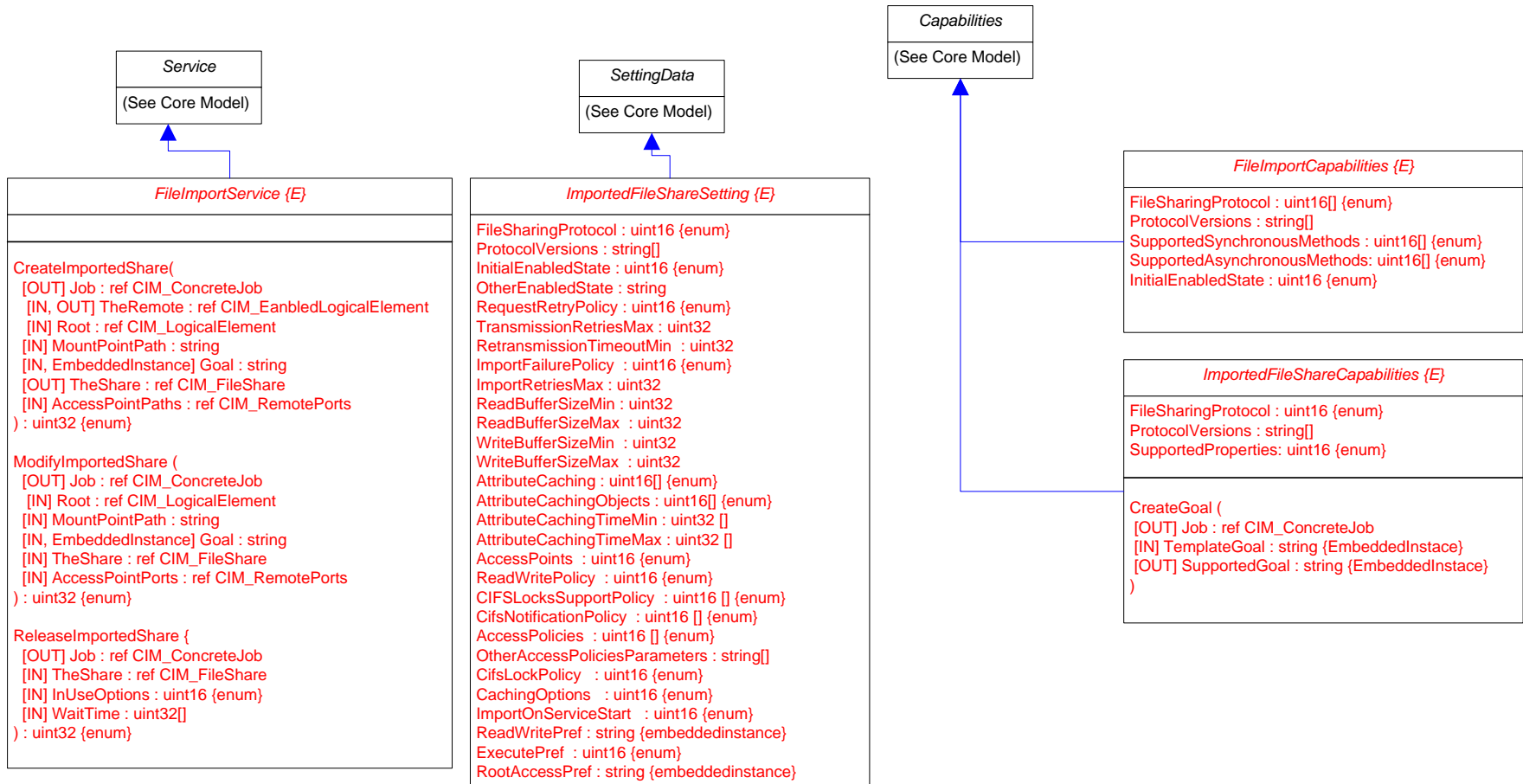



Page 5 : File Import Service

-  Inheritance
-  Association
-  Association with WEAK reference
-  Aggregation
-  Aggregation with WEAK reference
-  Composition Aggregation
-  Equivalent to: 0 .. n
-  {E} Experimental Class or Property
-  {D} Deprecated Class or Property







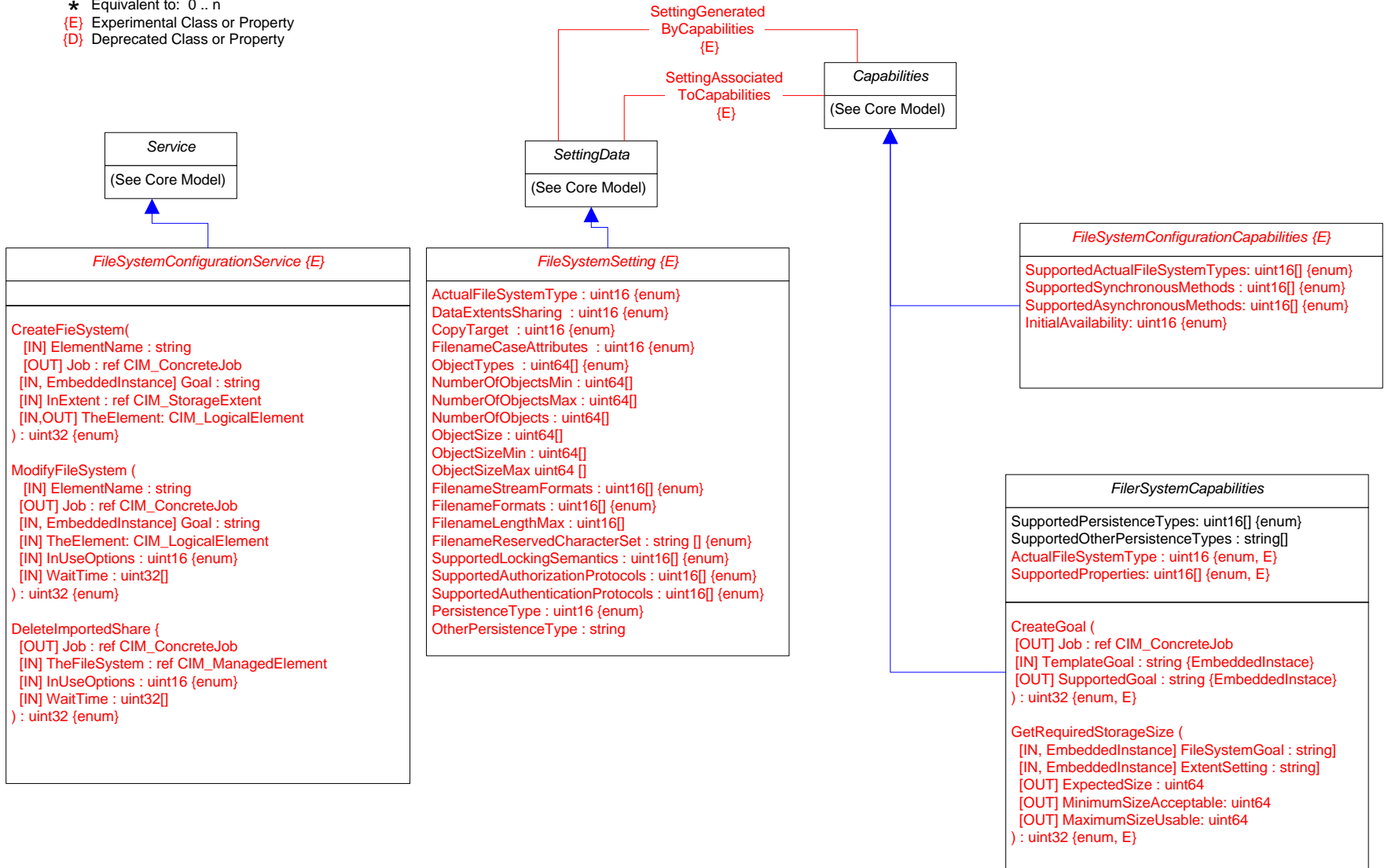



Page 6 : File Import Service

-  Inheritance
-  Association
-  Association with WEAK reference
-  Aggregation
-  Aggregation with WEAK reference
-  Composition Aggregation
-  Equivalent to: 0..n
-  Experimental Class or Property
-  Deprecated Class or Property







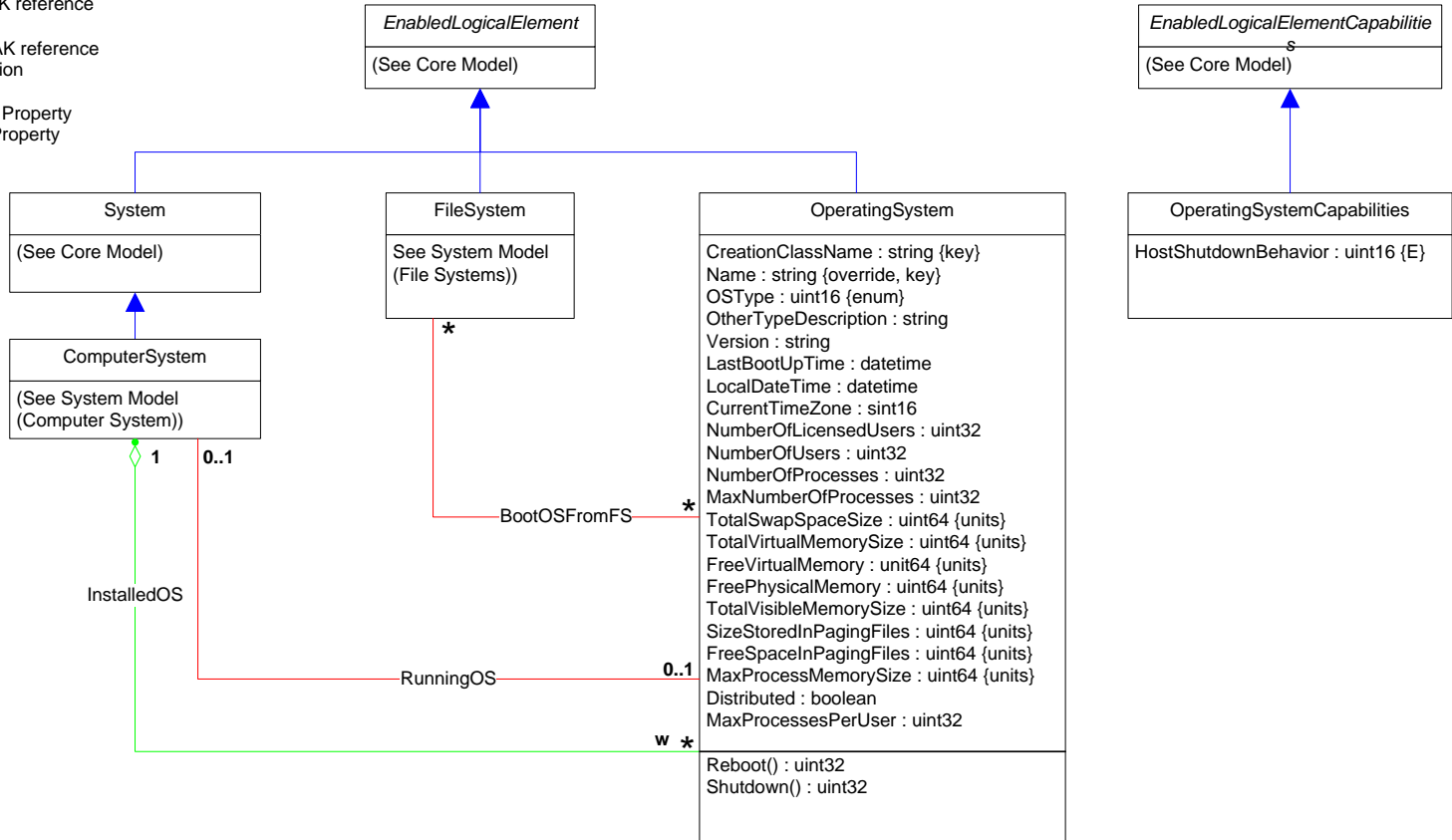

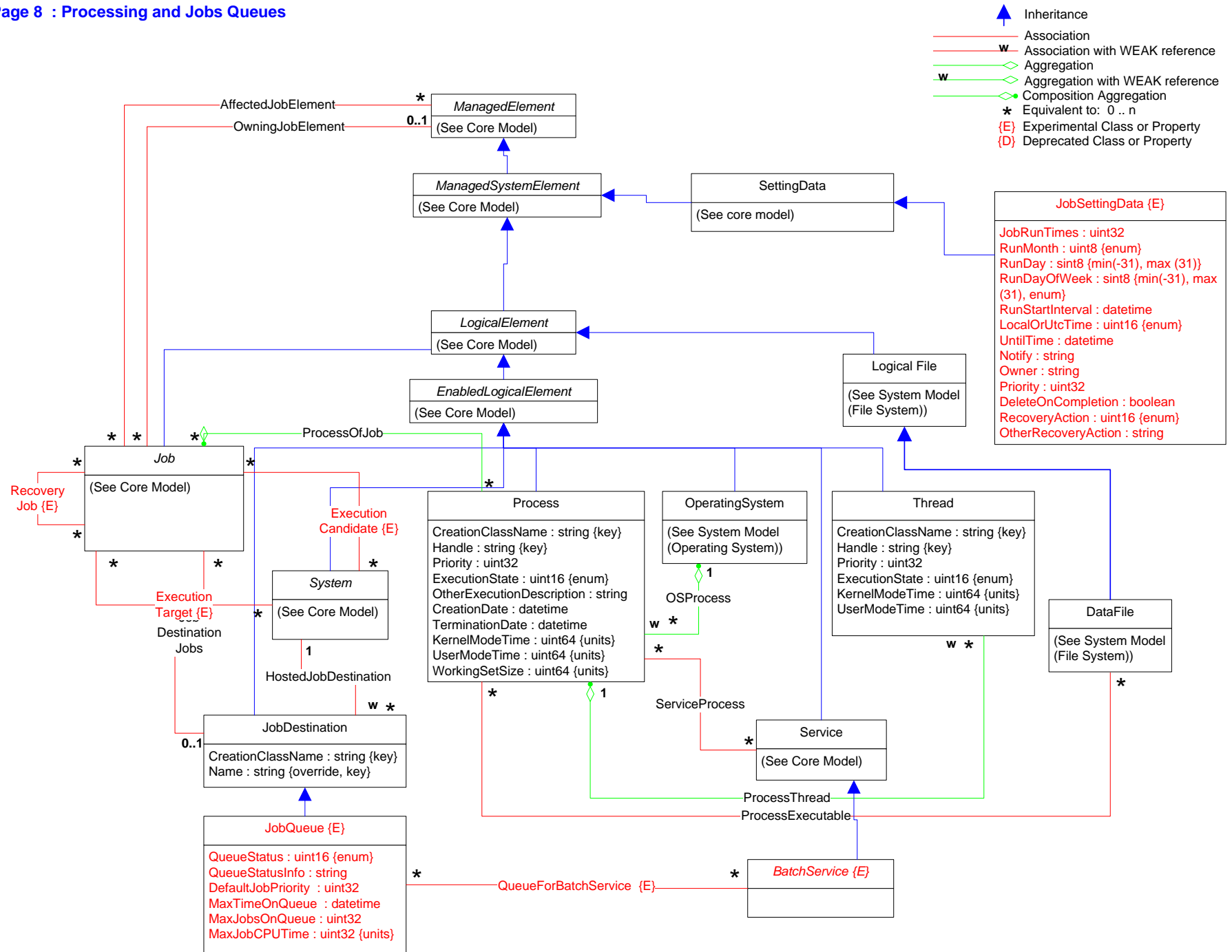
Page 7 : Operating System

-  Inheritance
-  Association
-  Association with WEAK reference
-  Aggregation
-  Aggregation with WEAK reference
-  Composition Aggregation
-  Equivalent to: 0 .. n
-  Experimental Class or Property
-  Deprecated Class or Property









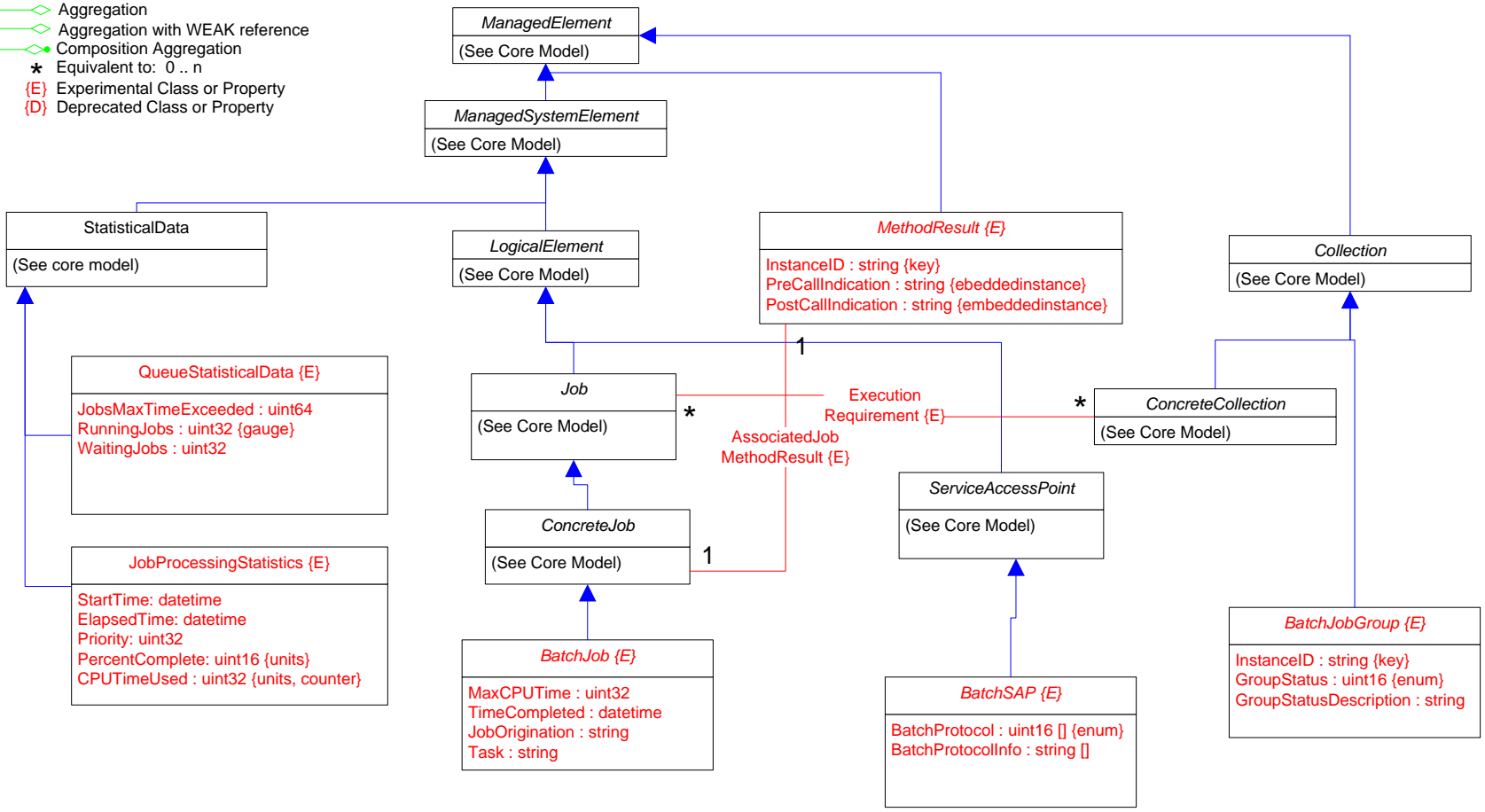

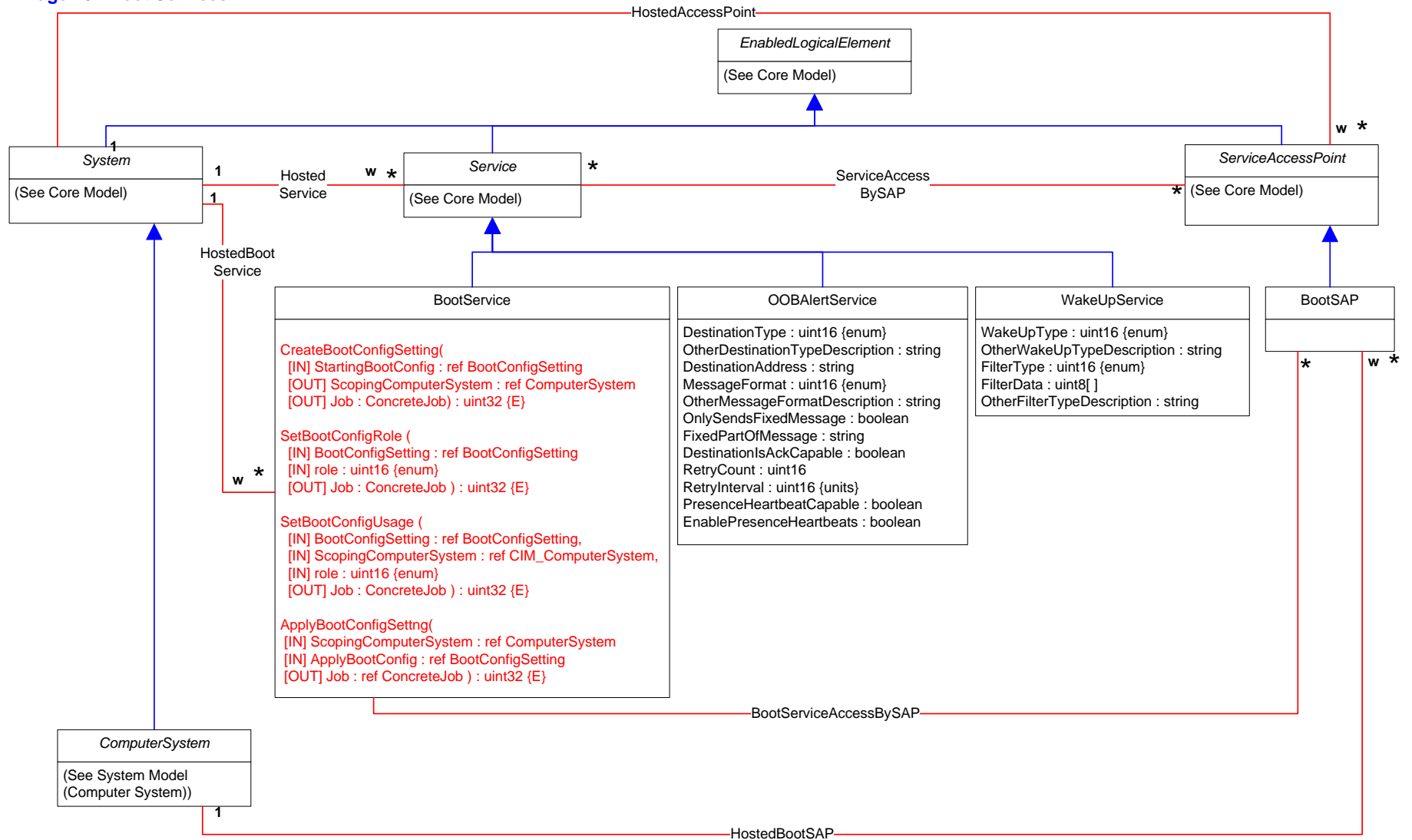





-  Inheritance
-  Association
-  Association with WEAK reference
-  Aggregation
-  Aggregation with WEAK reference
-  Composition Aggregation
-  Equivalent to: 0..n
- (E) Experimental Class or Property
- (D) Deprecated Class or Property





- Inheritance
- Association
- Association with WEAK reference
- Aggregation
- Aggregation with WEAK reference
- Composition Aggregation
- Equivalent to: 0 .. n
- (E) Experimental Class or Property
- (D) Deprecated Class or Property

Page 11 : Boot Services

-  Inheritance
-  Association
-  Association with WEAK reference
-  Aggregation
-  Aggregation with WEAK reference
-  Composition Aggregation
-  Equivalent to: 0 .. n
-  Experimental Class or Property
-  Deprecated Class or Property

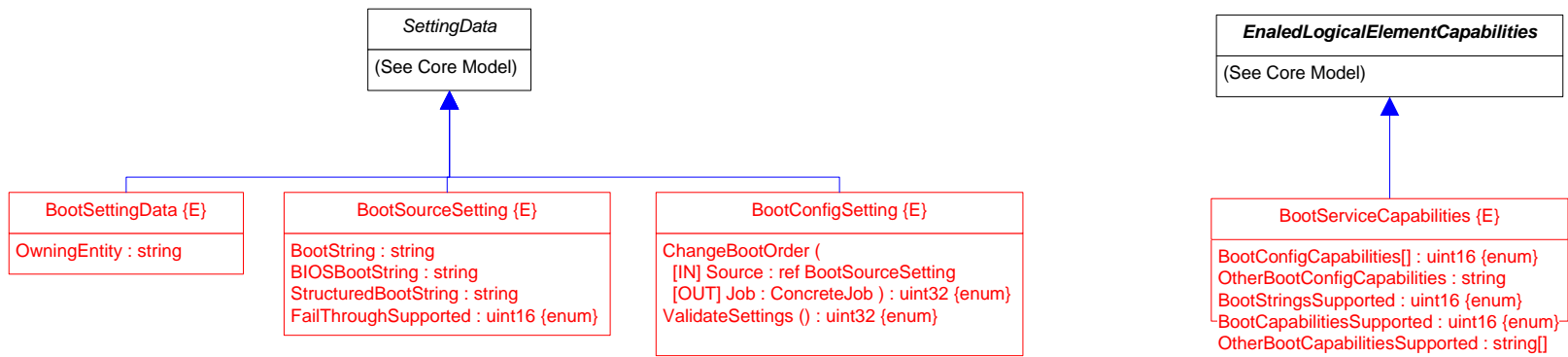

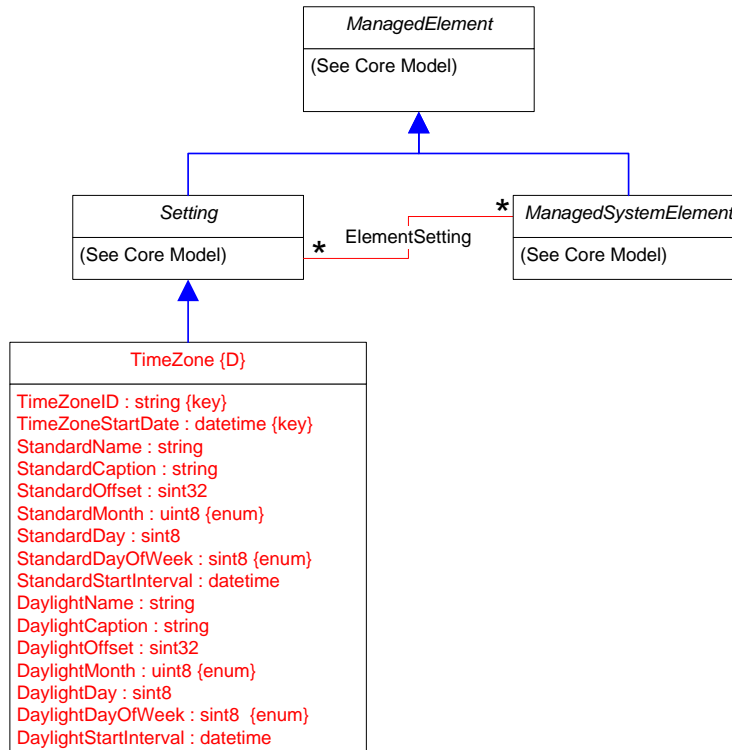
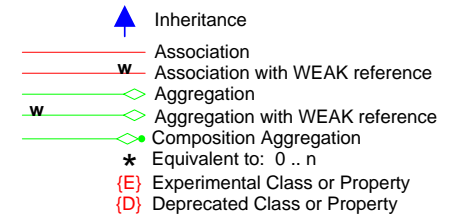

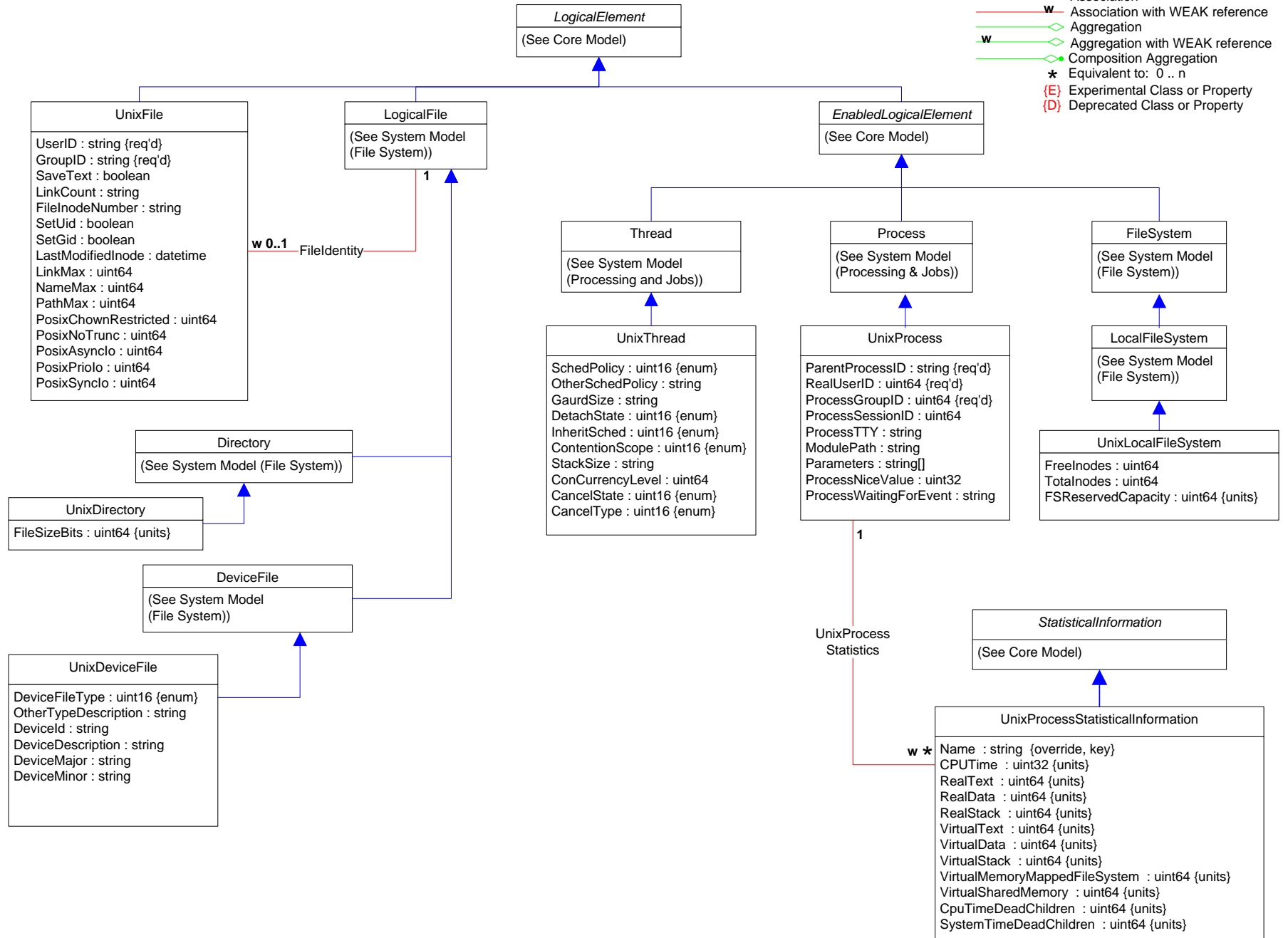
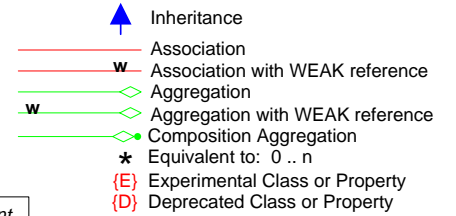

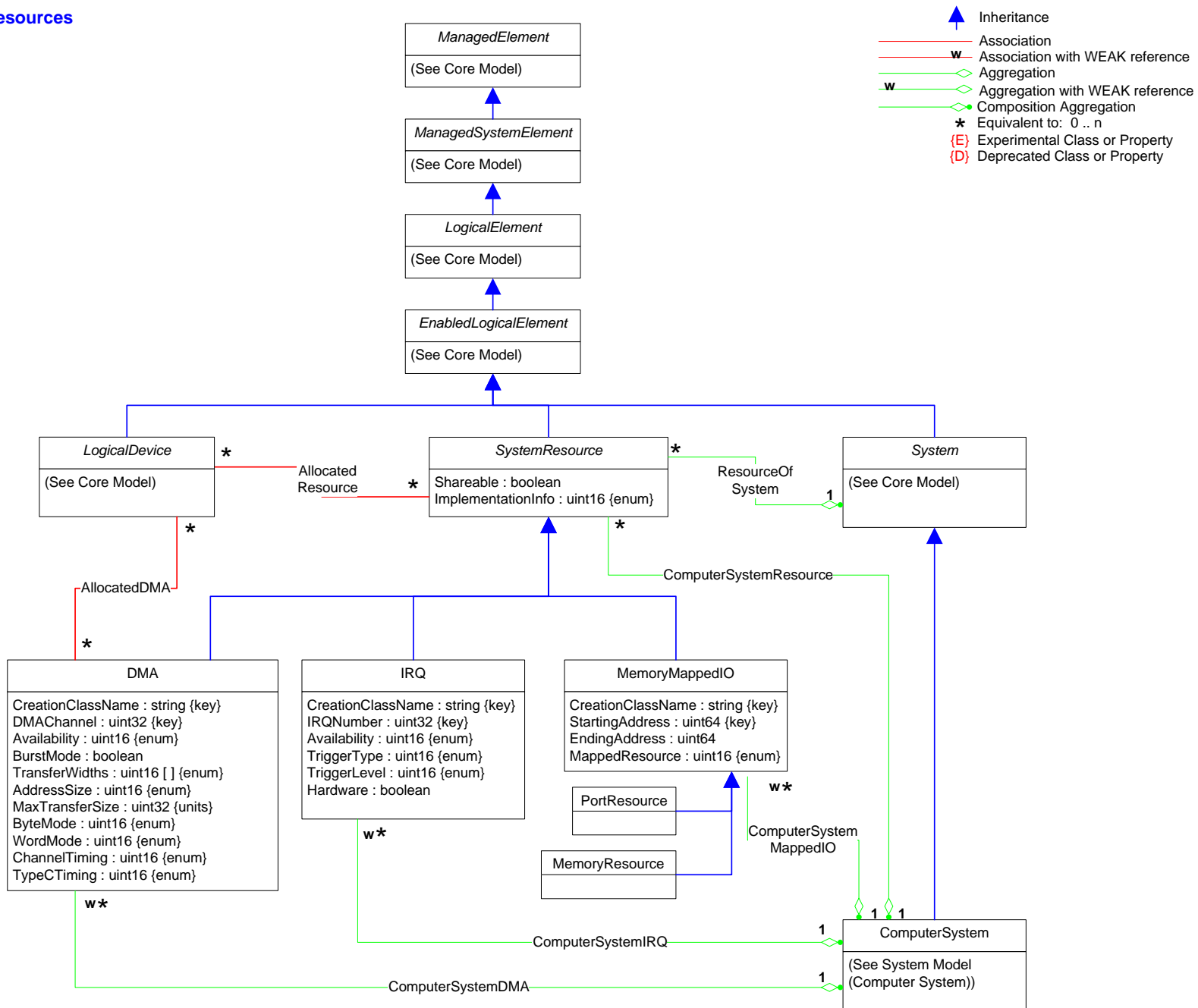

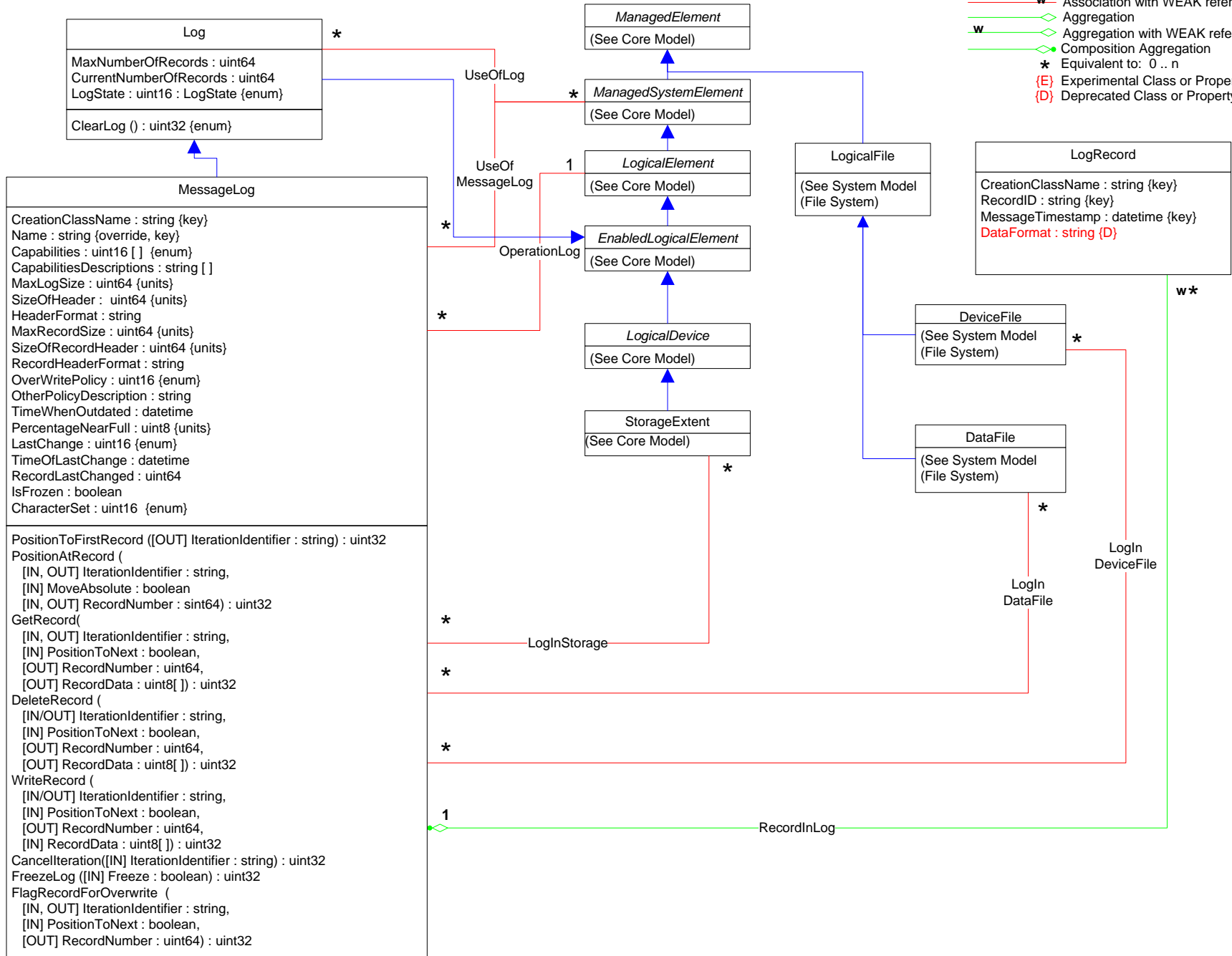
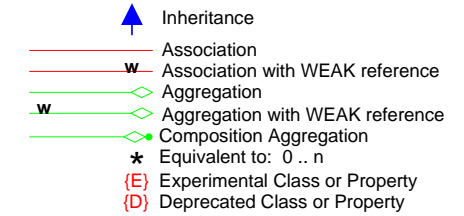

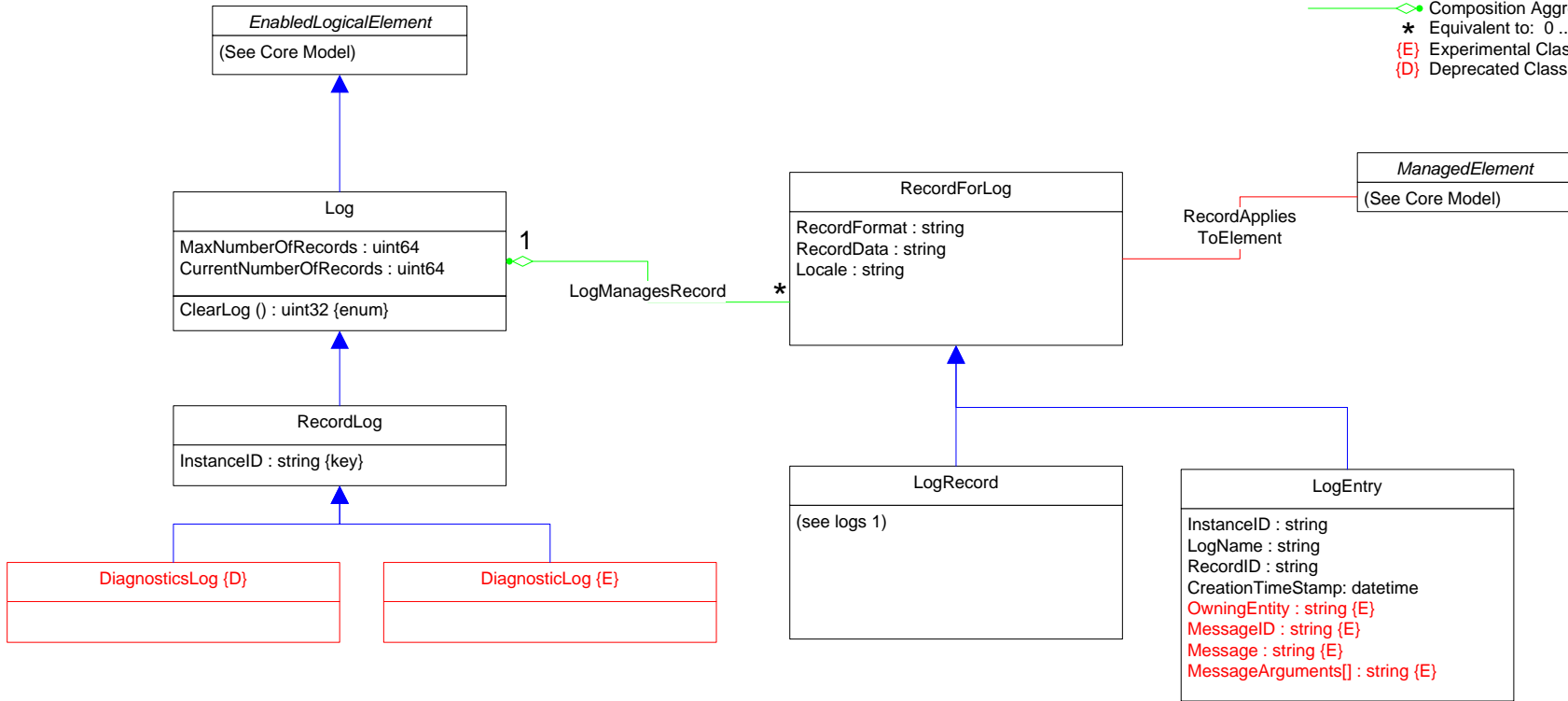
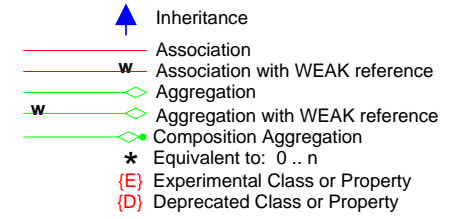



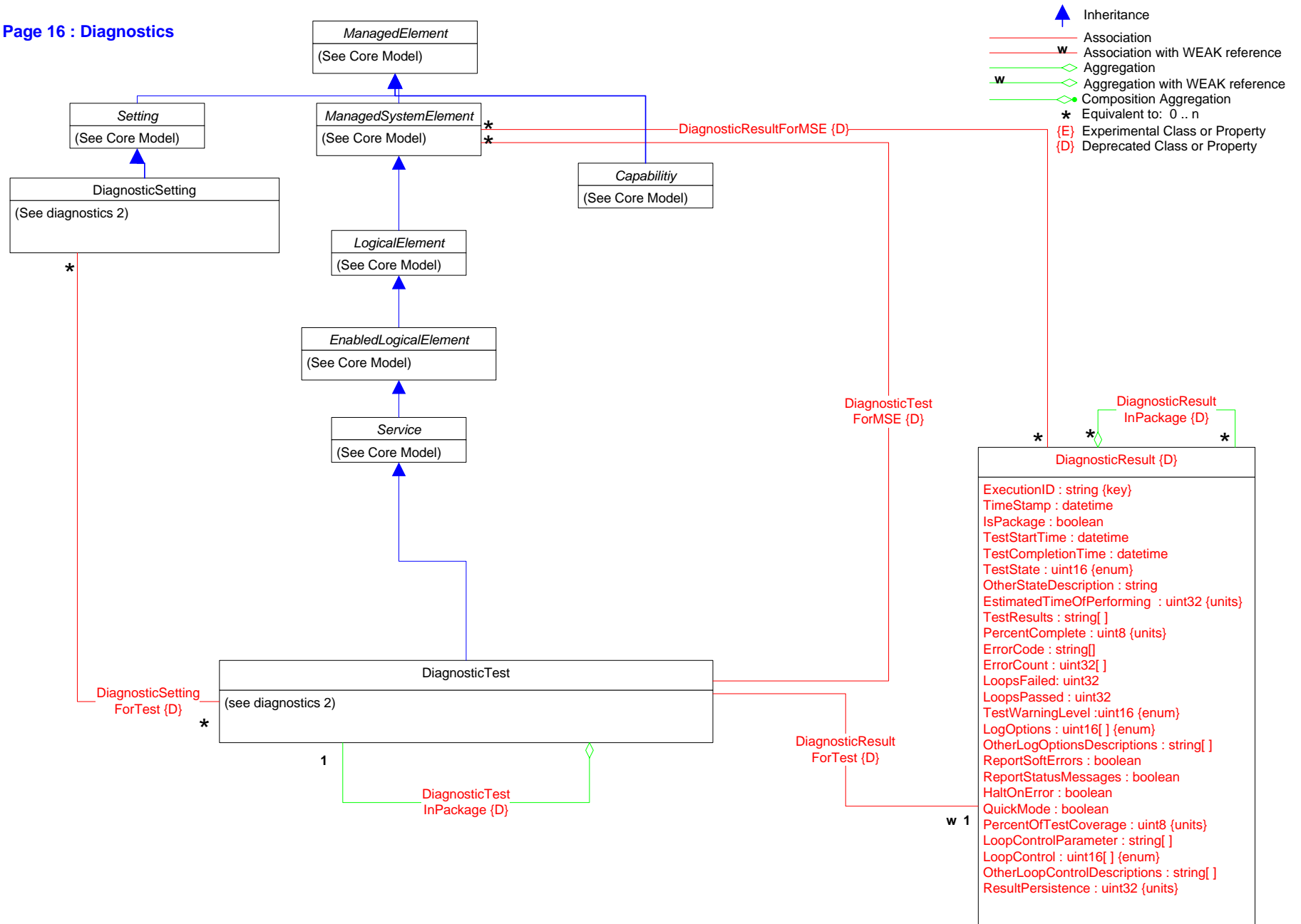

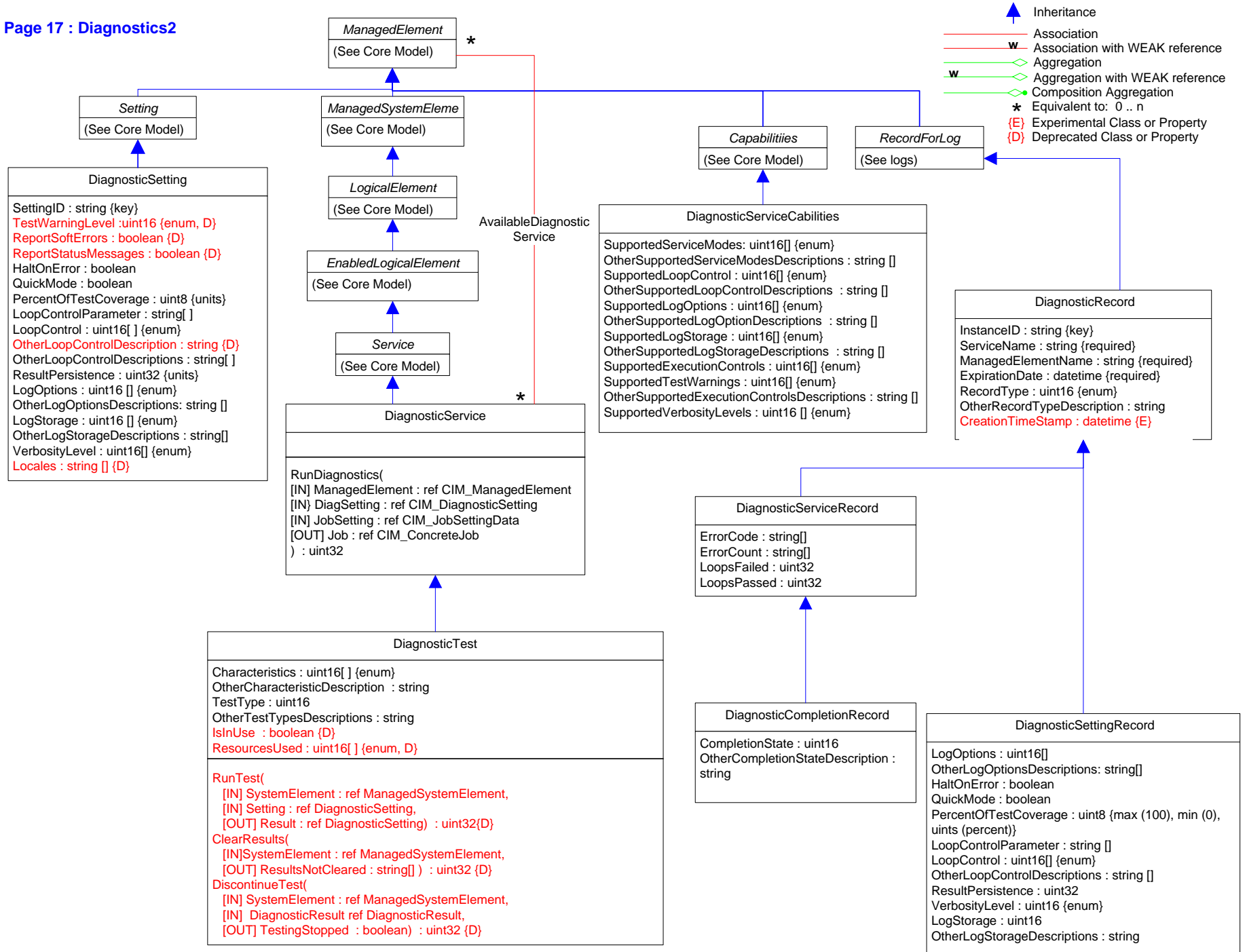

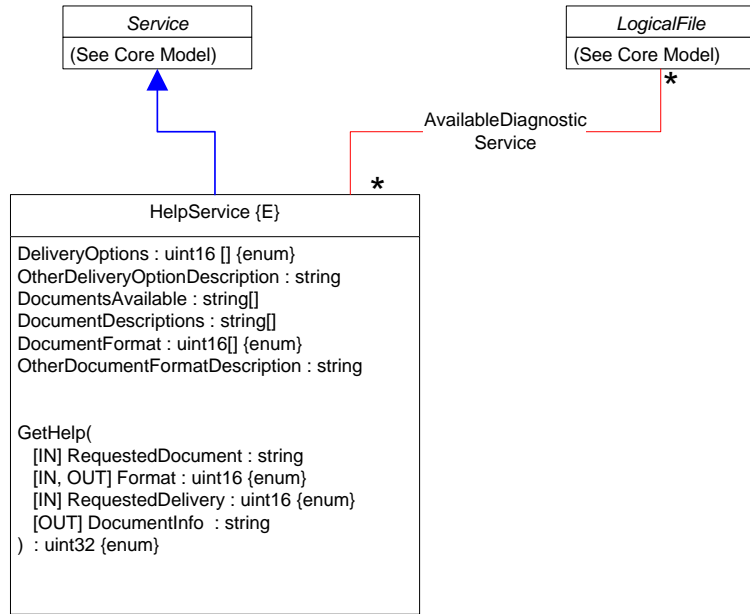

- Inheritance
- Association
- Association with WEAK reference
- Aggregation
- Aggregation with WEAK reference
- Composition Aggregation
- Equivalent to: 0 .. n
- Experimental Class or Property
- Deprecated Class or Property

Page 19 : Virtualization

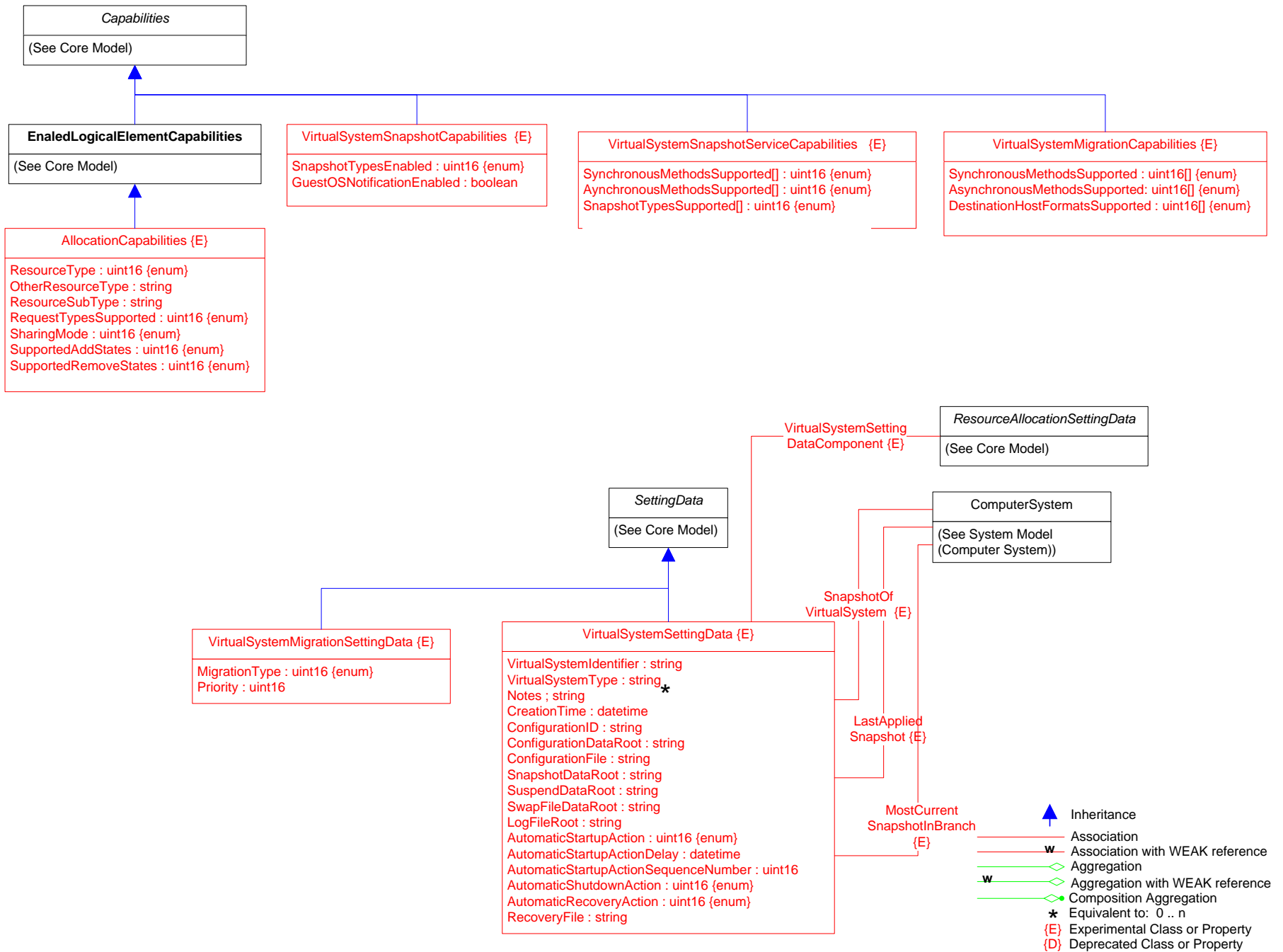

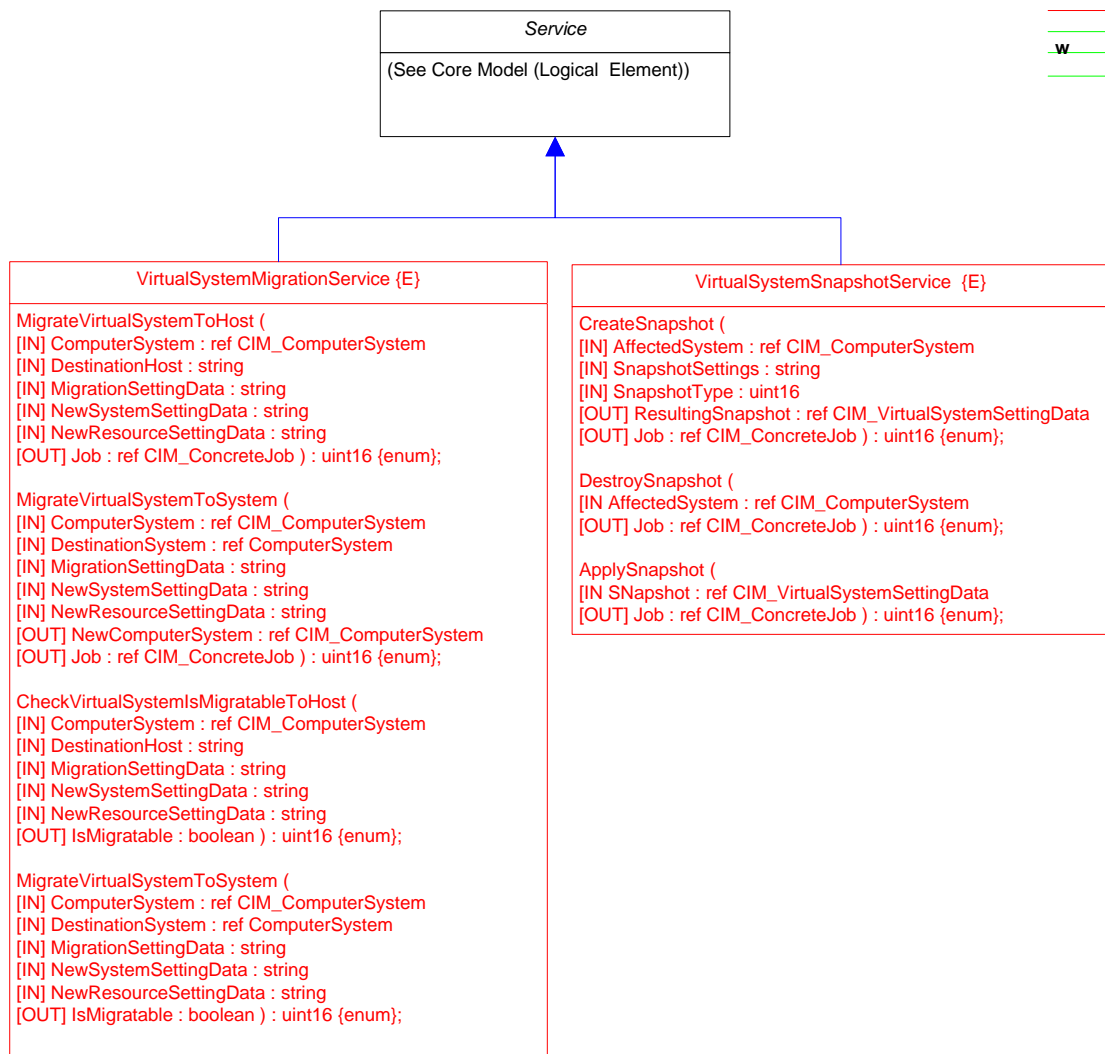
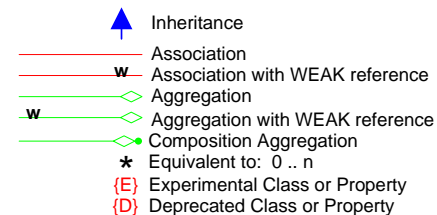

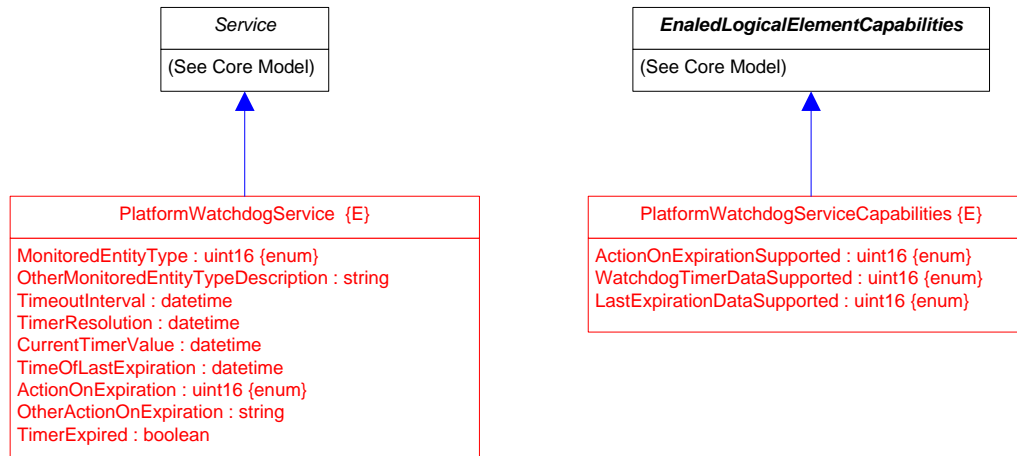
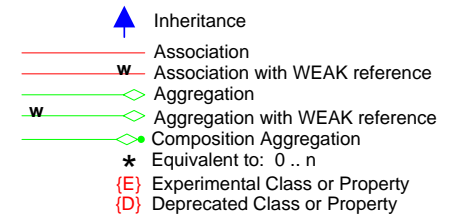

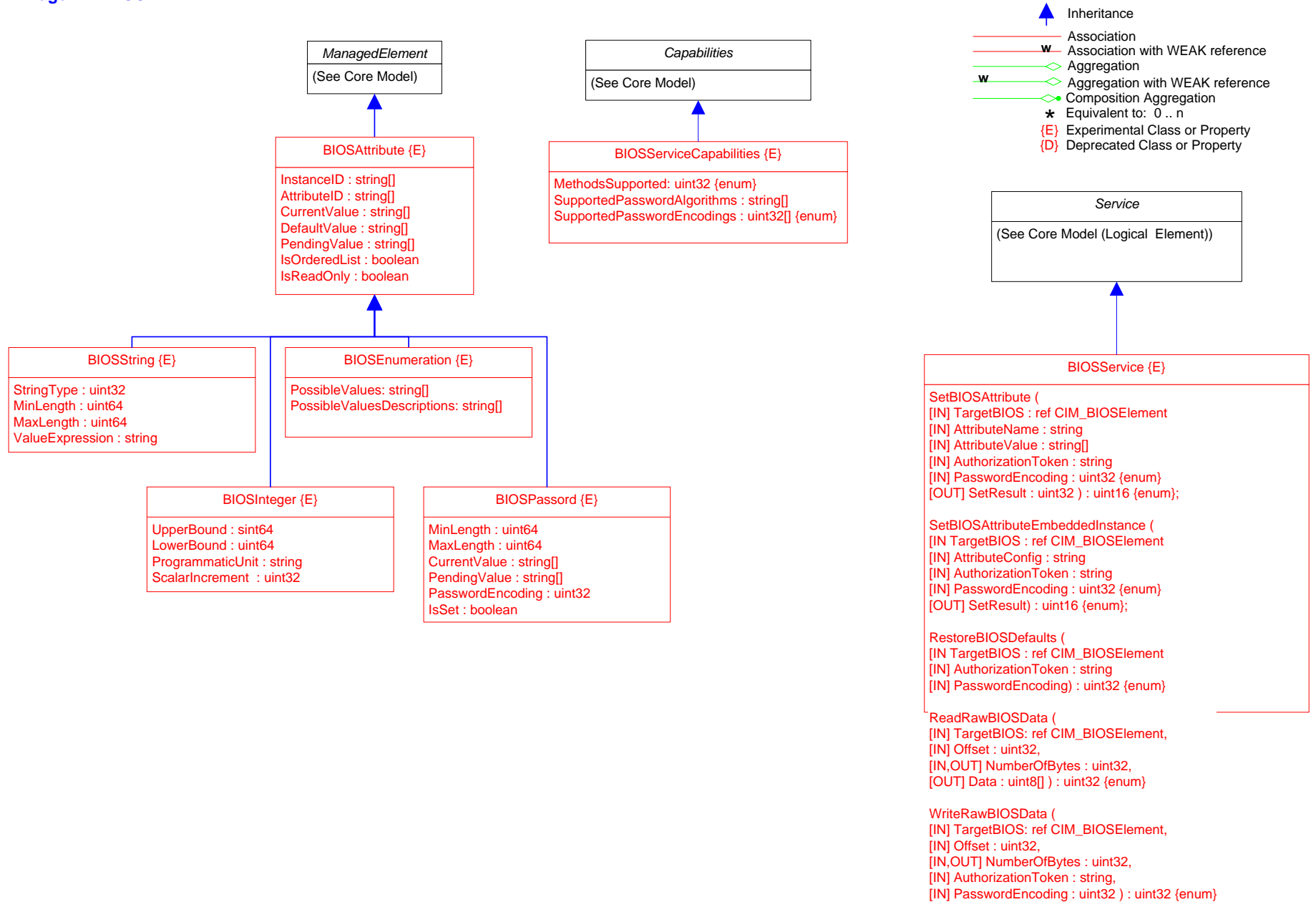

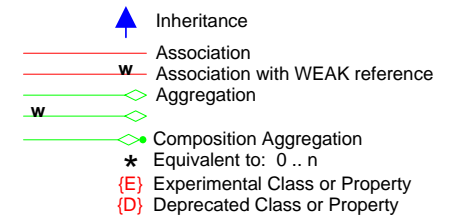
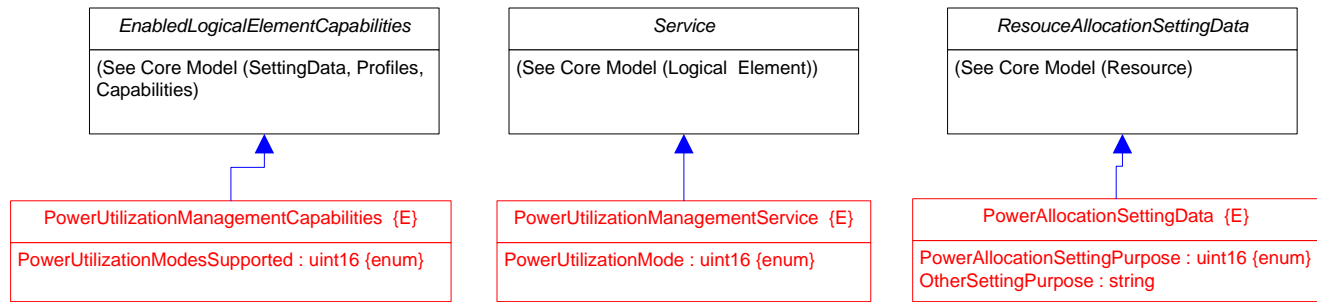



Page 22 : Association Hierarchy

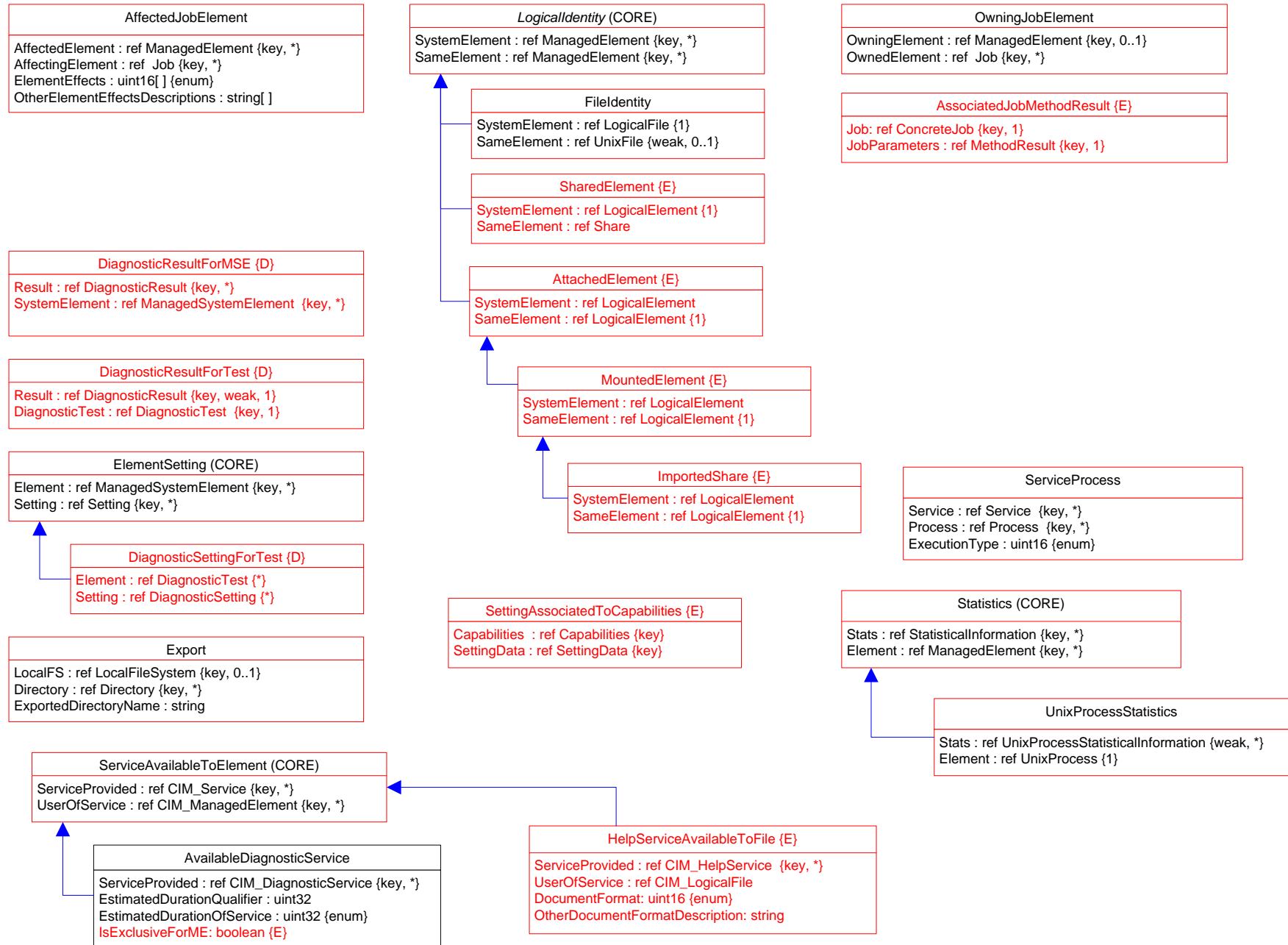

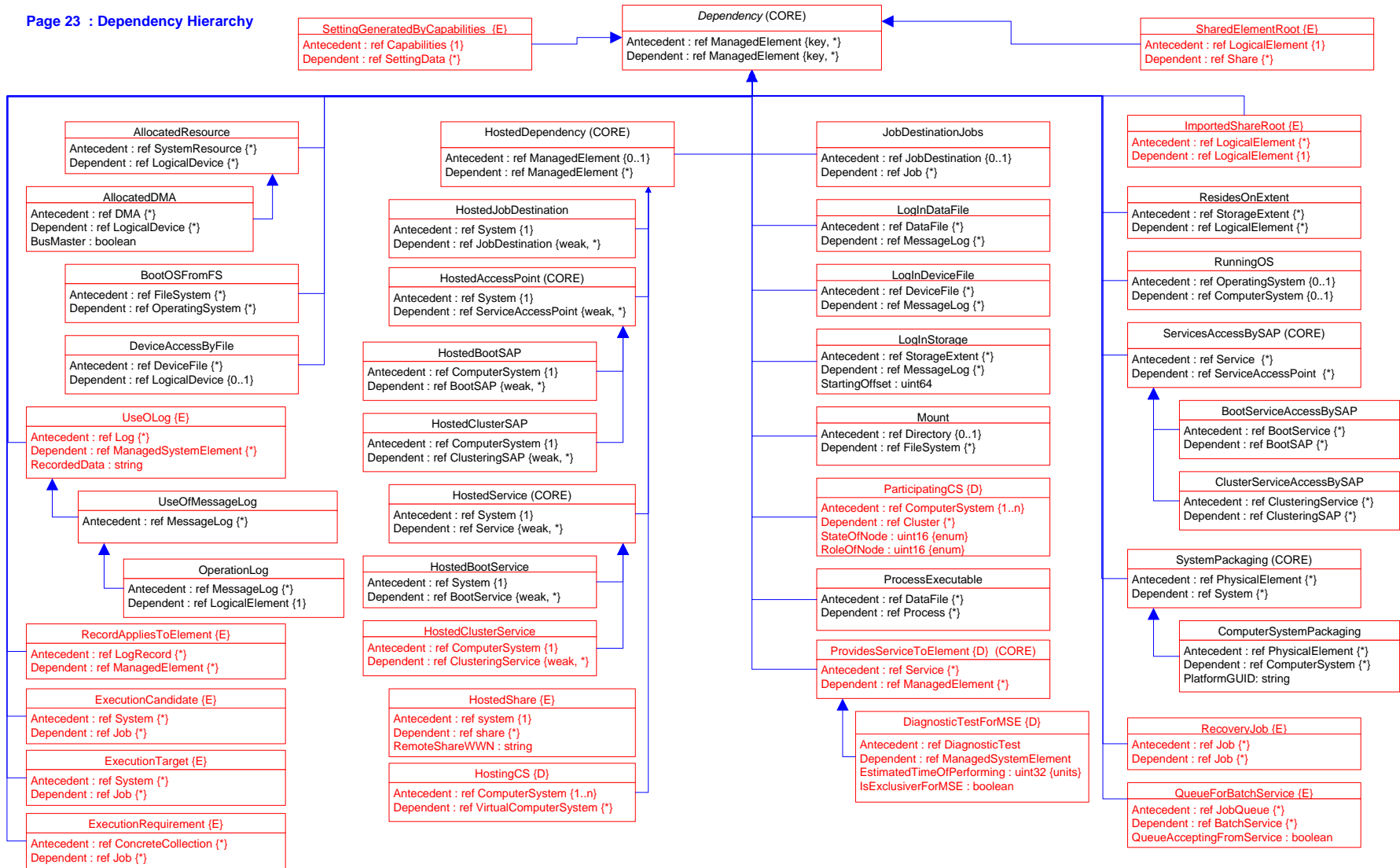

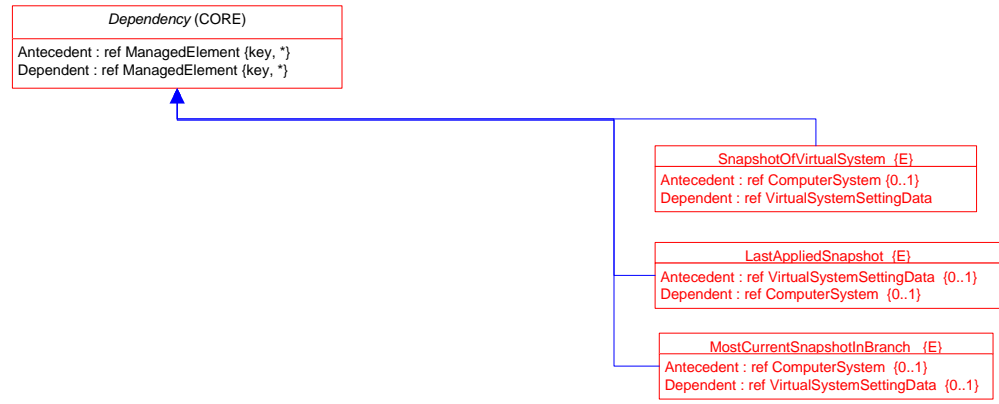

Page 25 : Aggregation Hierarchy

