

Title : System Specification V2.11 (UML diagram)

Filename : CIM_System.vsd

Author : DMTF Core Schema WG

Date : 12/02/2005

Page 1 : Overview

Page 2 : Computer System

Page 3 : Local File Systems

Page 4 : Remote FS/File Export

Page 5 : File Import

Page 6 : FileSystemService

Page 7 : Operating System

Page 8 : Processing and Job Queues

Page 9 : Jobs 2

Page 10 : Boot Service

Page 11 : Time

Page 12 : UNIX

Page 13 : System Resources

Page 14 : Message Logs

Page 15 : Logs 2

Page 16 : Diagnostics 1

Page 17 : Diagnostics 2

Page 18 : Help

Page 19 : Association Hierarchy

Page 20 : Dependency Hierarchy

Page 21 : Aggregation Hierarchy

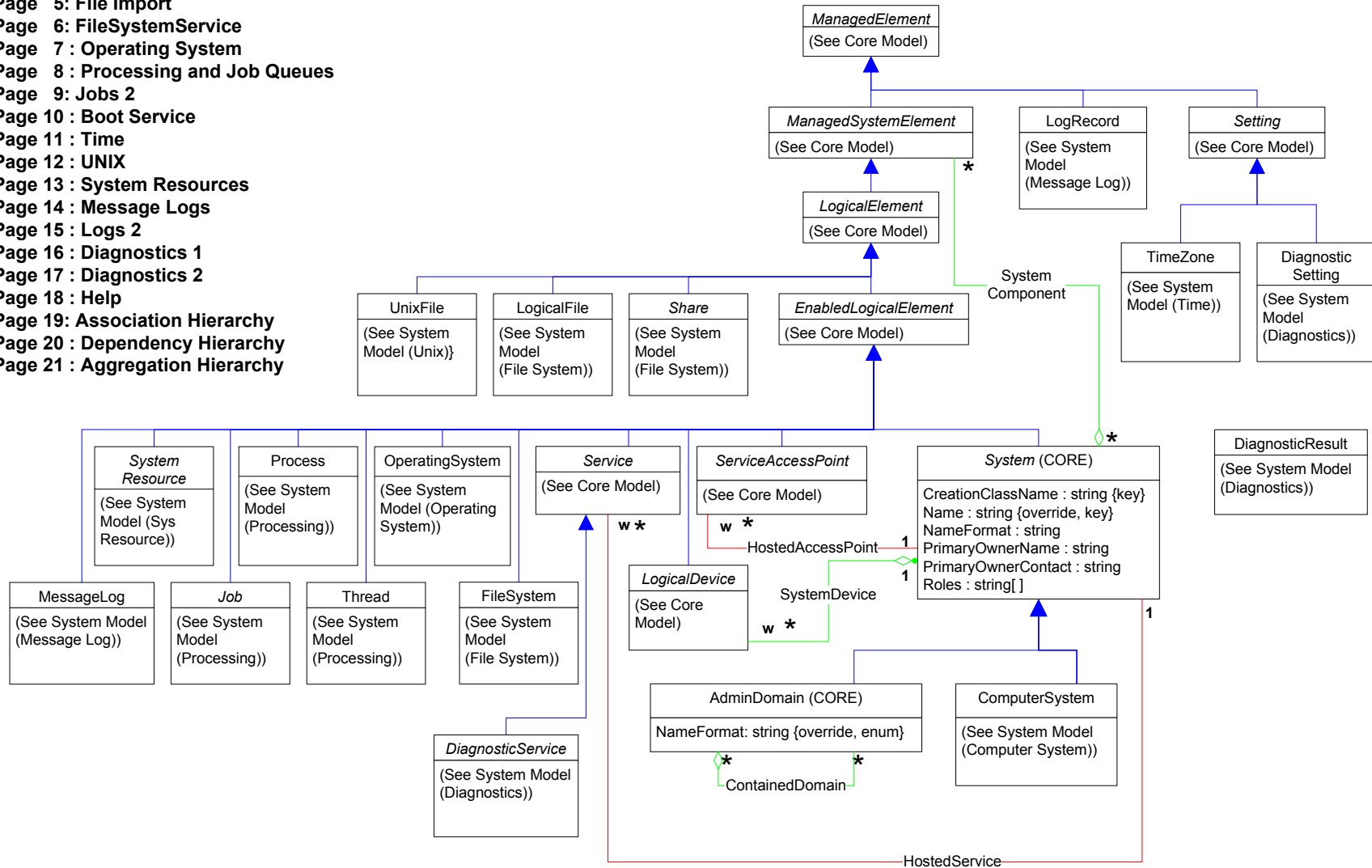
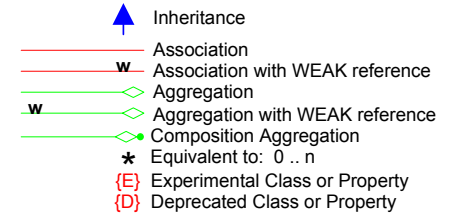

Page 2 : ComputerSystem

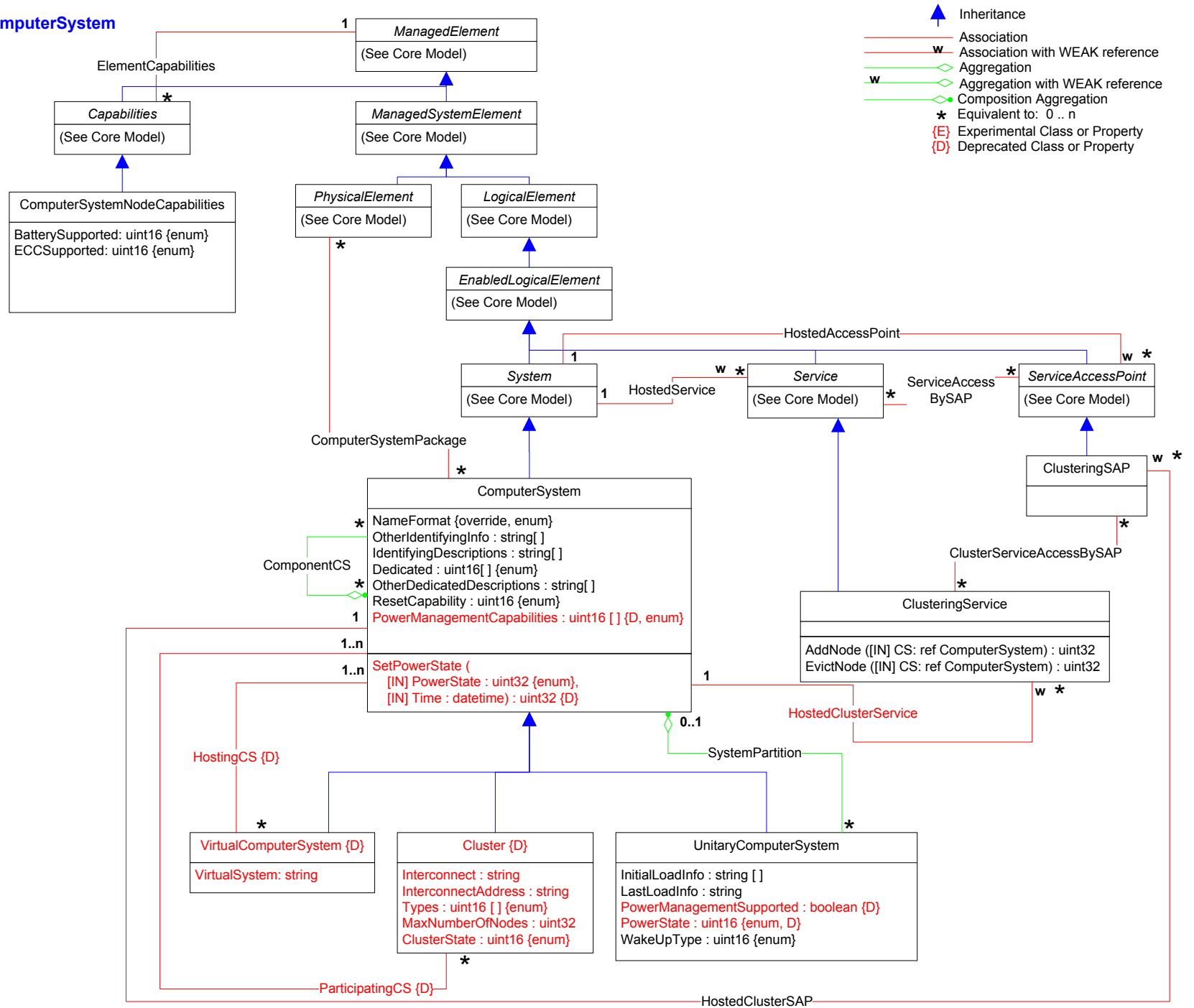

Page 3 : Local File Systems

- ▲ Inheritance
- Association
- w Association with WEAK reference
- ◇ Aggregation
- w◇ Aggregation with WEAK reference
- ◊ Composition Aggregation
- * Equivalent to: 0 .. n
- {E} Experimental Class or Property
- {D} Deprecated Class or Property

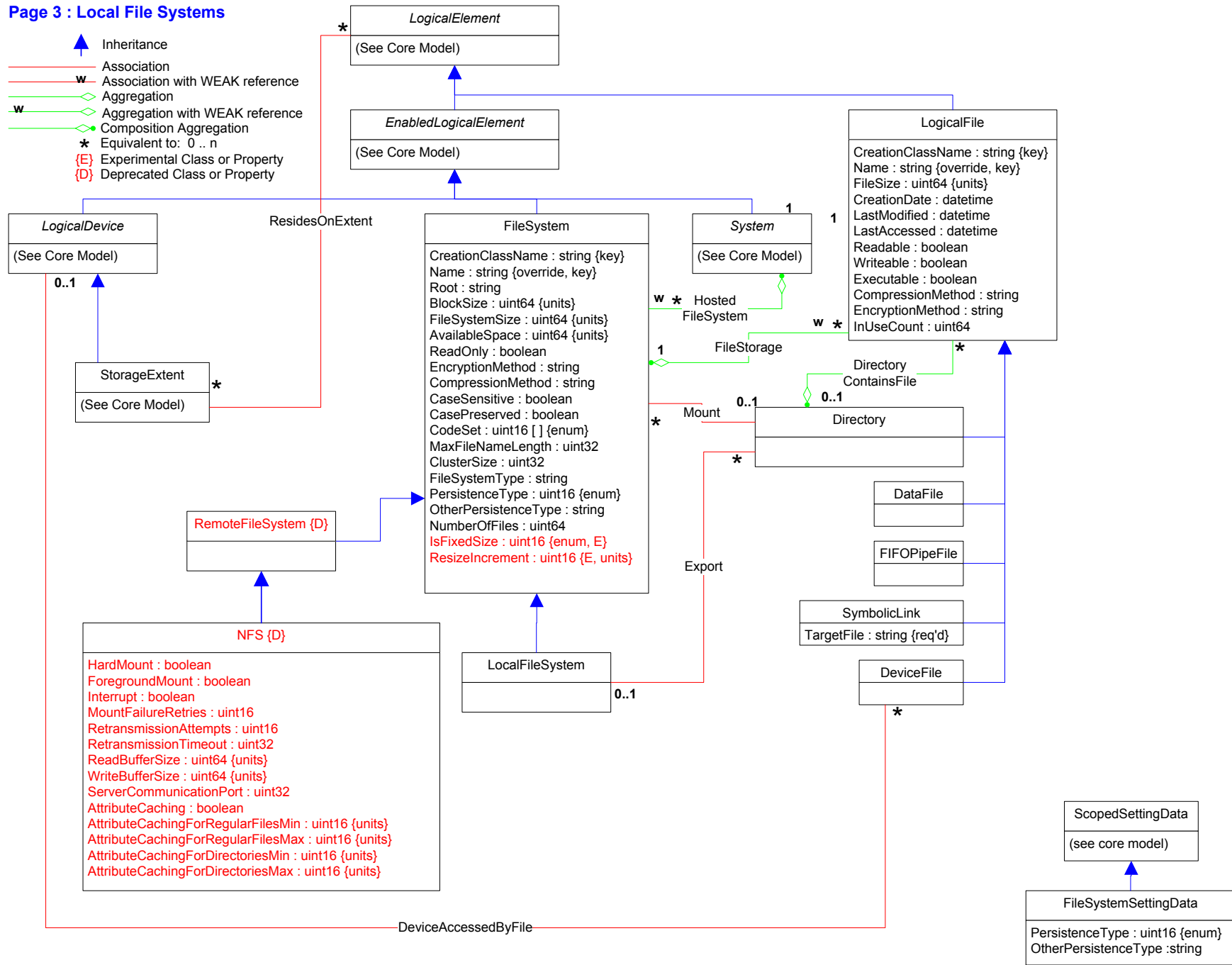





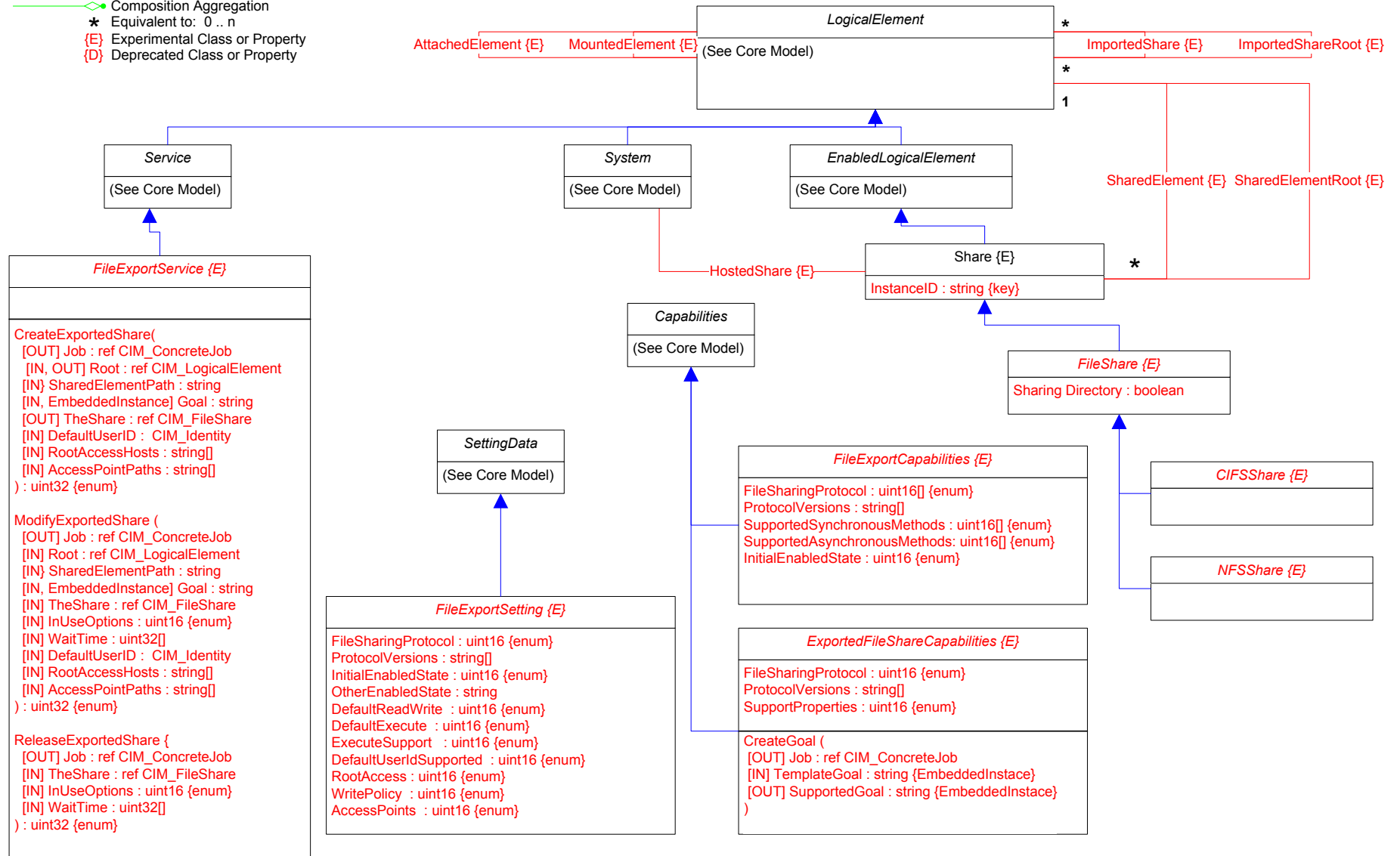



Page 4 : Remote File Systems / File Export Service

- ▲ Inheritance
- Association
- w Association with WEAK reference
- ◇ Aggregation
- w◇ Aggregation with WEAK reference
- ◇ Composition Aggregation
- * Equivalent to: 0..n
- {E} Experimental Class or Property
- {D} Deprecated Class or Property







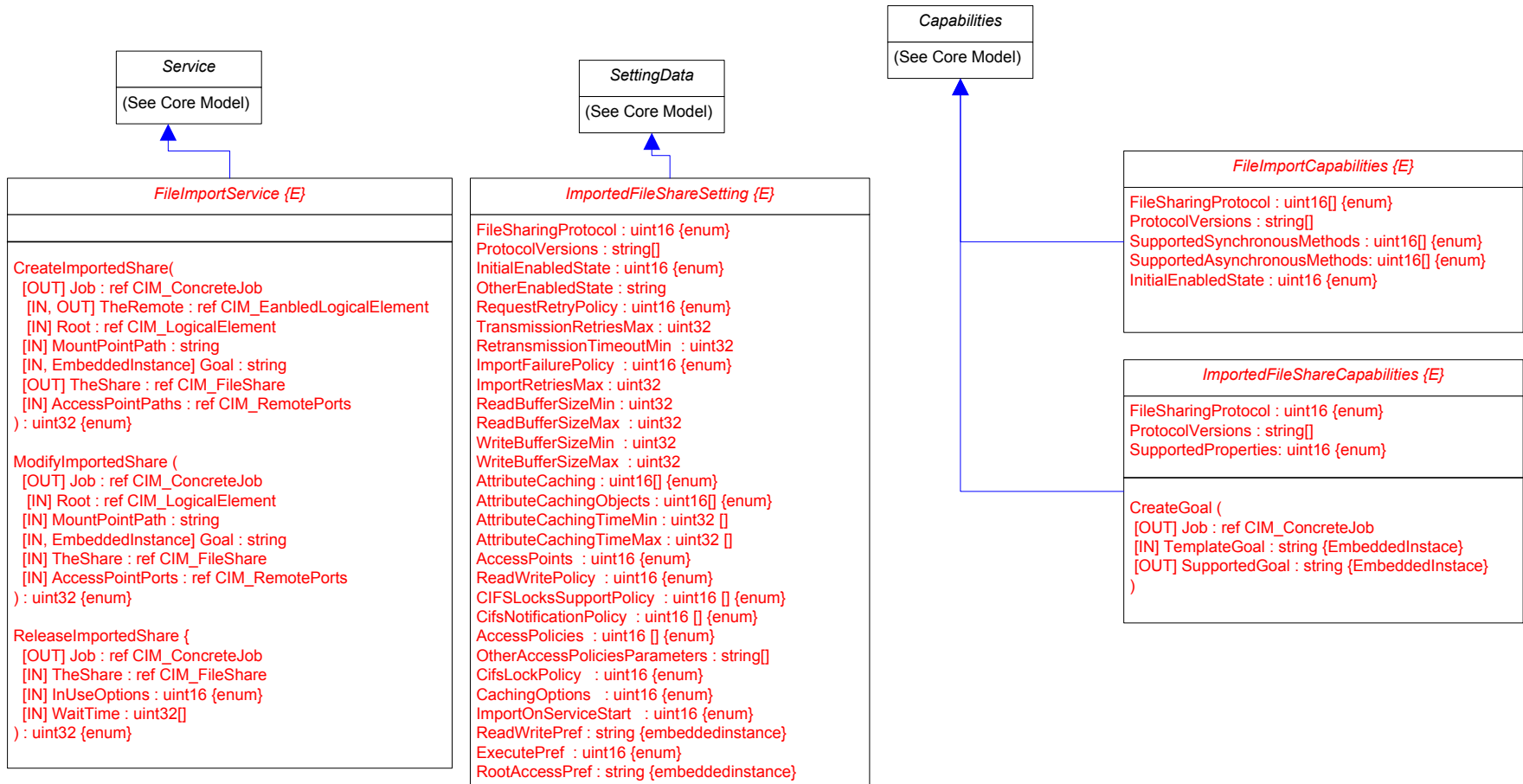



Page 5 : File Import Service

-  Inheritance
-  Association
-  Association with WEAK reference
-  Aggregation
-  Aggregation with WEAK reference
-  Composition Aggregation
-  Equivalent to: 0 .. n
-  {E} Experimental Class or Property
-  {D} Deprecated Class or Property







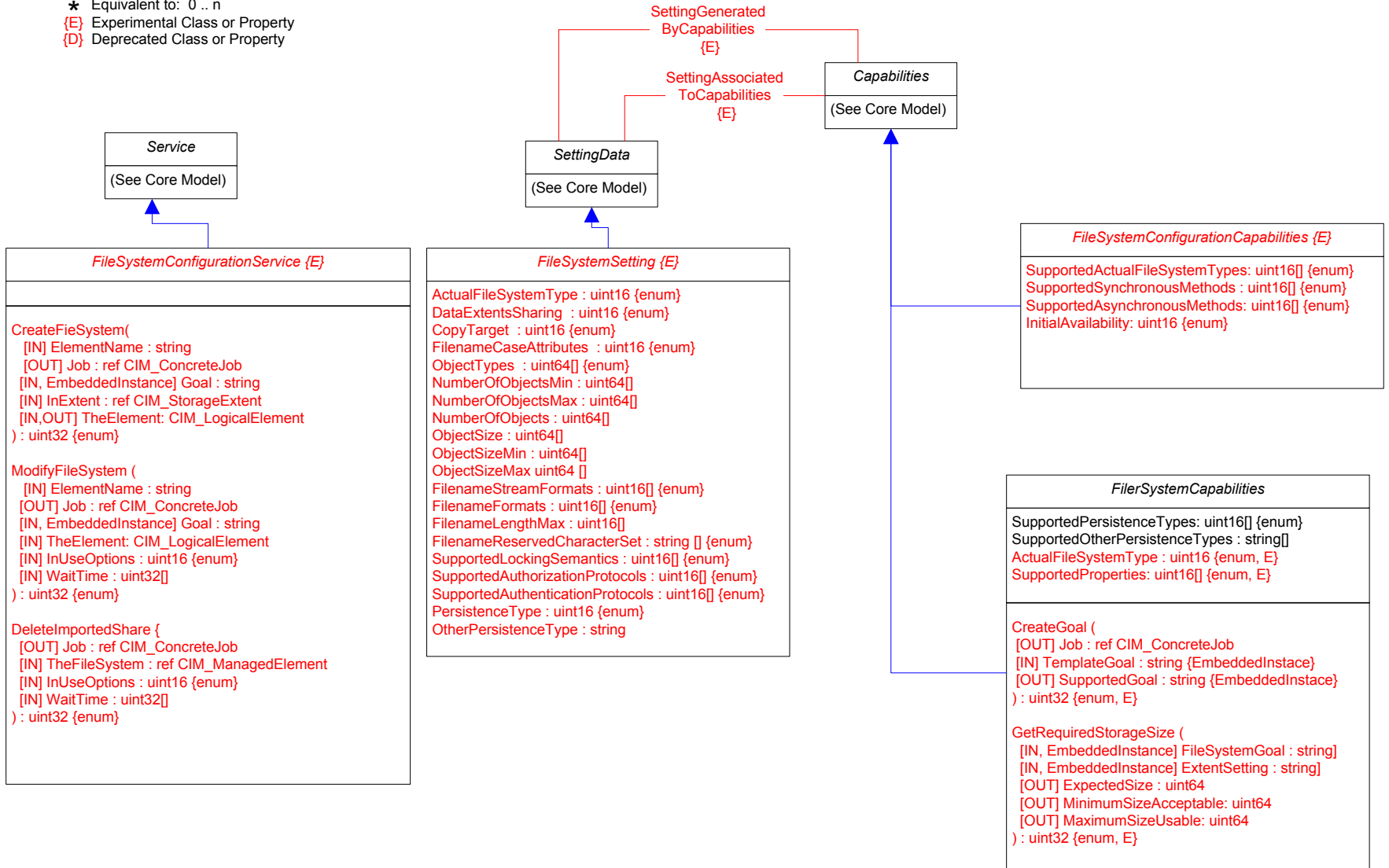



Page 6 : File Import Service

-  Inheritance
-  Association
-  Association with WEAK reference
-  Aggregation
-  Aggregation with WEAK reference
-  Composition Aggregation
-  Equivalent to: 0 .. n
-  Experimental Class or Property
-  Deprecated Class or Property







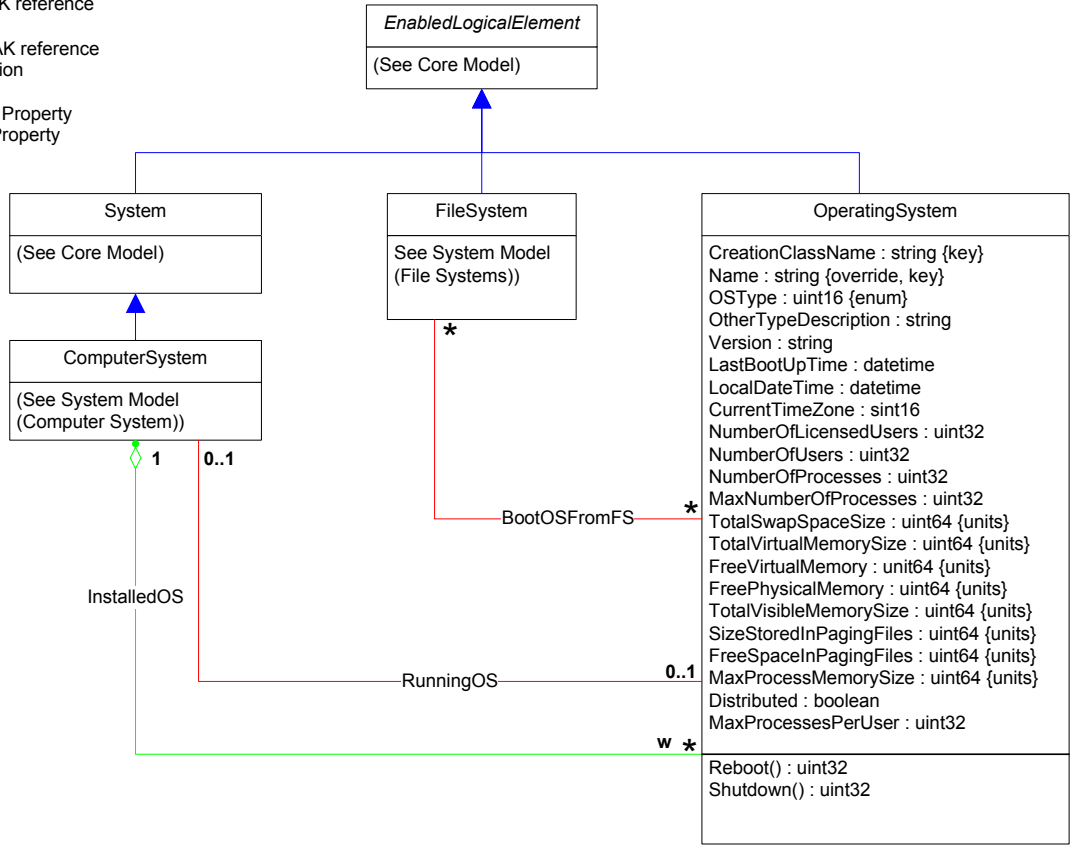

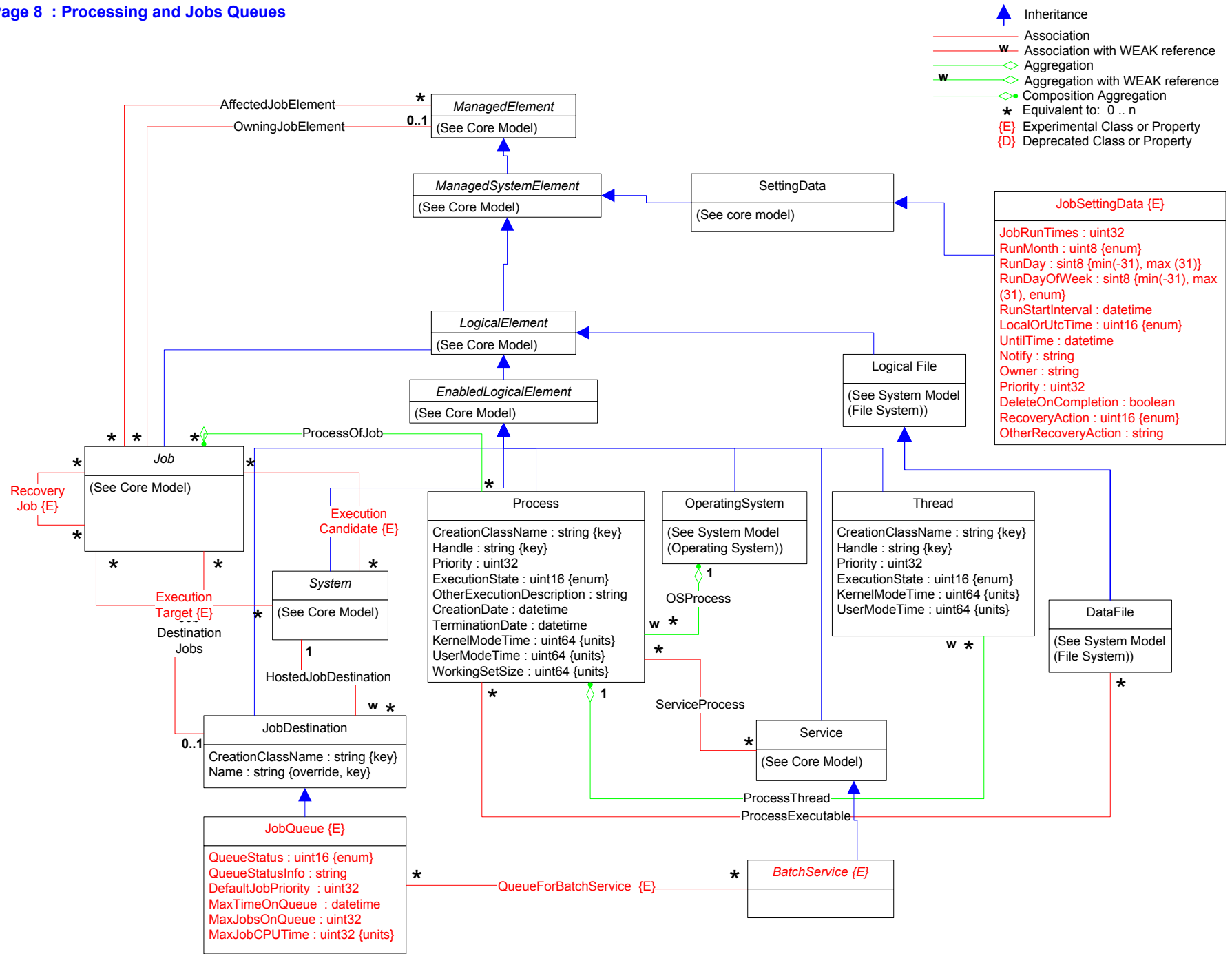

Page 7 : Operating System

-  Inheritance
-  Association
-  Association with WEAK reference
-  Aggregation
-  Aggregation with WEAK reference
-  Composition Aggregation
-  Equivalent to: 0 .. n
-  {E} Experimental Class or Property
-  {D} Deprecated Class or Property





-  Inheritance
-  Association
-  Association with WEAK reference
-  Aggregation
-  Aggregation with WEAK reference
-  Composition Aggregation
-  Equivalent to: 0 .. n
-  {E} Experimental Class or Property
-  {D} Deprecated Class or Property

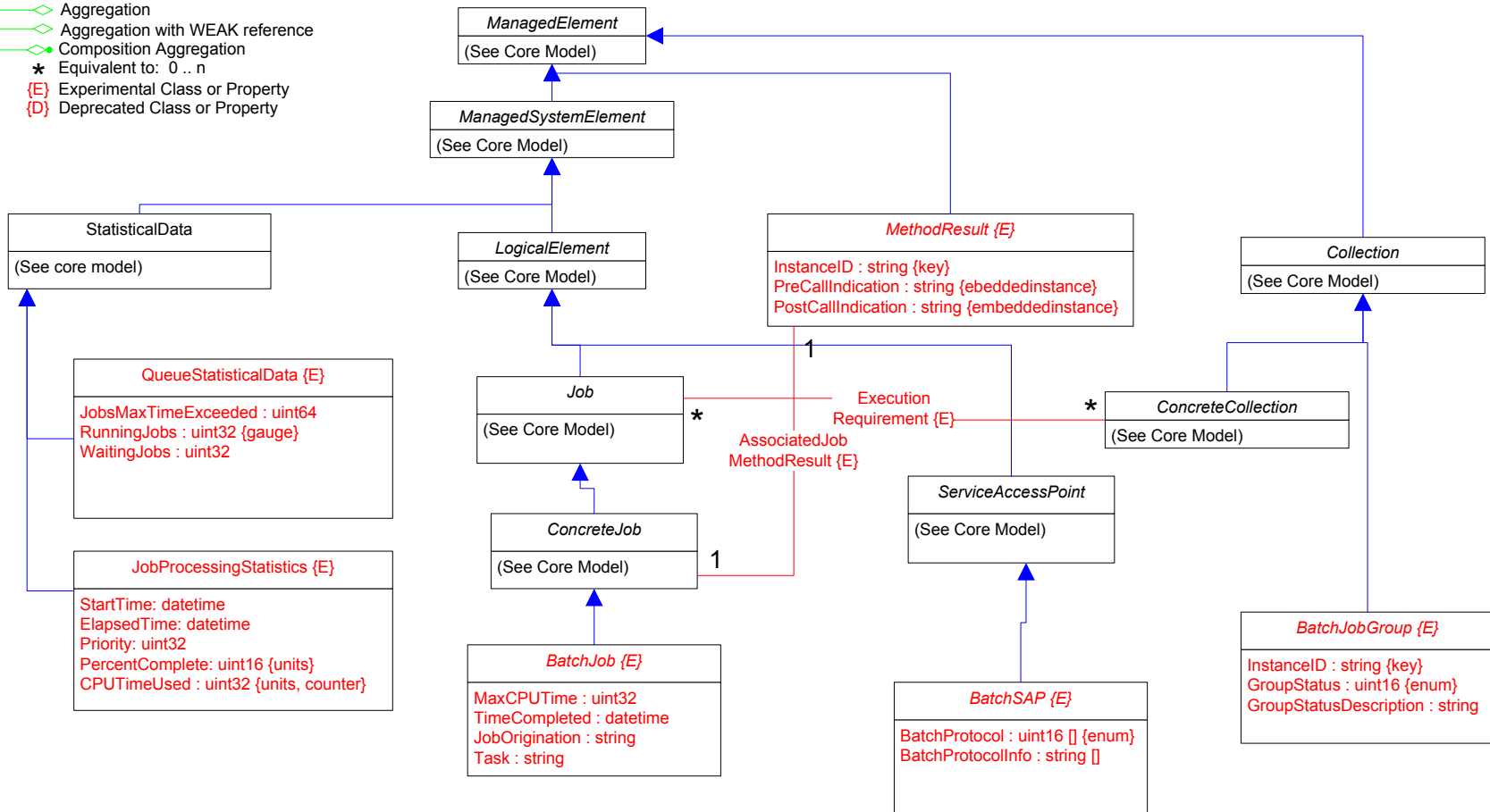

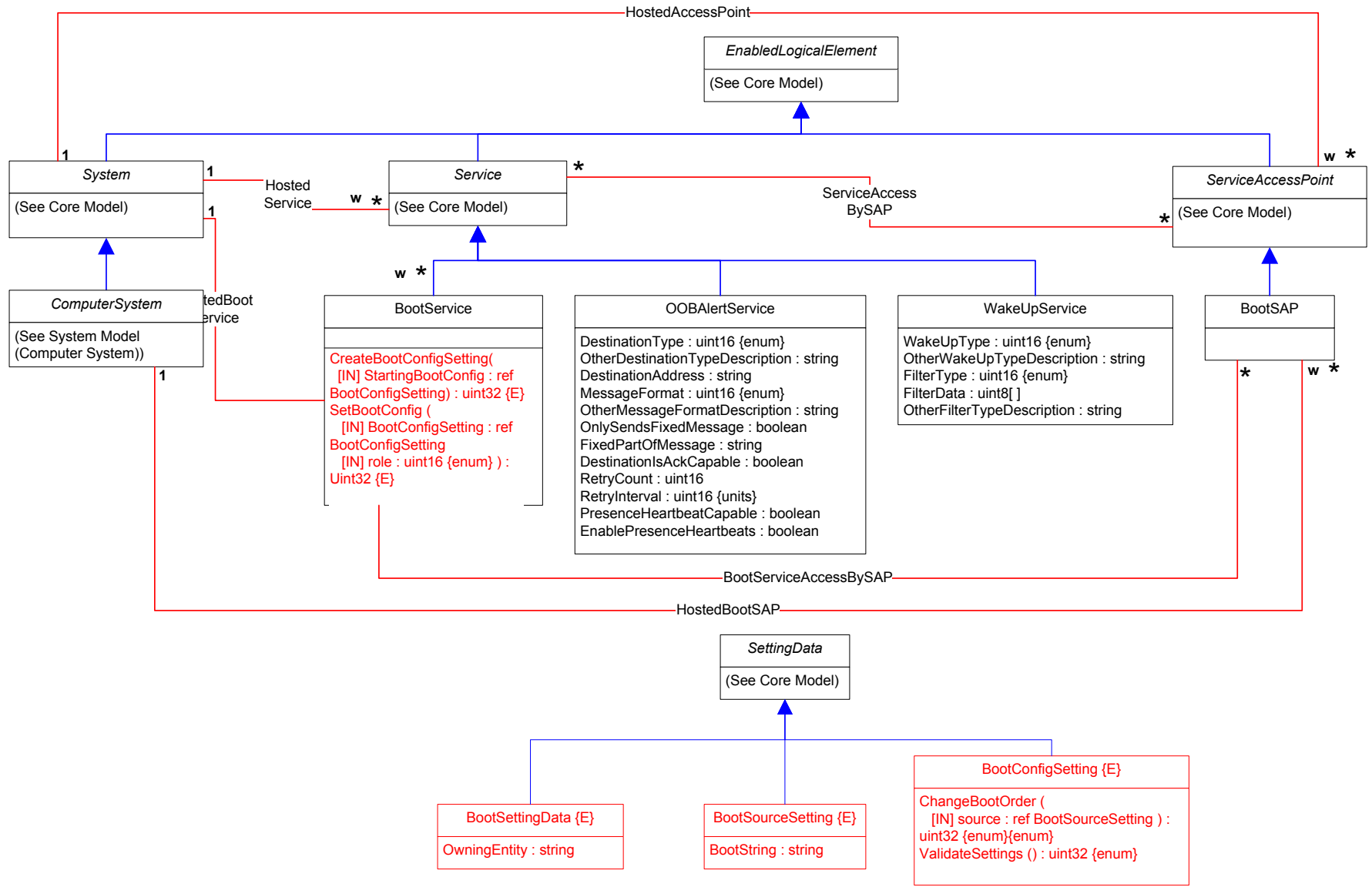
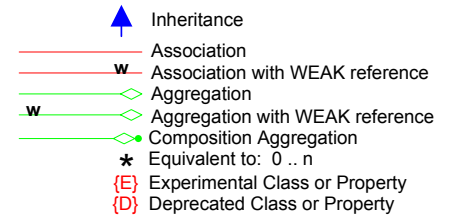

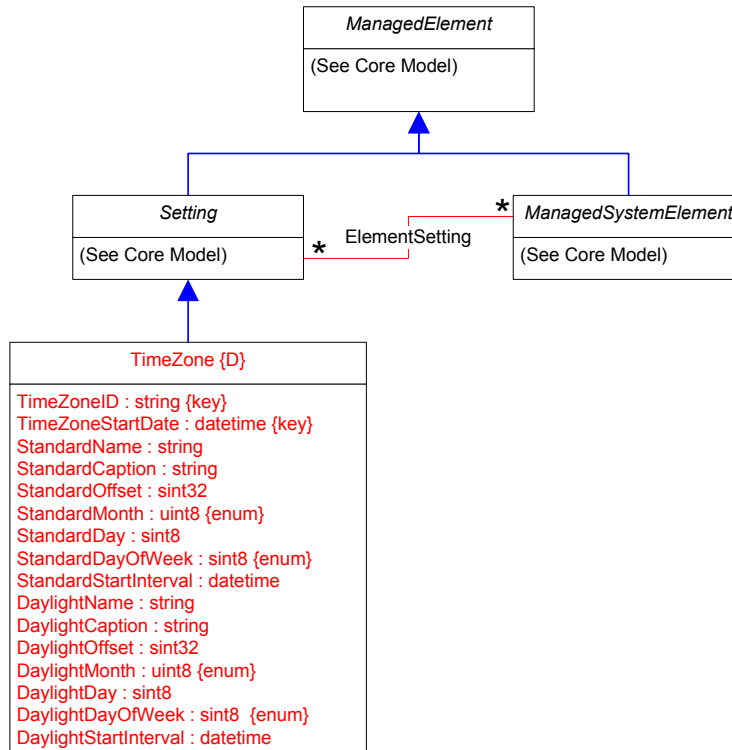
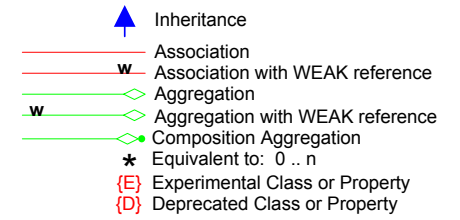

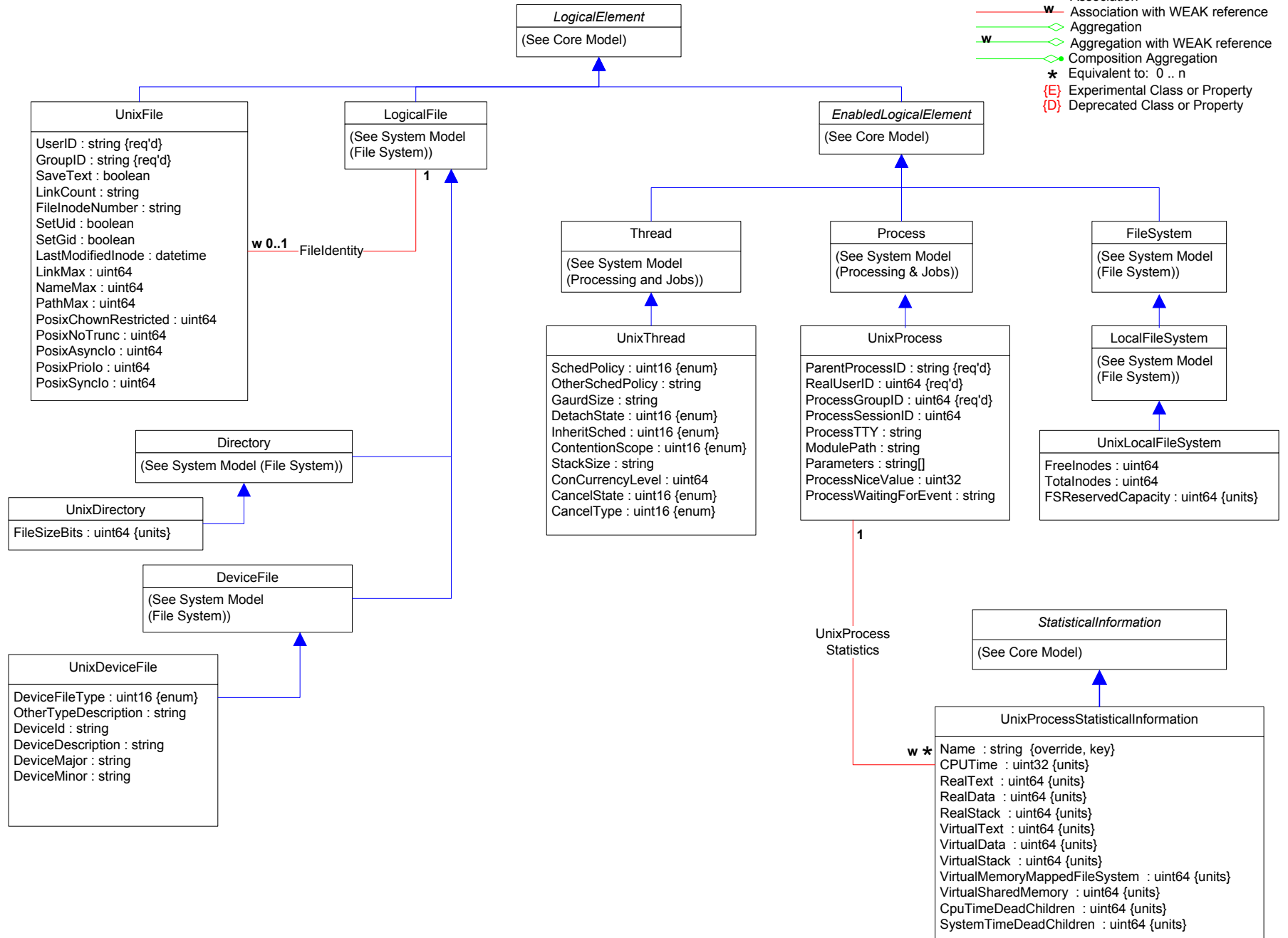
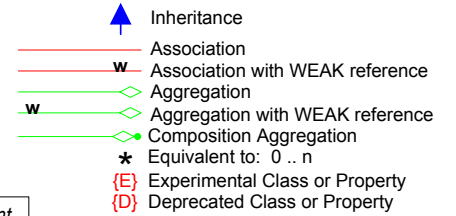

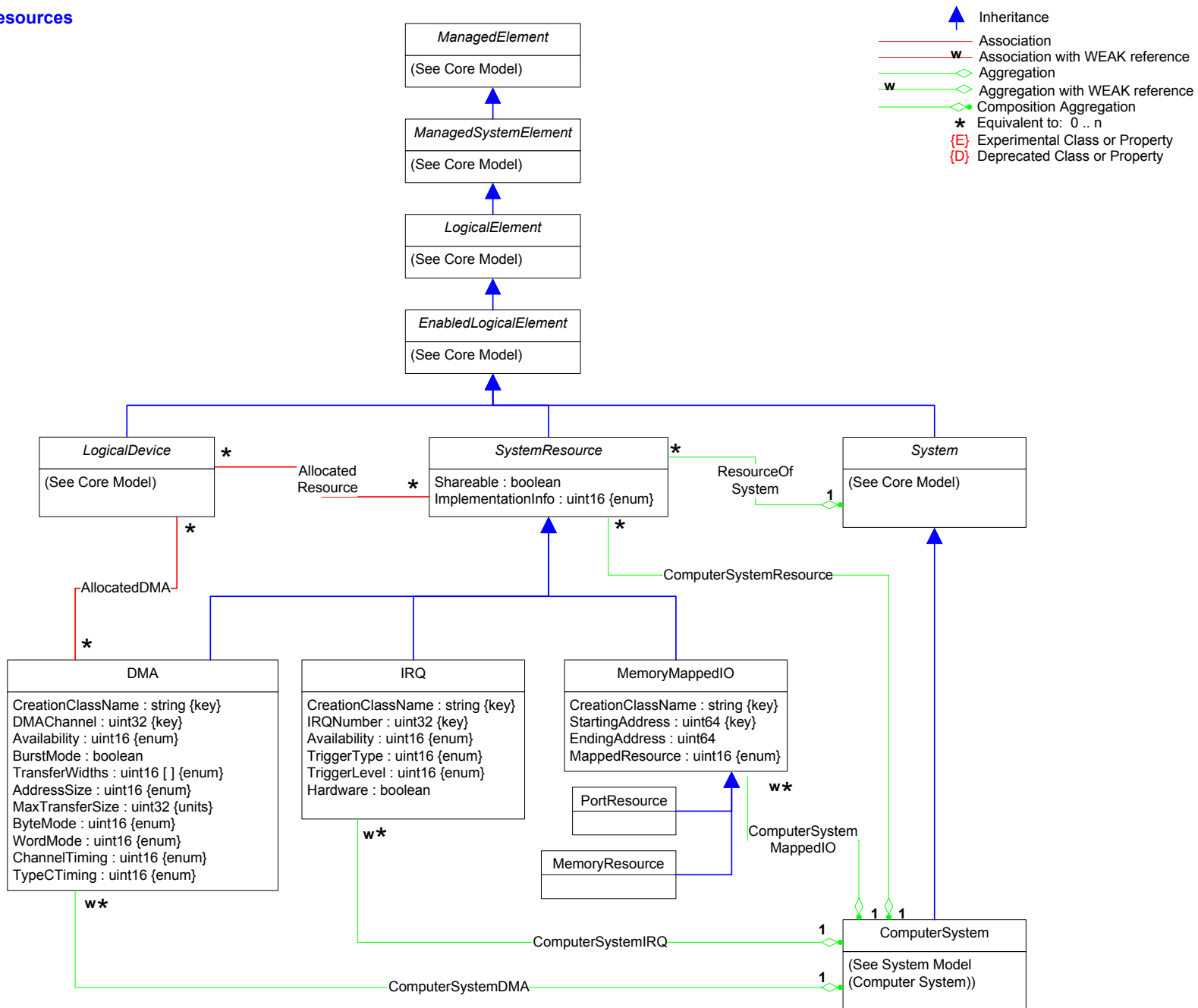

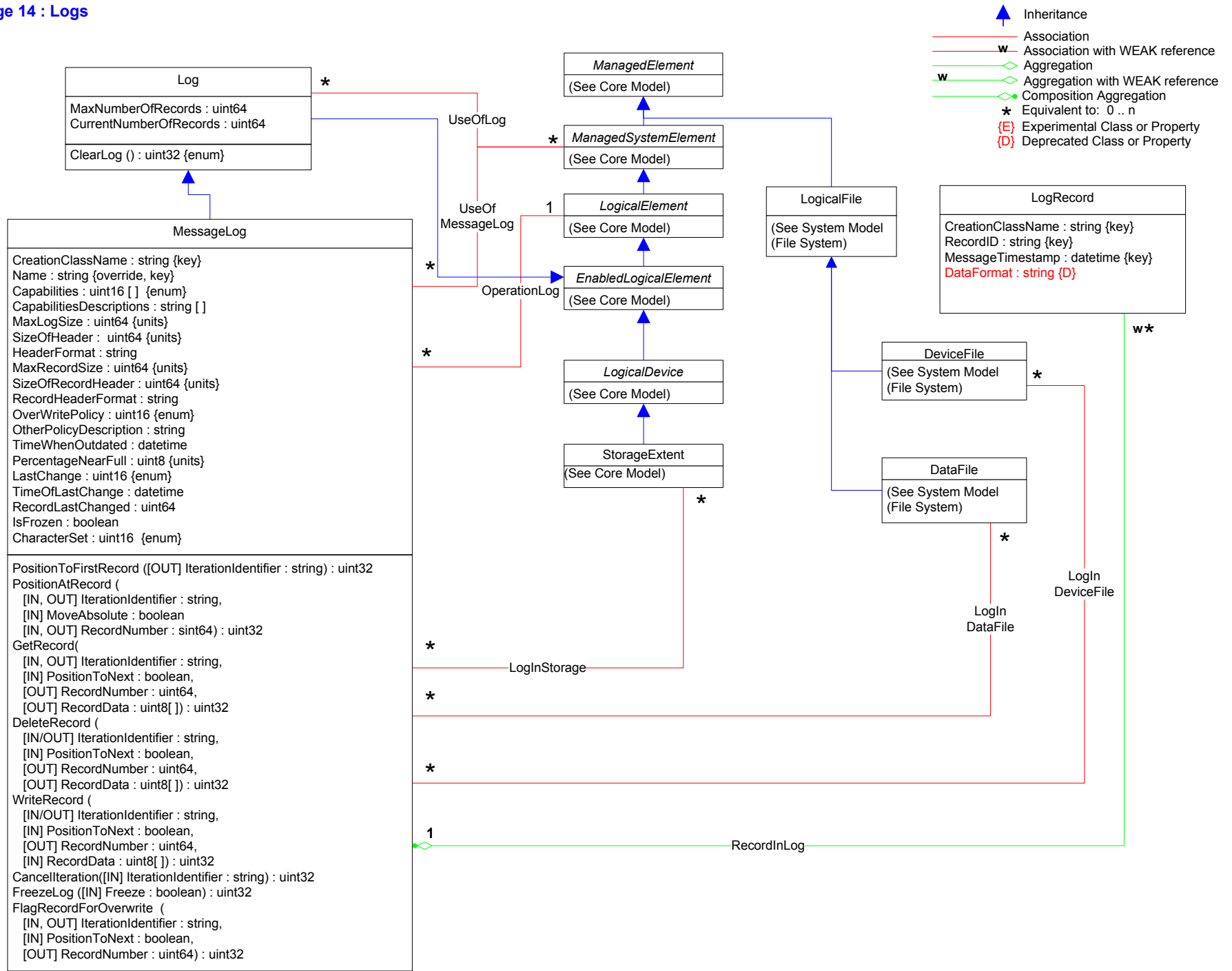

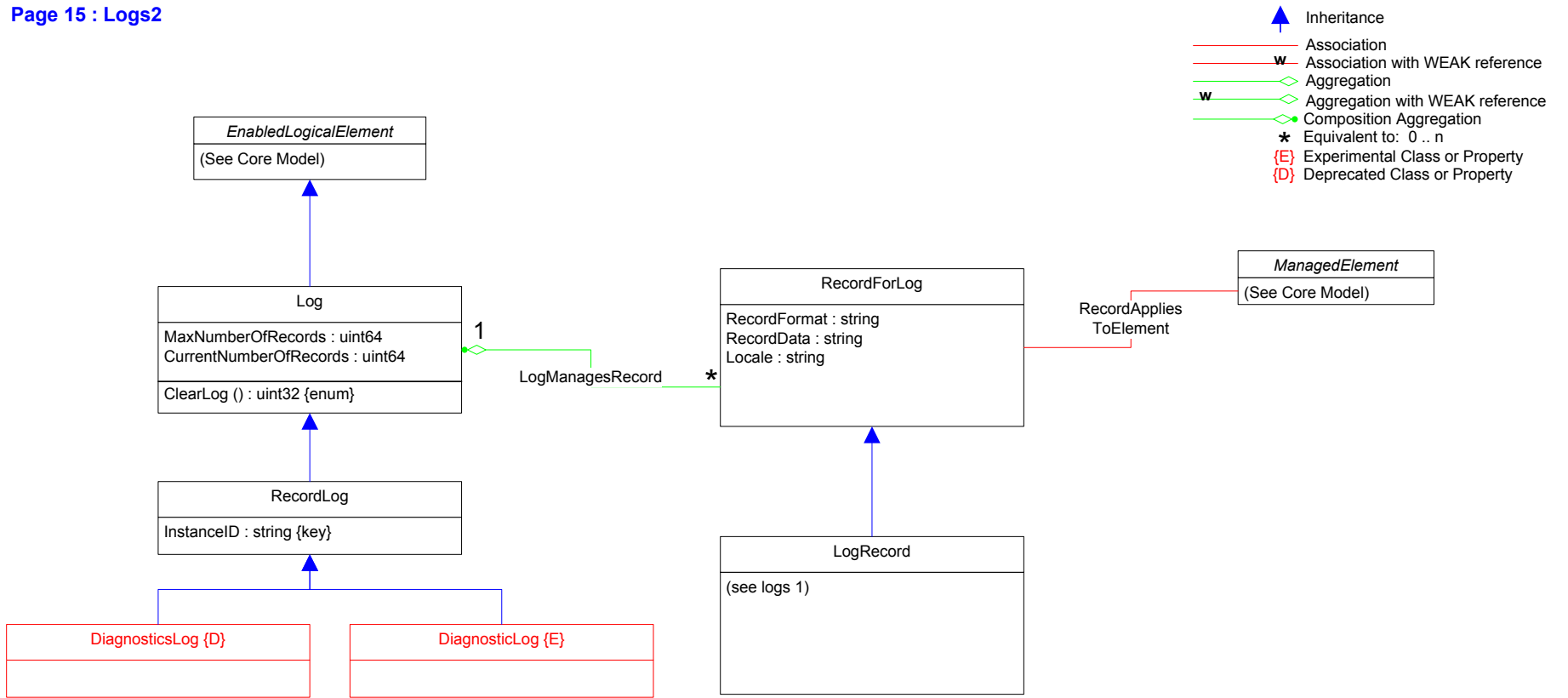

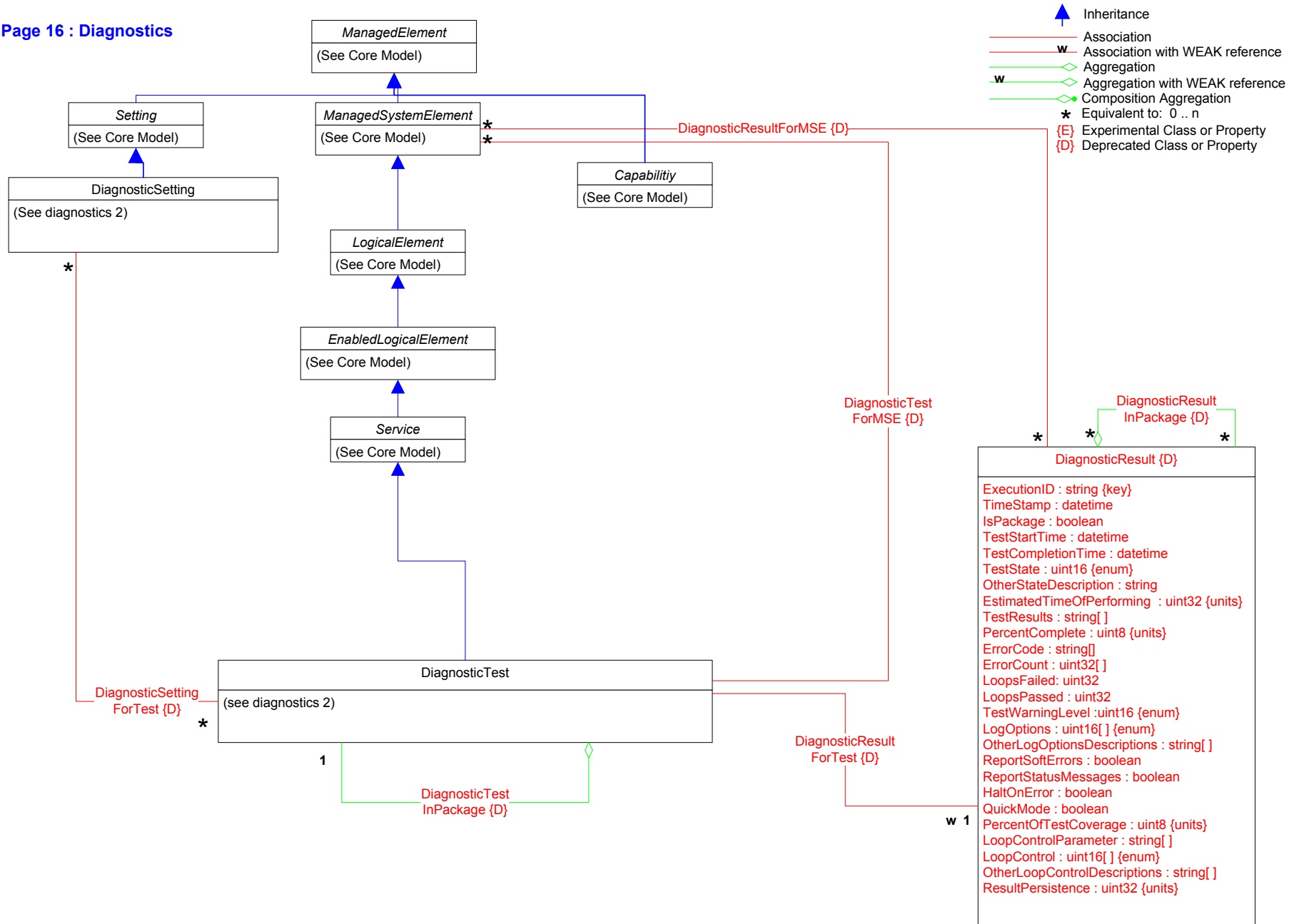

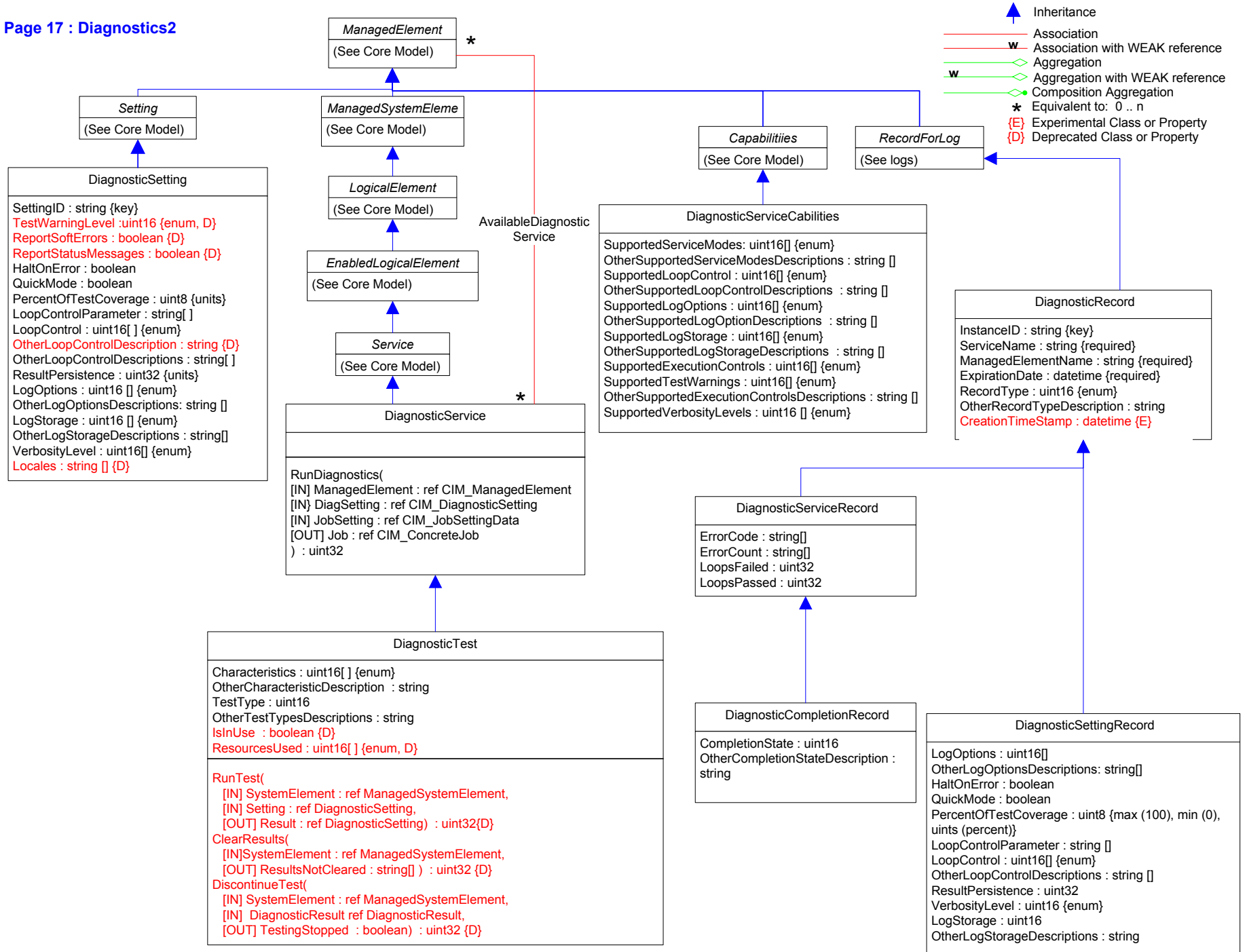

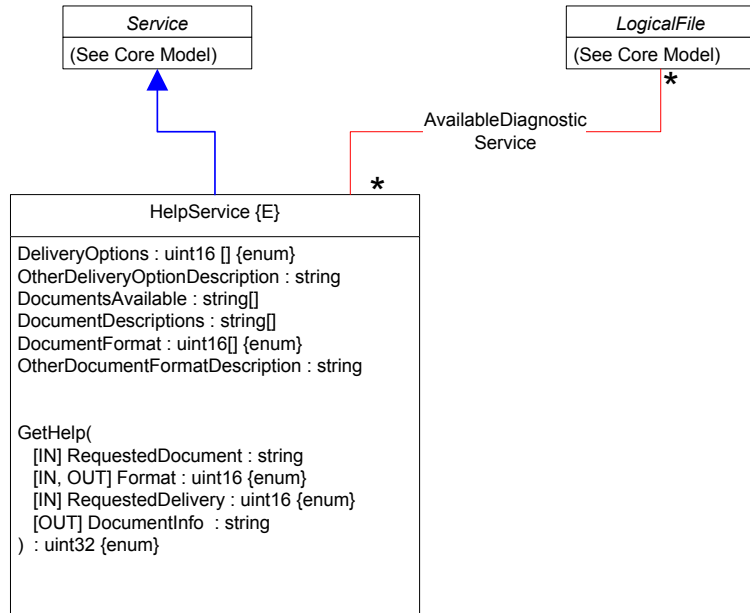

- Inheritance
- Association
- Association with WEAK reference
- Aggregation
- Aggregation with WEAK reference
- Composition Aggregation
- Equivalent to: 0 .. n
- Experimental Class or Property
- Deprecated Class or Property

Page 19 : Association Hierarchy

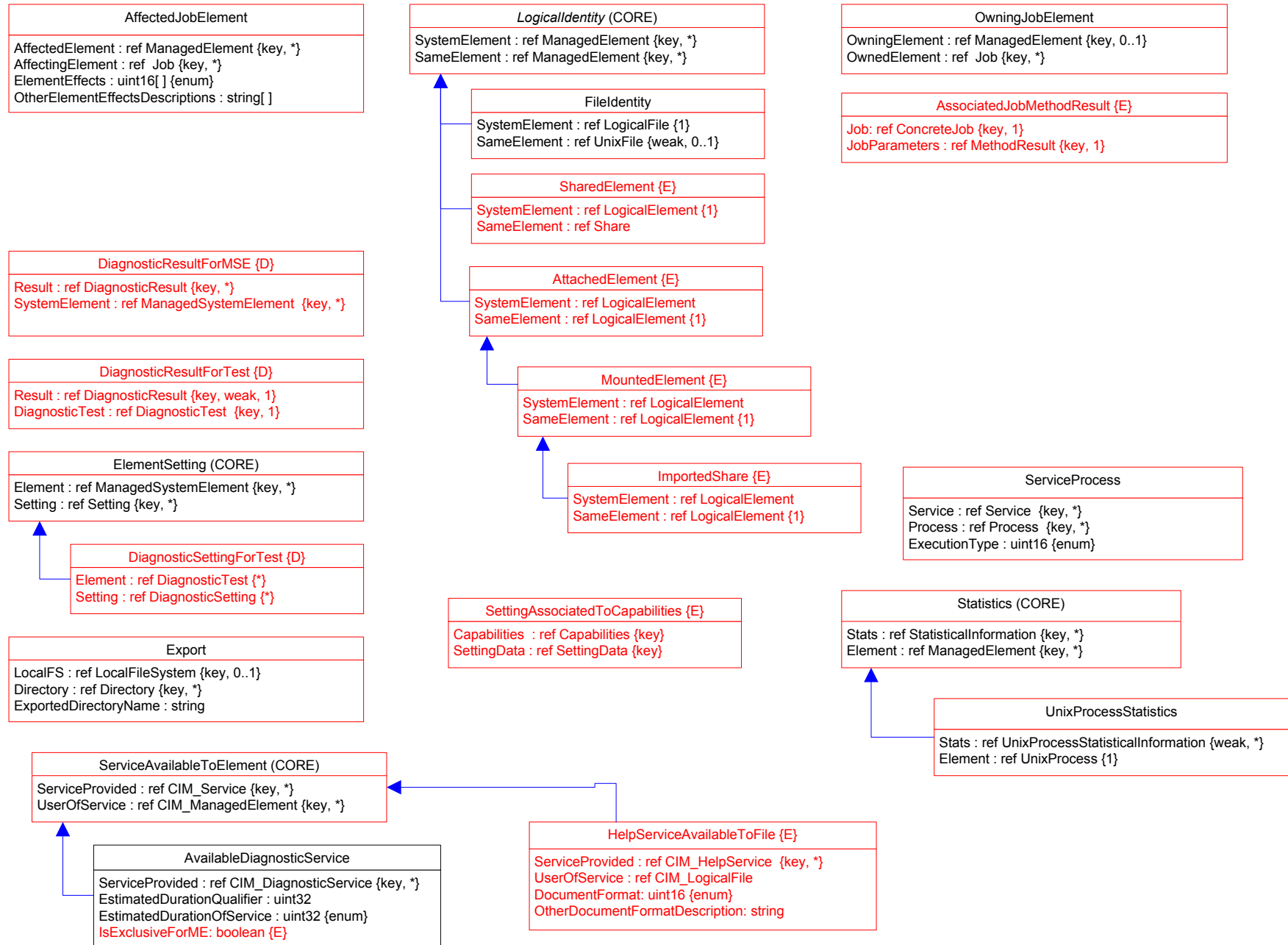

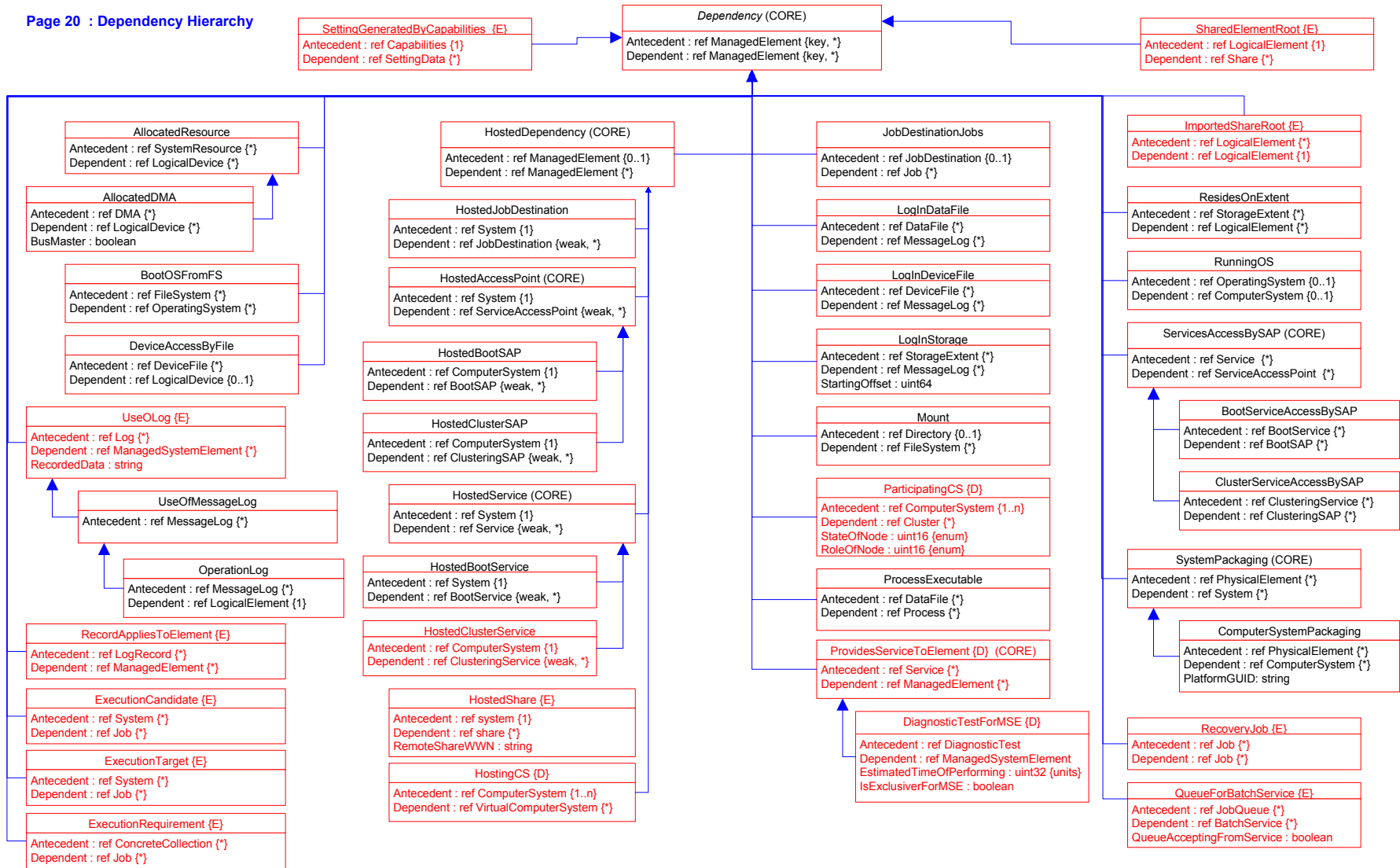

Page 21 : Aggregation Hierarchy

