

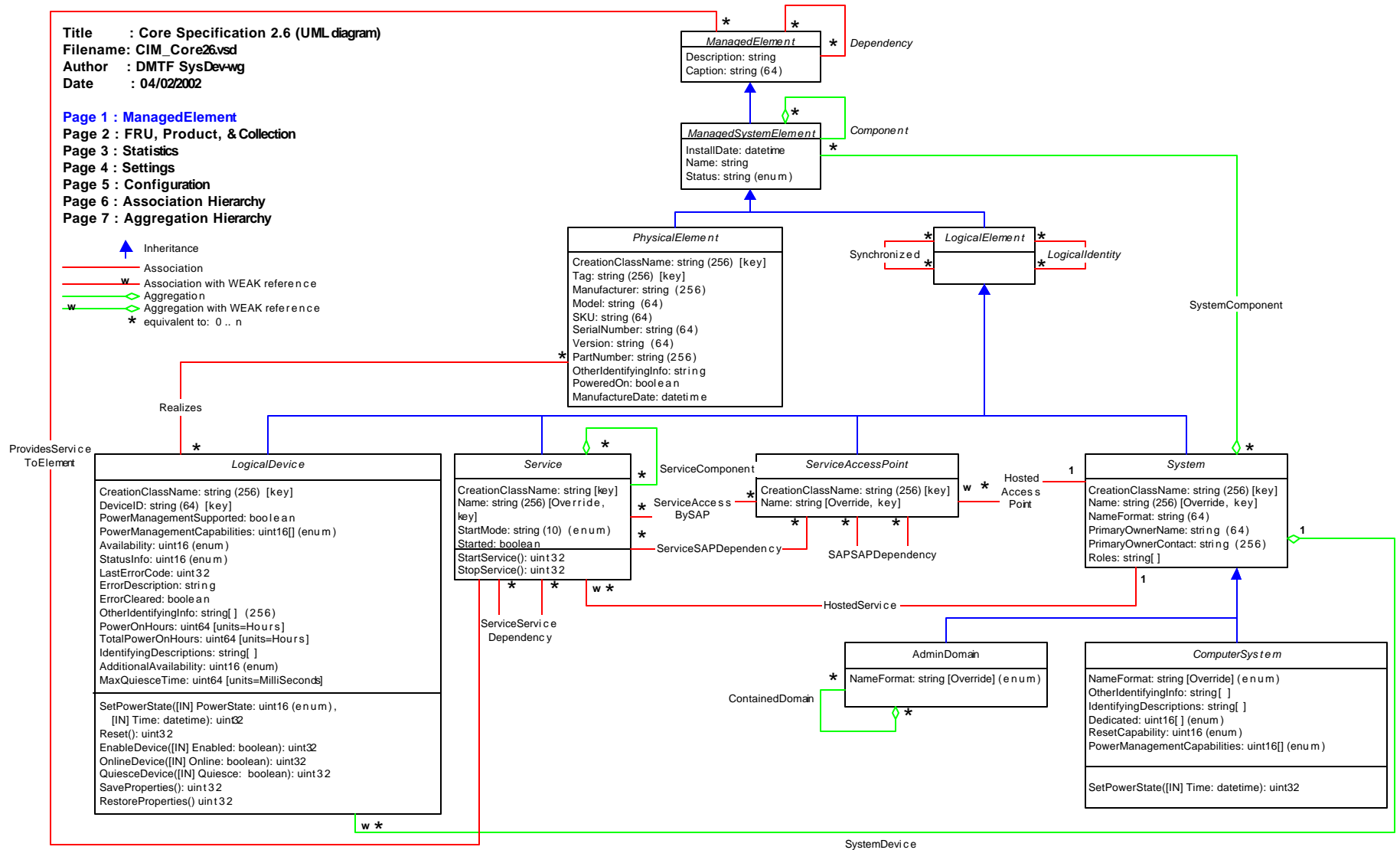





Title : Core Specification 2.6 (UML diagram)
 Filename: CIM_Core26vsd
 Author : DMTF SysDevwg
 Date : 04/02/2002

- Page 1 : ManagedElement
- Page 2 : FRU, Product, & Collection
- Page 3 : Statistics
- Page 4 : Settings
- Page 5 : Configuration
- Page 6 : Association Hierarchy
- Page 7 : Aggregation Hierarchy

- Inheritance
- Association
- Association with WEAK reference
- Aggregation
- Aggregation with WEAK reference
- equivalent to: 0 .. n



Page 2 : FRU, Product, & Collections

-  Inheritance
-  Association
-  Association with WEAK reference
-  Aggregation
-  Aggregation with WEAK reference
-  * equivalent to: 0..n

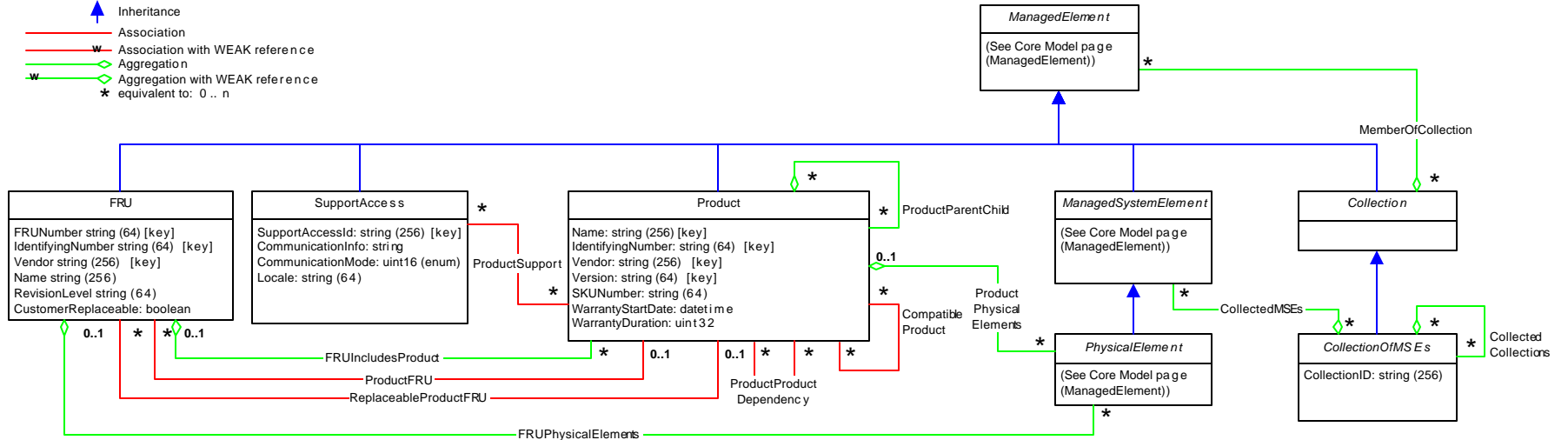





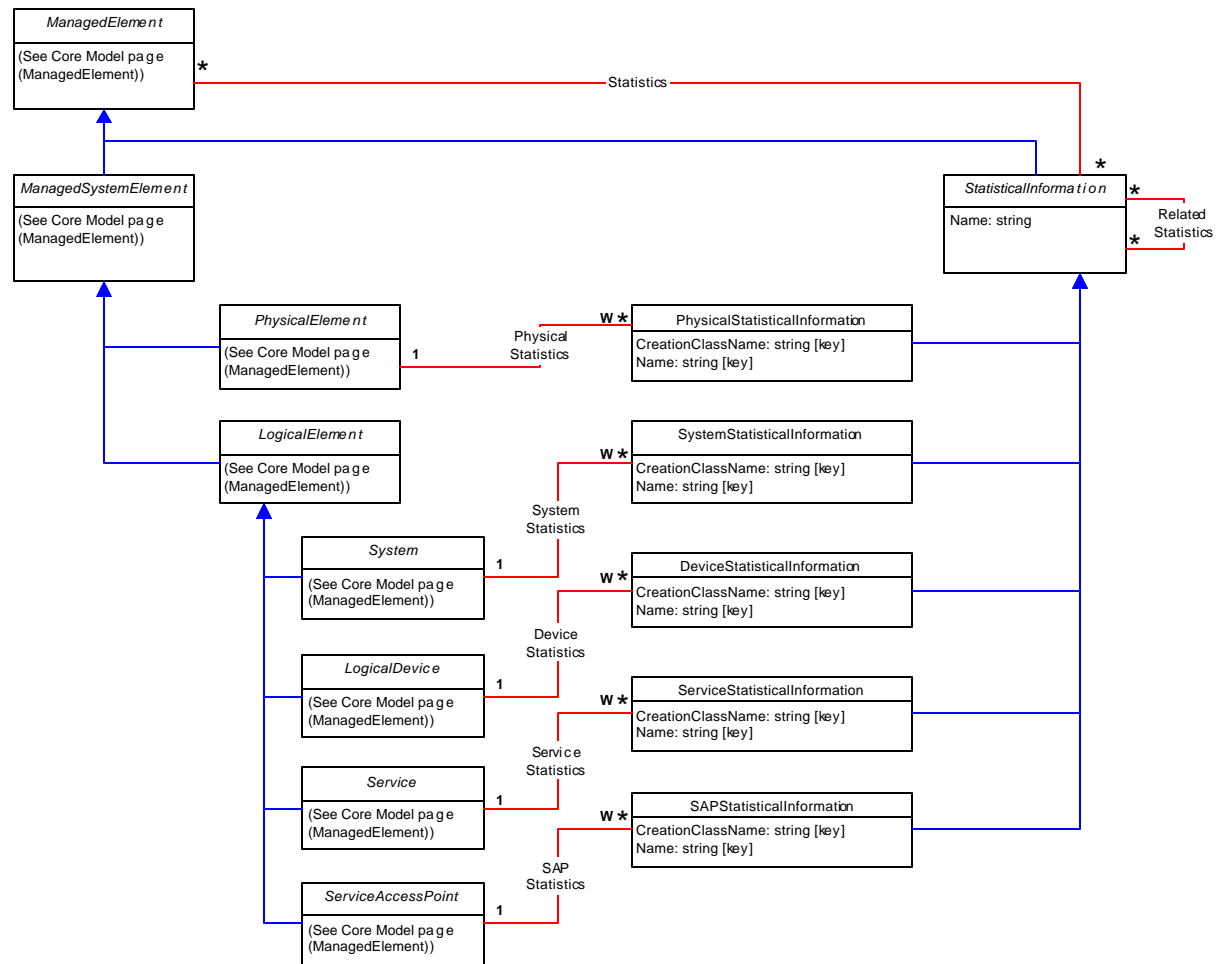

Page 3 : Statistics

- ↑ Inheritance
- Association
- w Association with WEAK reference
- ◇ Aggregation
- w◇ Aggregation with WEAK reference
- * equivalent to: 0 .. n







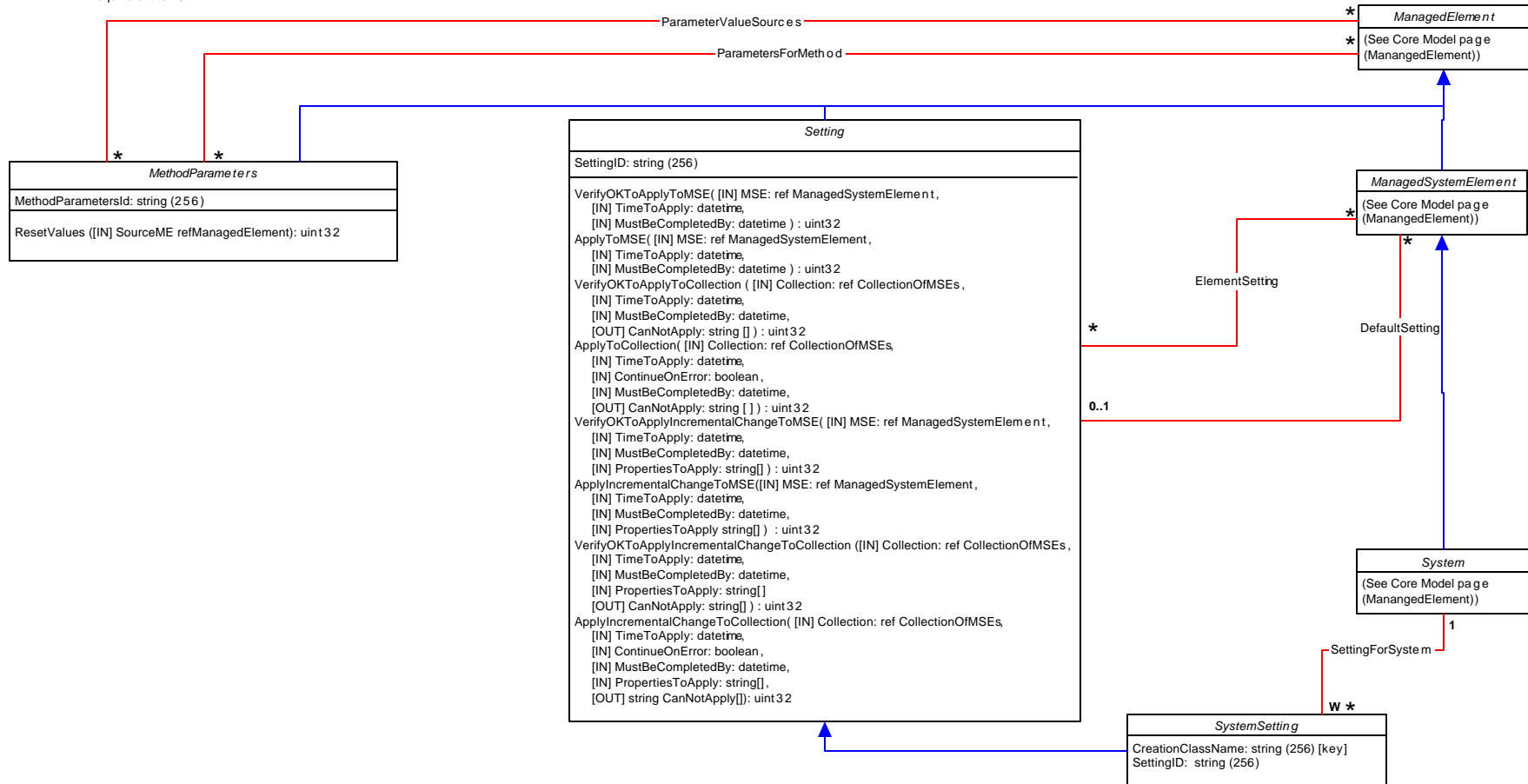

Page 4 : Settings

-  Inheritance
-  Association
-  Association with WEAK reference
-  Aggregation
-  Aggregation with WEAK reference
-  * equivalent to: 0..n



Page 5 : Configuration

-  Inheritance
-  Association
-  Association with WEAK reference
-  Aggregation
-  Aggregation with WEAK reference
-  * equivalent to: 0 .. n

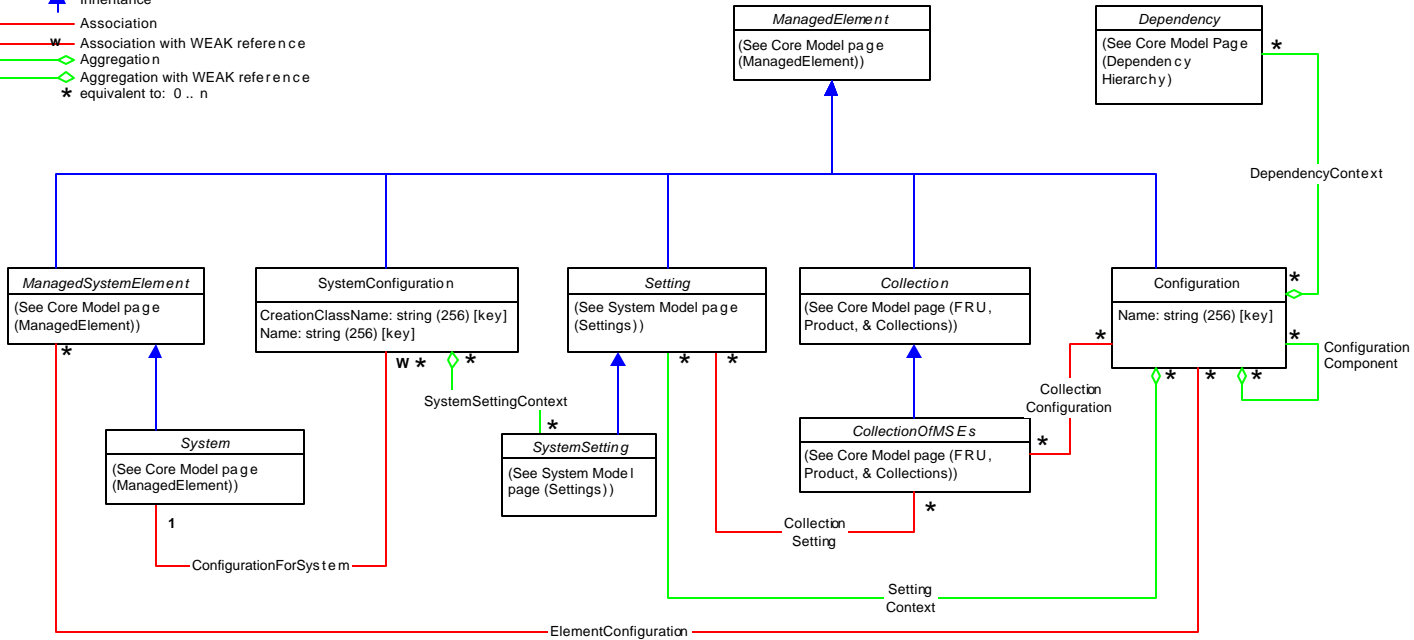

Page 6 : Association Hierarchy

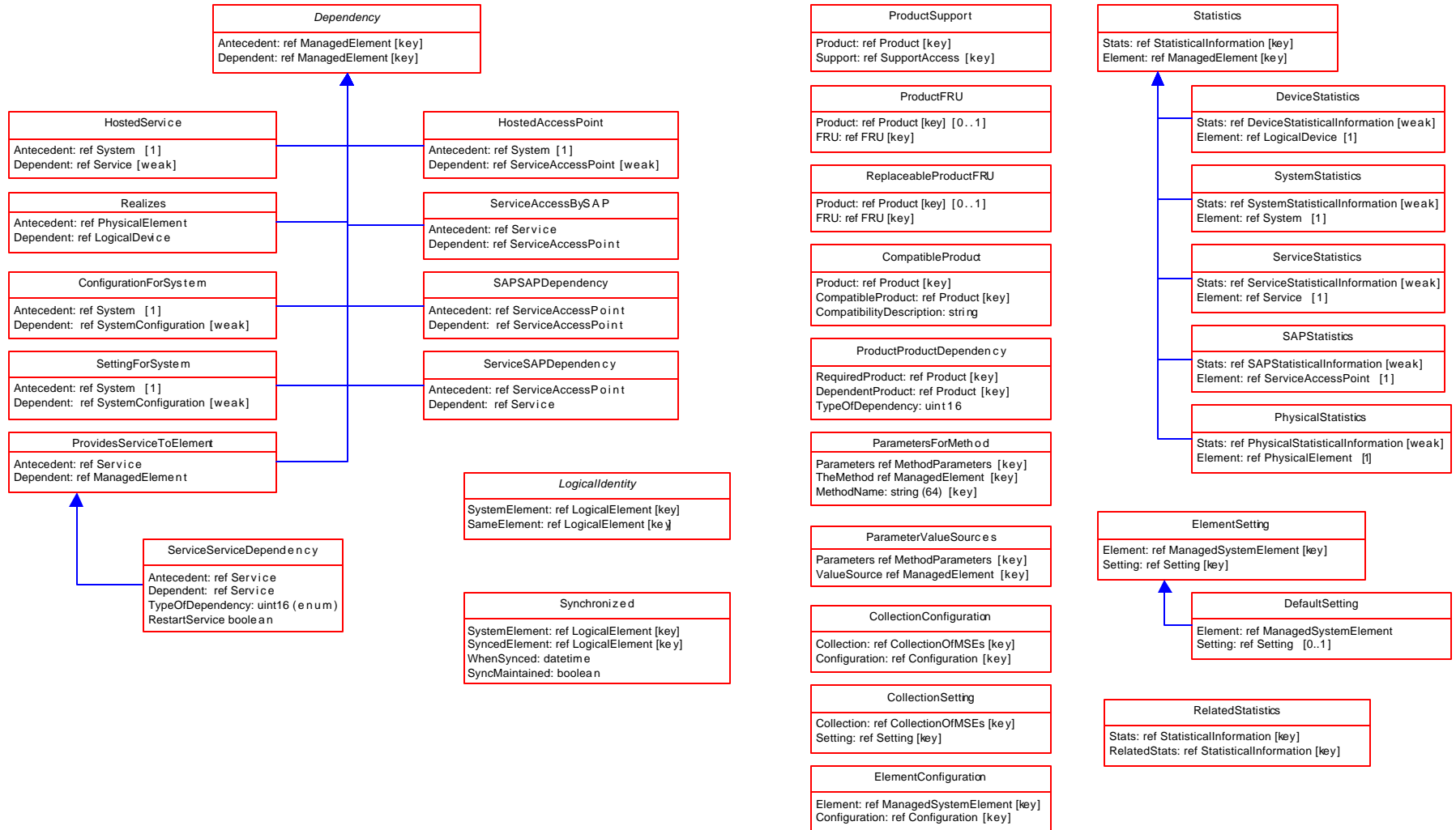

Page 7 : Aggregation Hierarchy

