



Managing NFV Infrastructure Using DMTF Standards

July 22, 2015

Hemal Shah

Senior VP and VP of Technology, DMTF
Technical Director/Distinguished Engineer, Broadcom Corporation

Agenda

- DMTF Background
 - Who is the DMTF?
 - DMTF Technical Committee
- DMTF Management Initiatives and Standards Overview
- Mapping DMTF Standards onto NFV Architecture
- ETSI-NFV and DMTF Alliance

Simple goals of this presentation/talk

- Provide an overview of DMTF technologies and standards
- Discuss applicability of DMTF standards to NFV architecture

Who is the DMTF?



DMTF Board Companies

More than 3,500 participants from well over 180 organizations crossing 43 countries



DMTF Leadership Companies

[Advanced Micro Devices](#)
[Arquimedes Automacao e Informatica Ltda](#)
[Brocade Communications Systems](#)
[China Academy of Telecommunication Research, MIIT](#)
[China Electronics Standardization Institute](#)
[Citrix Systems Inc.](#)

[Daten Tecnologia Ltda](#)
[EMC](#)
[Fujitsu](#)
[Huawei](#)
[Inspur](#)
[Mellanox Technologies](#)
[MIMOS Berhad](#)

[NetIQ Corporation](#)
[Oracle](#)
[Positivo Informática SA / Positivo Informática da Amazônia LTDA](#)
[Supermicro](#)
[WBEM Solutions](#)
[ZTE Corporation](#)

DMTF Background

- Distributed Management Task Force: Formed in 1992 with a focus on desktop management
- Evolved from desktop management to web based enterprise management



1994: Desktop Management Interface (DMI)
1996: Common Information Model (CIM)
1997: Directory Enabled Networks (DEN)
1998: Web Based Enterprise Management (WBEM)
1999: System Management BIOS (SMBIOS)
2001: Alerting Standards Format (ASF)



2005: Common Diagnostics Model (CDM)
2005: System Management Architecture for Server Hardware (SMASH)
2006: Desktop and Mobile Architecture for System Hardware (DASH)
2007: Platform Management Components Intercommunication (PMCI): NC-SI, MCTP, PLDM
2008: Open Virtualization Format (OVF), Virtualization Management (VMAN) & WS-Management
2009: Configuration Management Database Format (CMDBf)

2010: Cloud Initiative/Incubator
2011: Cloud Audit Data Format (CADF)
2012: Cloud Infrastructure Management Interface (CIMI), Software Licensing Model (SLM), MRP, VPP
2013: Software Defined Data Center (SDDC), Network Management (NETMAN)
2014: Redfish for Scalable Platform Management

- Evolving work includes
 - DMTF Management Initiatives, Protocols (Web Services), Profile Development, Schema Evolution, Internal Interfaces, Operations, Messages, Registries, Federation & more.



TC Organization

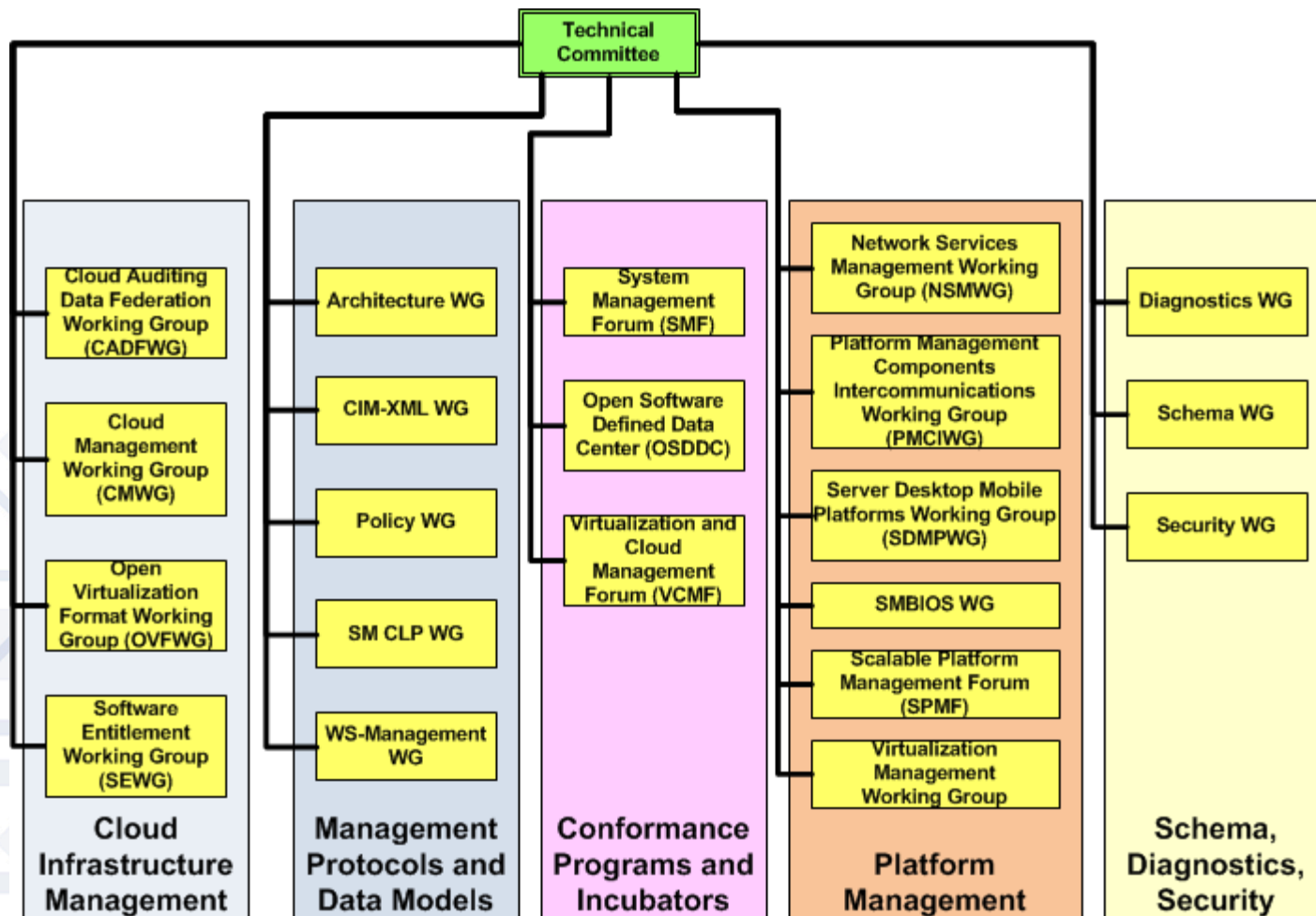



Recent DMTF Accomplishments

- Continued wide acceptance of DMTF standards in industry, Examples:
 - 2 Billion+ platforms with SMBIOS implementation
 - CIM Object Manager (CIMOM) shipping in every OS/hypervisor distribution
 - 170+ certified products in DASH 1.0 conformance registry
- Increased adoption of DMTF standards in open source, Examples:
 - OpenStack ceilometer - CADF
 - Open Linux Management Infrastructure (OpenLMI) - SMASH/DASH/CIM
 - Open Management Interface (OMI) and Pegasus - CIM/WBEM
- Expansion of scope continues in the DMTF
 - REST based APIs (Redfish), OSDDC, ETSI-NFV mapping, Network management....
- 45 standards and 32 work-in-progress published in 2014
- International acceptance of DMTF standards via ISO and ANSI adoption
 - 1 new ISO standard in 2014 (bringing **total** to **5 ISO** standards)
 - 1 in-progress ANSI standard in 2014 (**8** already published **ANSI standards**)
- Four CIM Schema Releases – 2.40, 2.41, 2.42, and 2.43

DMTF Management Technologies

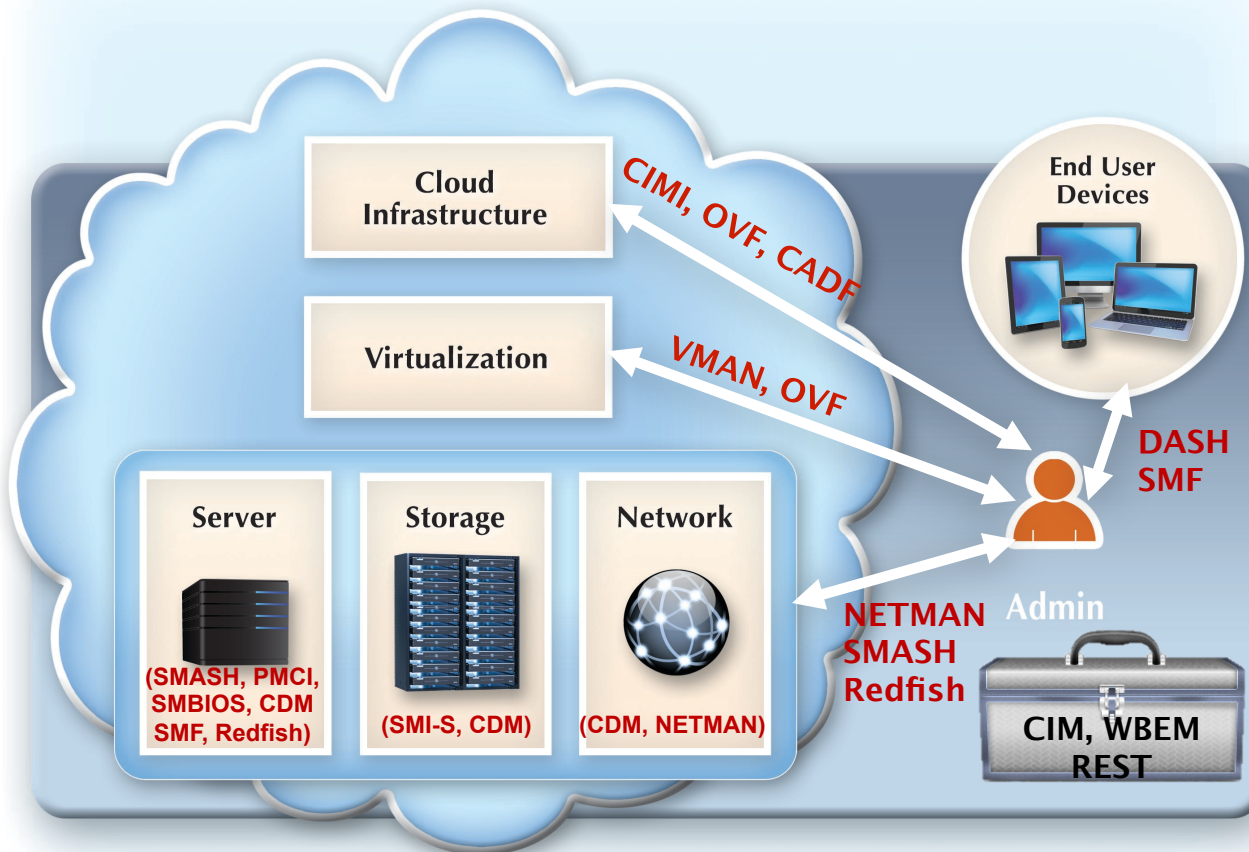

- ### Infrastructure Management
- Cloud
 - Virtualization
 - Data Center

- ### Platform Management
- Server & Network
 - Storage (SNIA)
 - Desktop & Mobile

- ### Services Management
- Network services
 - Software Entitlement
 - Security & audit

- ### Protocols & Data Models
- WS-Man/CIM-XML
 - REST/JSON/OData
 - CIM & Diagnostics
 - PLDM/MCTP



ETSI NFV Architecture (Phase 1)

NFV Management and Orchestration

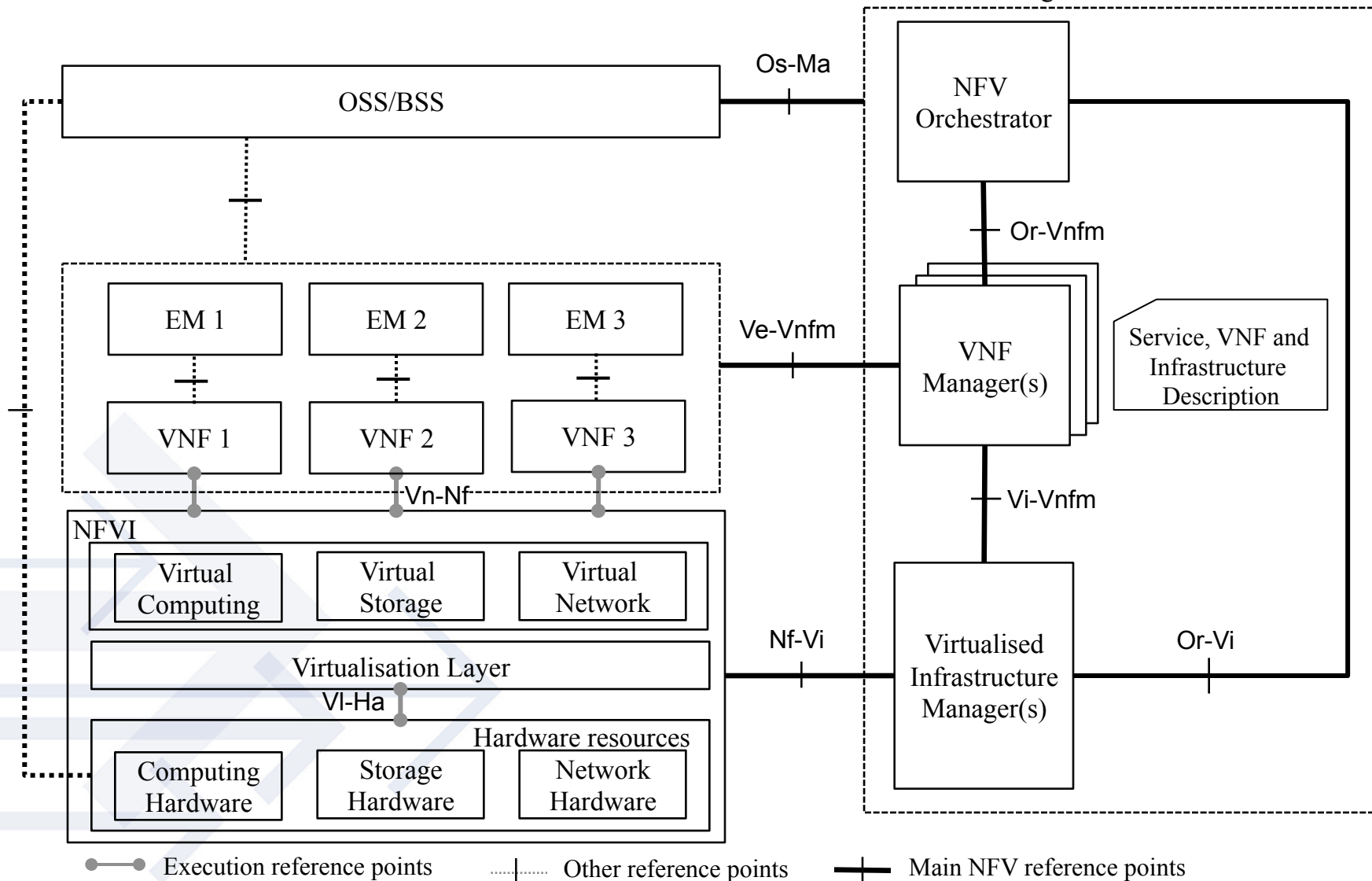

DMTF Technologies for NFV Phase 1

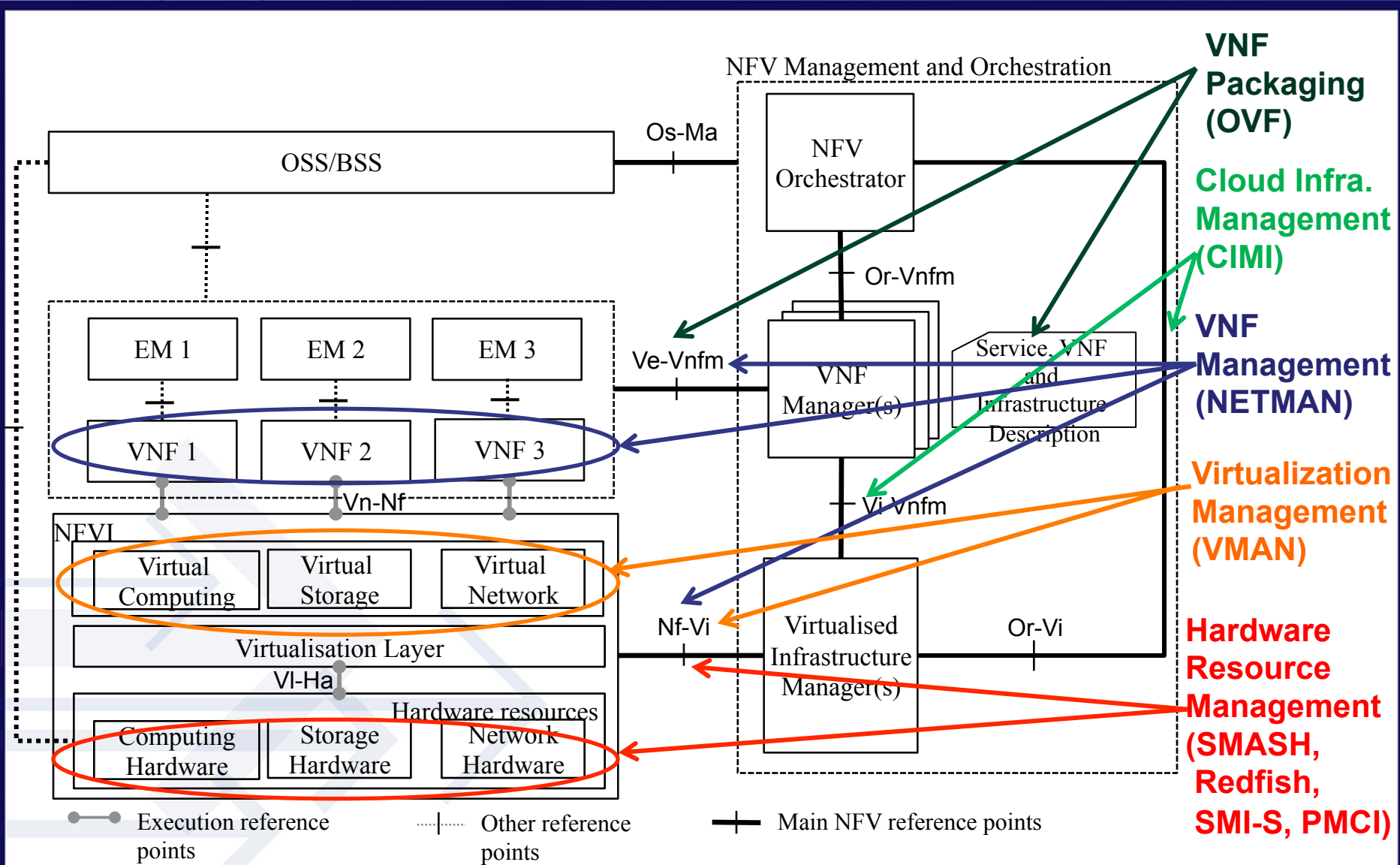



Cloud Infrastructure Management Interface (CIMI)

What is it?

- A Management interface between the cloud service consumer / provider
- Includes a cloud resource model and a REST/HTTP binding to the model

What problems does CIMI solve?

- Cloud customers are using **various interfaces** to manage clouds:
 - EC2, OpenStack Nova, Cloud Stack, Open Nebula, vendor specific
- Each API **involves work to develop, test and maintain**
 - Little to no stability, versioning support, or backward compatibility
- APIs are **under control of specific vendors**, not open standards
- Open Source projects (CloudStack, OpenStack, Eucalyptus) only interoperate if everybody is **using the same code** – no winners here
- Customers need multiple clouds to balance risk and so they must either use only clouds with the same code, or **write multiple adapters** to each cloud

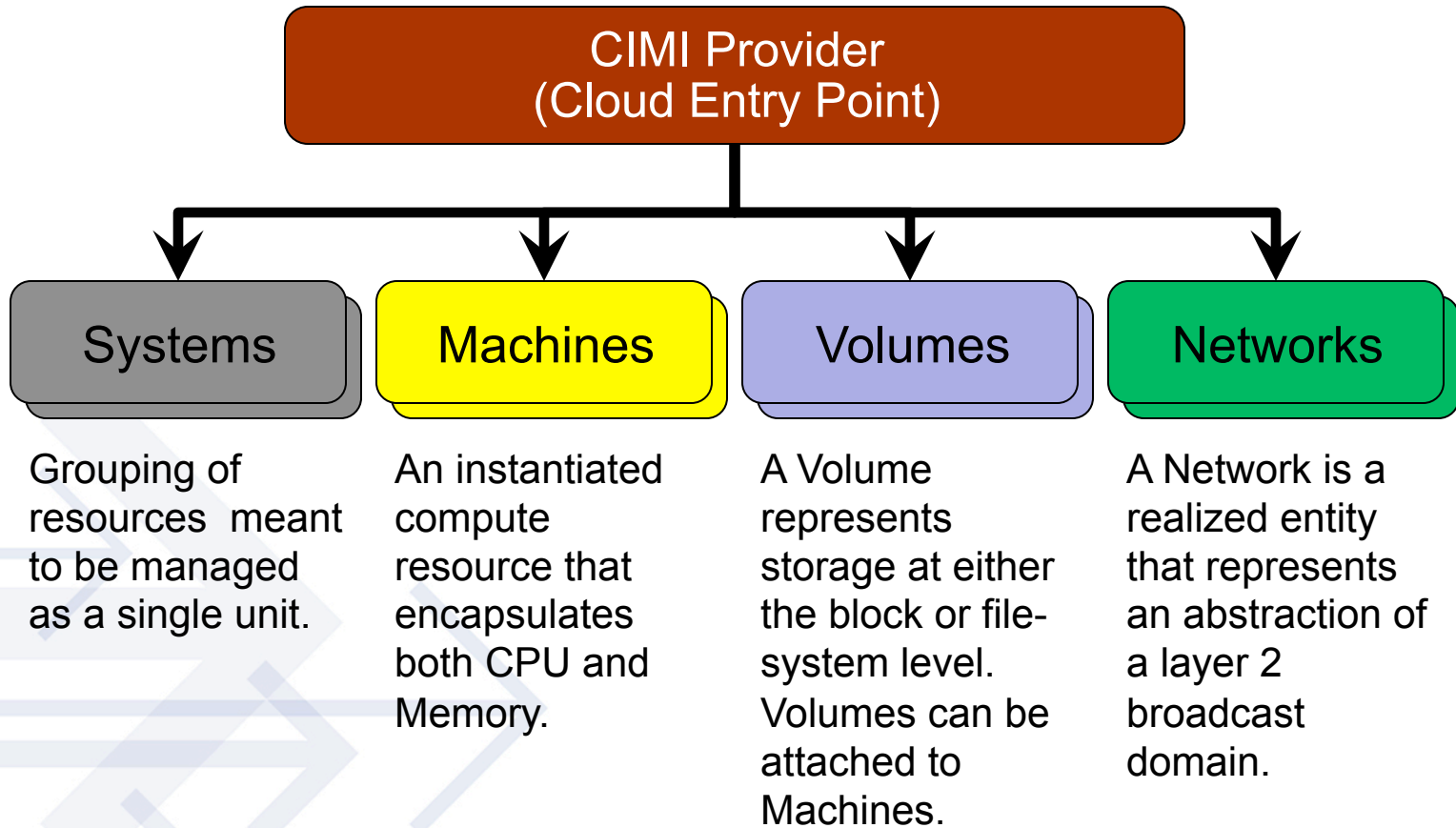



- A **distribution format** for virtual appliances
- Provides a complete description of a VM or multi-VMs in XML

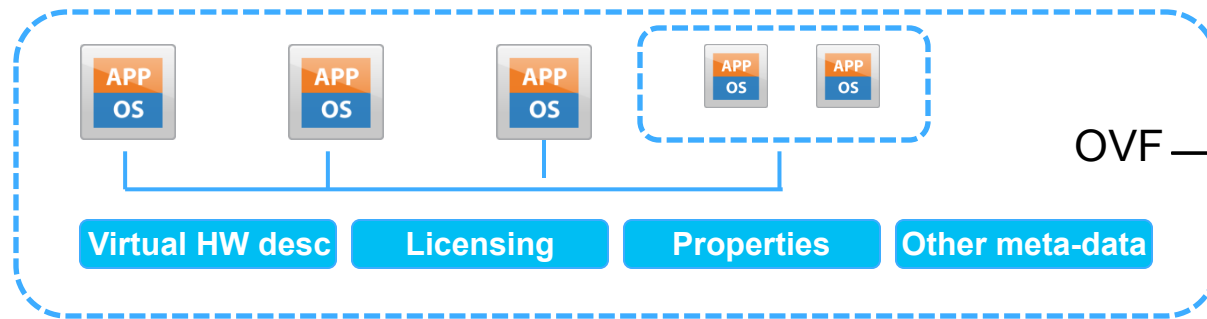

- Vendor and platform independent: Interoperable across platforms
- Extensible: Facilitate value-added features by DMTF or 3rd parties
- DMTF specifications
 - Version 1.1 - Jan 2010 (Virtual machines, Product Information, Licensing, hardware requirements, Deployment Options, Resource Requirements...)
 - Version 2.0 – Dec 2012 (Network Port Profiles, Scaling, placement policies, Encryption, Disk sharing, device boot order, advanced data transfer to guest...)
 - Version 2.1 – Dec 2013 (Activation Process, Meta data, Network Policy Service...)
 - ANSI/INCITS 469-2010 - Sept 2010 (national standard)
 - ISO/IEC 17203 - August 2011 (international standard)



OVF and CIMI

CIMI Using OVF Descriptor

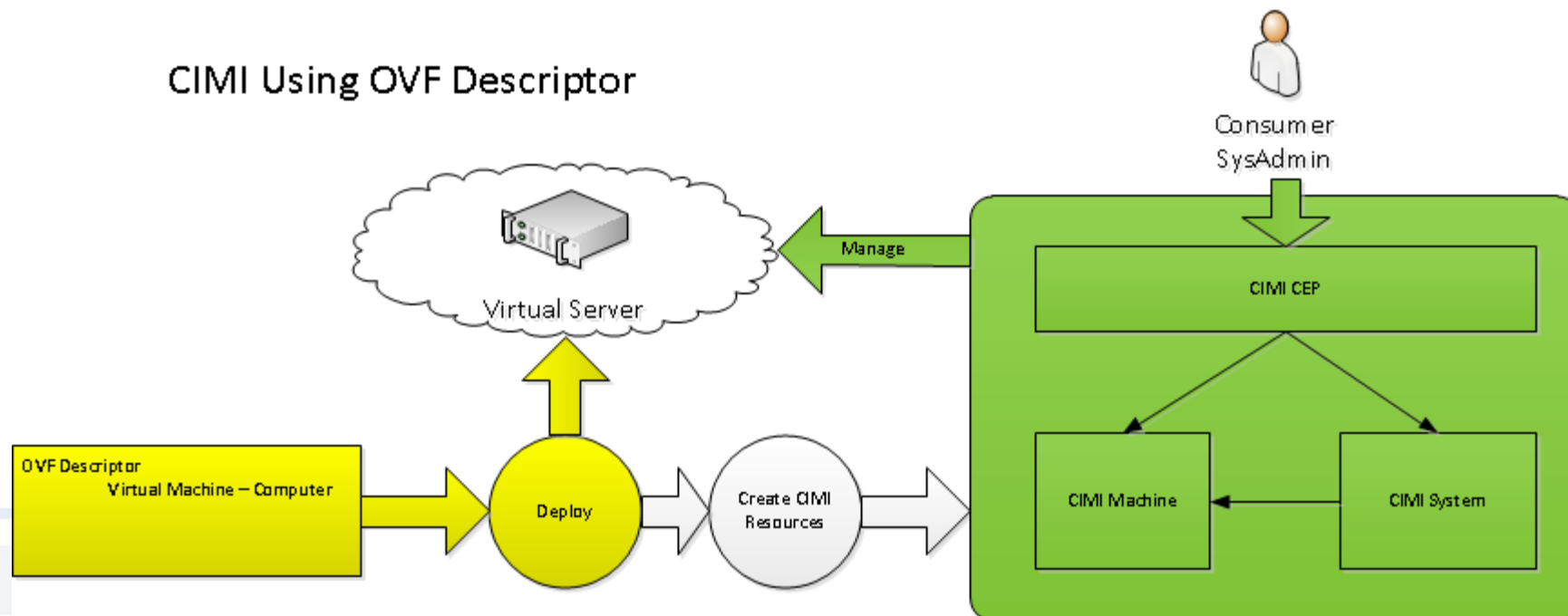

Why NETMAN?

- Existing and emerging network management standards still do not attempt to integrate across server, virtualization and cloud platforms
 - Narrowly focused on the individual domains (compute, network, storage)
 - Customer facing service management still requires expensive integration between various individually standard-compliant systems
- Rapid development of cloud, virtualization and software defined networks magnified the management challenges for service providers
 - Without seamless network management the consumers will not be able to fully benefit from the dynamic, cost-effective and fault tolerant services
- The goal of the DMTF Network Management (**NETMAN**) Initiative is to develop and promote the network management standards that span across these technology domains



Network Management Profiles Architecture

Network entities (resources and services) abstraction, virtualization and management

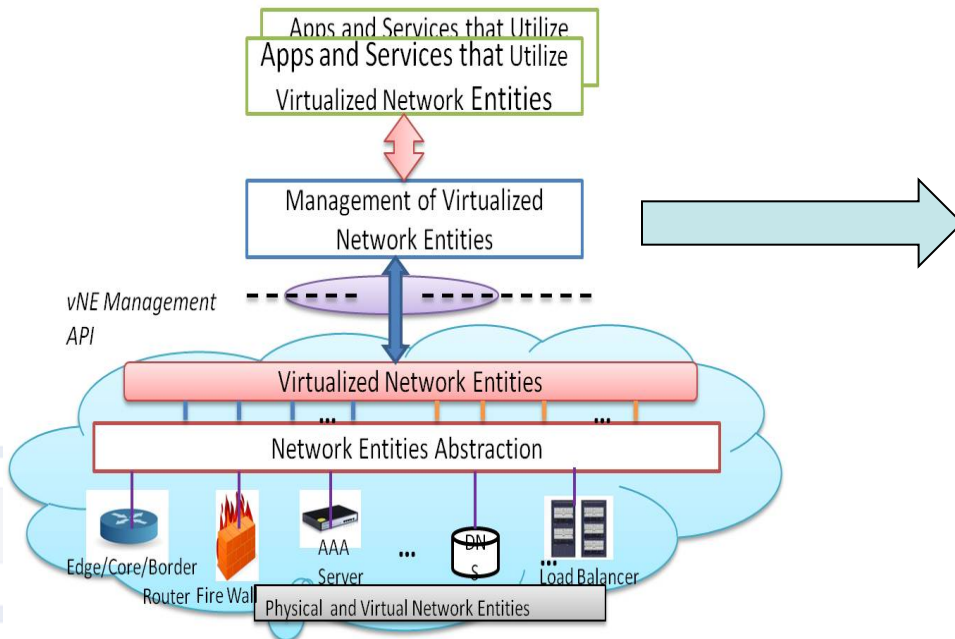

Leverage protocols, data models, infrastructure created for managing

- **Server**
- **Storage (SNIA)**
- **Desktop & Mobile**
- **Virtualization**

to perform

- **Network Management**
- **And Network Policy Management**

Thus

Unify compute, storage, and network management domains

Virtualization Management (VMAN)



- Addresses the management lifecycle of a virtual environment
- VMAN's CIM profiles standardize many aspects of the operational management of a heterogeneous virtualized environment
 - Supports creation, modification, deletion and inventory of virtual resources
 - Enable mapping of virtual resources to underlying resources
 - VMAN has been adopted and published by the American National Standard Institute (ANSI) International Committee for Information Technology Standards (INCITS) as INCITS 483-2012.

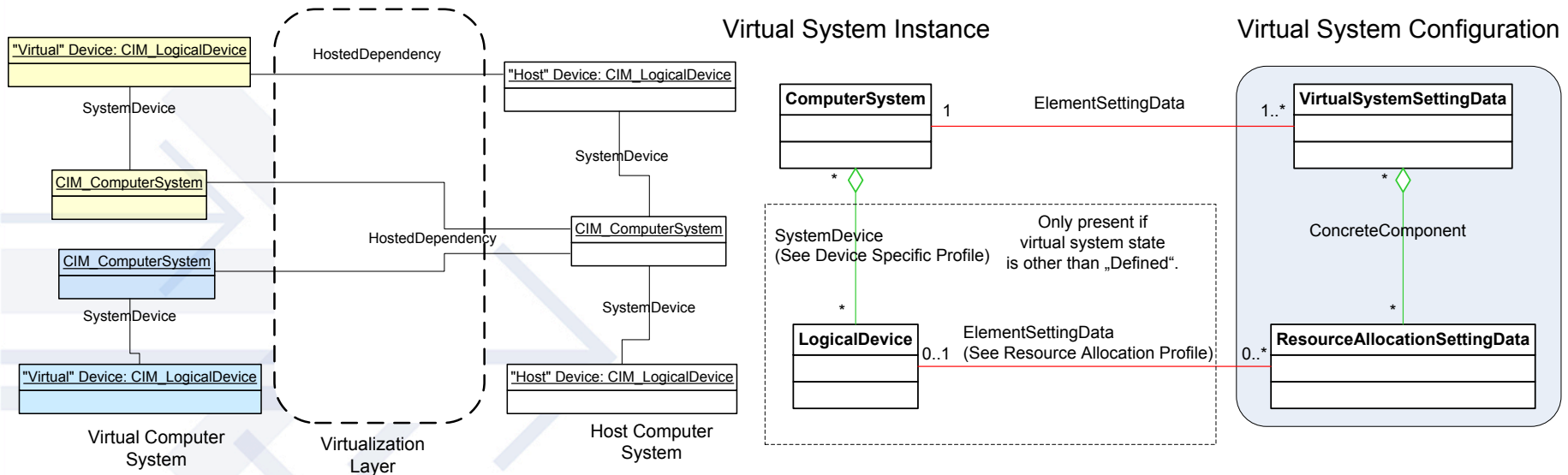

- Systems Management Architecture for Server Hardware
- A suite of specifications that deliver industry standard protocols/profiles to unify the management of servers
 - Vendor independent
 - Platform neutral
 - Independent of machine state
- SMASH specifications utilize the CIM data model and industry standard transports/security mechanisms
 - Align out-of-service with in-service manageability.
 - Align in-band with out-of-band manageability.
 - Customer Driven
- 1.0 Standard published Dec 2006
- 2.0 Standard published Sep 2007
- 2.1 Standard published in Dec 2014

SMASH 2.0 Features



Inventory

- Physical Asset including Asset Tags
- CPUs, Caches, System Memory
- Fans and Power Supplies
- Ethernet NICs and Storage
- PCI Devices
- BIOS/Firmware/Software components
- OS Type and Version

System Diagnostics

- Event Logs
- Text Console Redirection
- KVM Redirection

System Repair

- Firmware Update
- Software Update
- Remote Boot

User Account Management

- Username/password
- Roles and privileges

Monitoring

- Sensors
- LEDs
- Fan Speed
- Power Usage

Base System

- Base Server
- Modular System
- Service Processor
- SMASH Collection

BMC Configuration Management

- CLP Service & Admin Domain
- OOB Management Service
- Telnet/SSH configuration
- Media/KVM redirection services configuration
- Ethernet Port, IP Interface, DHCP Client, DNS Client

System Control

- Power State Control
- Boot Control
- Fan Speed Control
- Power Supply Control
- BIOS Management

Alerts and Events

- Progress events
- System Failures
- Operational Errors
- Watchdog events



- Desktop and mobile Architecture for System Hardware
- Web services based programmatic interface for desktop to mobile environment, including bladed PCs
- Utilizes the CIM Data Model
- Leveraging SMASH Profiles & Architecture
- Tackling tough issues like standardized Eventing
- 1.0 published Apr, 2007
- 1.1 published Dec 2007
- 1.2 published Dec 2014

DASH and SMASH Conformance



System Management Forum (SMF)

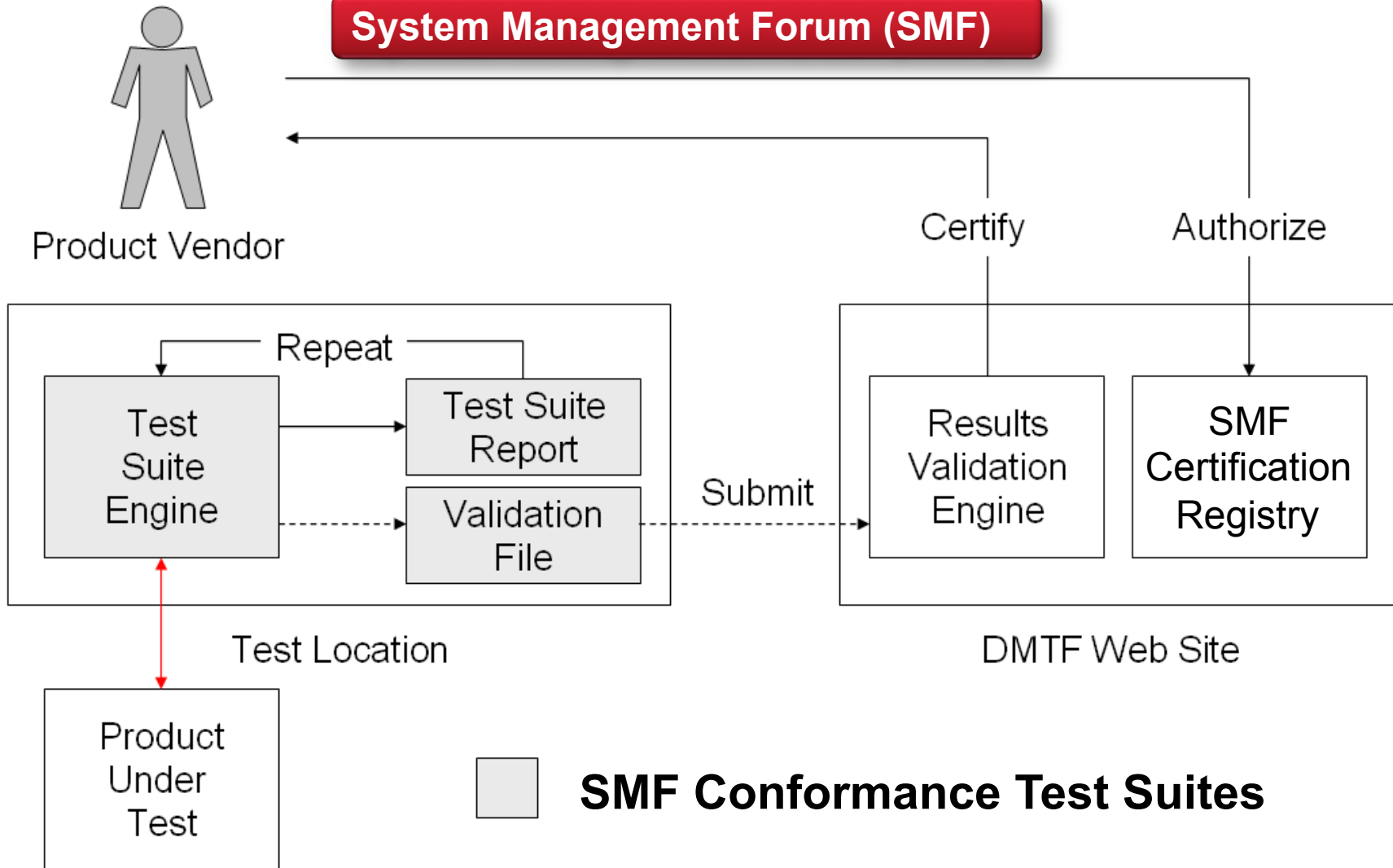

- Common Information Model
- Core Specification
 - “Meta”-model, high level concepts and language definitions
- “Core” and “Common” Models
 - Core Model contains info applicable to all management domains
 - Common Models address specific domains

- Application
- Database
- Device
- Event
- Interop
- Metrics
- Network
- Policy
- Systems
- User

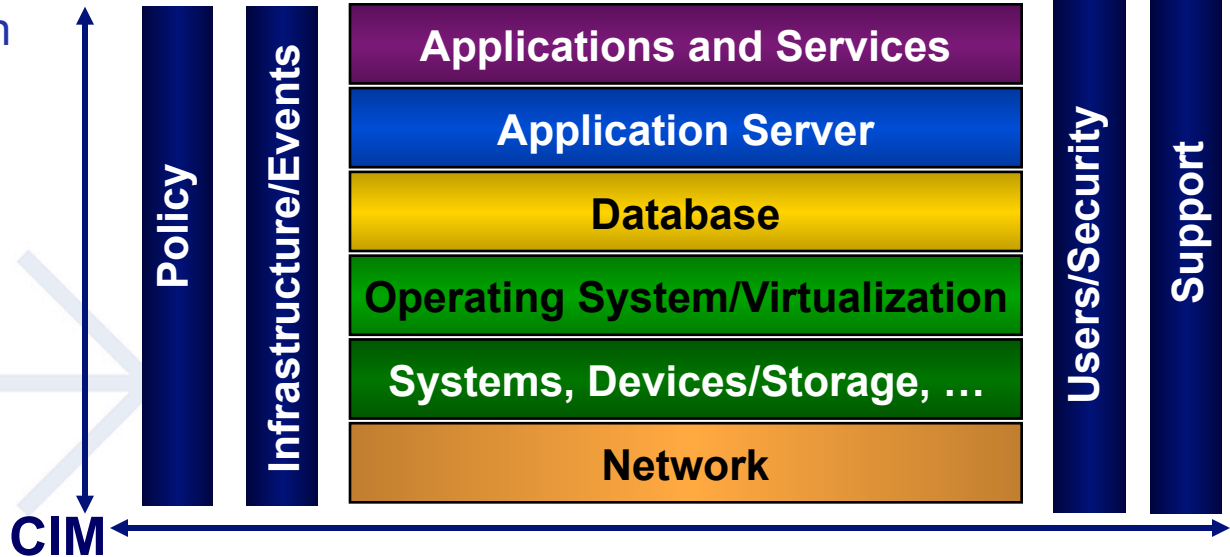

- Subclass from the Core Model

- A set of specifications published by DMTF
- Defines how resources modeled using the CIM can be discovered, accessed and manipulated.
- Provides the ability for the industry to deliver a well-integrated set of standard-based management tools
- Facilitates the exchange of data across otherwise disparate technologies and platforms
- Protocols
 - CIM-XML – CIM Operations over HTTP(S)
 - WS-Management - SOAP/XML over HTTP(S)
 - CIM-RS – Restful protocol (JSON/XML) over HTTP(S)



Redfish Scope and Goals

- *The DMTF's Scalable Platforms Management Forum (SPMF) is working to create and publish an open industry standard specification and schema that meets the expectations of end users for simple, modern and secure management of scalable platform hardware.*
- RESTful interface over HTTPS in JSON format based on OData v4
- Usable by client applications and browser-based GUIs
- A secure, multi-node capable replacement for previous interfaces
- Schema-backed human-readable output
- Covers popular use cases and customer requirements
- Intended to meet OCP Remote Machine Management requirements

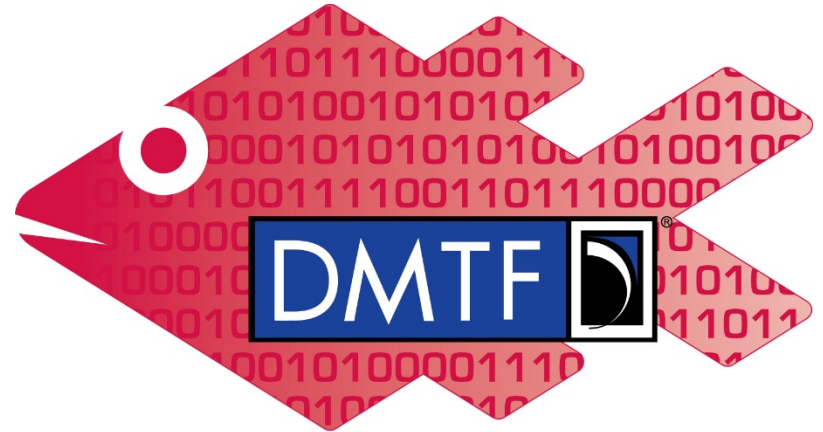

Redfish

Redfish v1.0 Feature Set

Retrieve “IPMI class” data

- Basic server identification and asset info
- Health state
- Temperature sensors and fans
- Power supply, power consumption and thresholds

Discovery

- Service endpoint (network-based discovery)
- System topology (rack/chassis/server/node)

Basic I/O infrastructure data

- Host NIC MAC address(es) for LOM devices
- Simple hard drive status / fault reporting

Security

- Session-based leverages HTTPS

Perform Common Actions

- Reboot / power cycle server
- Change boot order / device
- Set power thresholds

Access and Notification

- Serial console access via SSH
- Alert / event notification method(s)
- Event Log access method(s)

BMC infrastructure

- View / configure BMC network settings
- Manage local BMC user accounts

Platform Management Subsystem

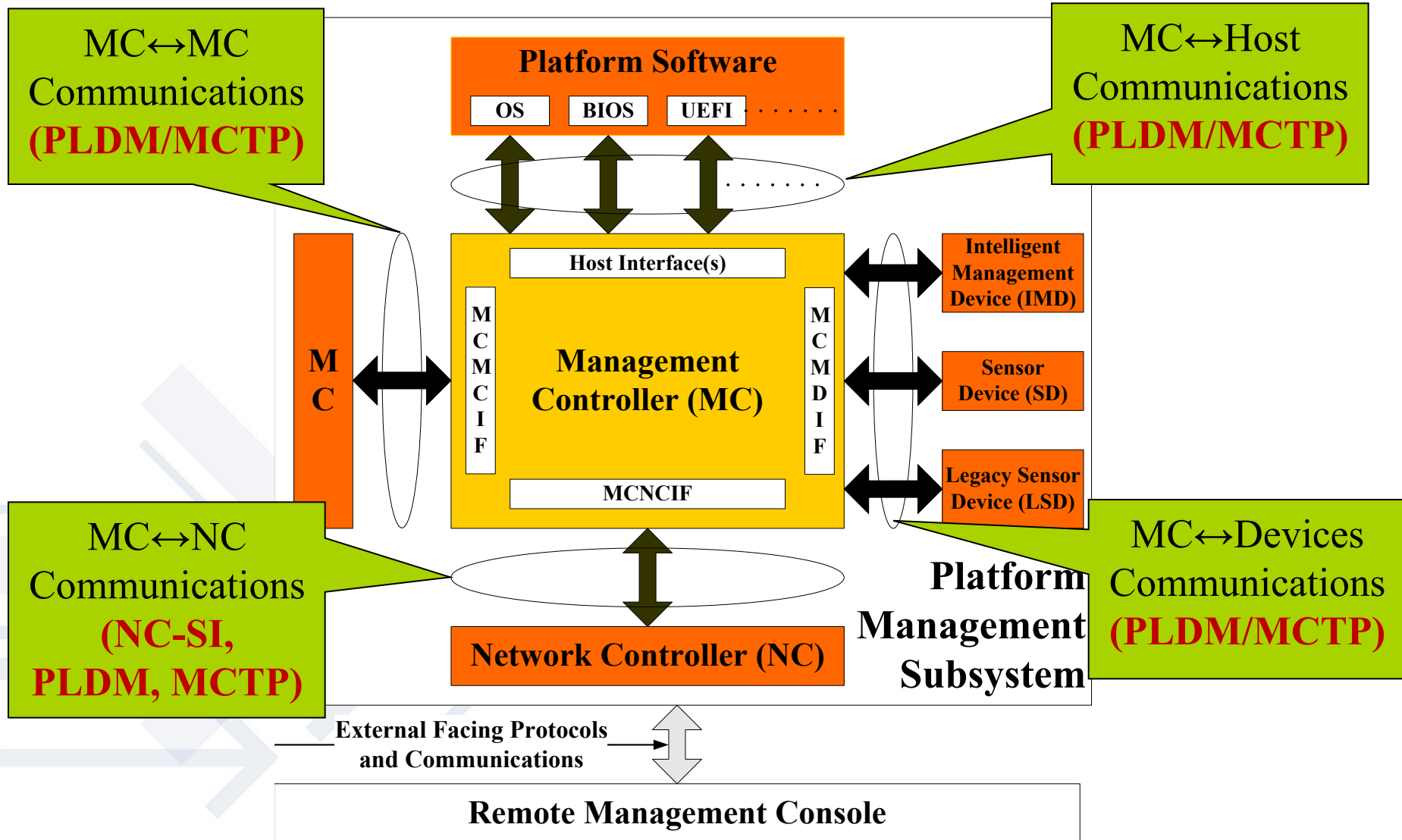



- **Platform Management Component Intercommunications**
- **Scope: “Inside the box” communication and functional interfaces between components within the platform management subsystem**
 - Mgmt Controller (MC) to Mgmt Controller
 - Mgmt Controller to Intelligent Management Device
 - Mgmt Controller to Network Controller
 - FW / SW to Mgmt Controller
- **Builds on learning from SMBIOS, ASF, & NC-SI**
- **Leverages SMBus, PCIe & other industry technologies**

PMCI technologies and interfaces are complementary to DMTF CIM Profiles/remote management protocols

SMBIOS

- 15+ years life
- 2B+ devices
- BIOS extension
- Provides system info
 - Make, Model, Serial #
 - BIOS version
 - Processor, memory...
- Table based access

CDM

- Common Diag Model
- Based on CIM
- Leverages CIM/WBEM
- Covers
 - Processor/Memory
 - Network Devices
 - Storage...
- Built in discovery

DMTF Technologies for NFV Phase 1

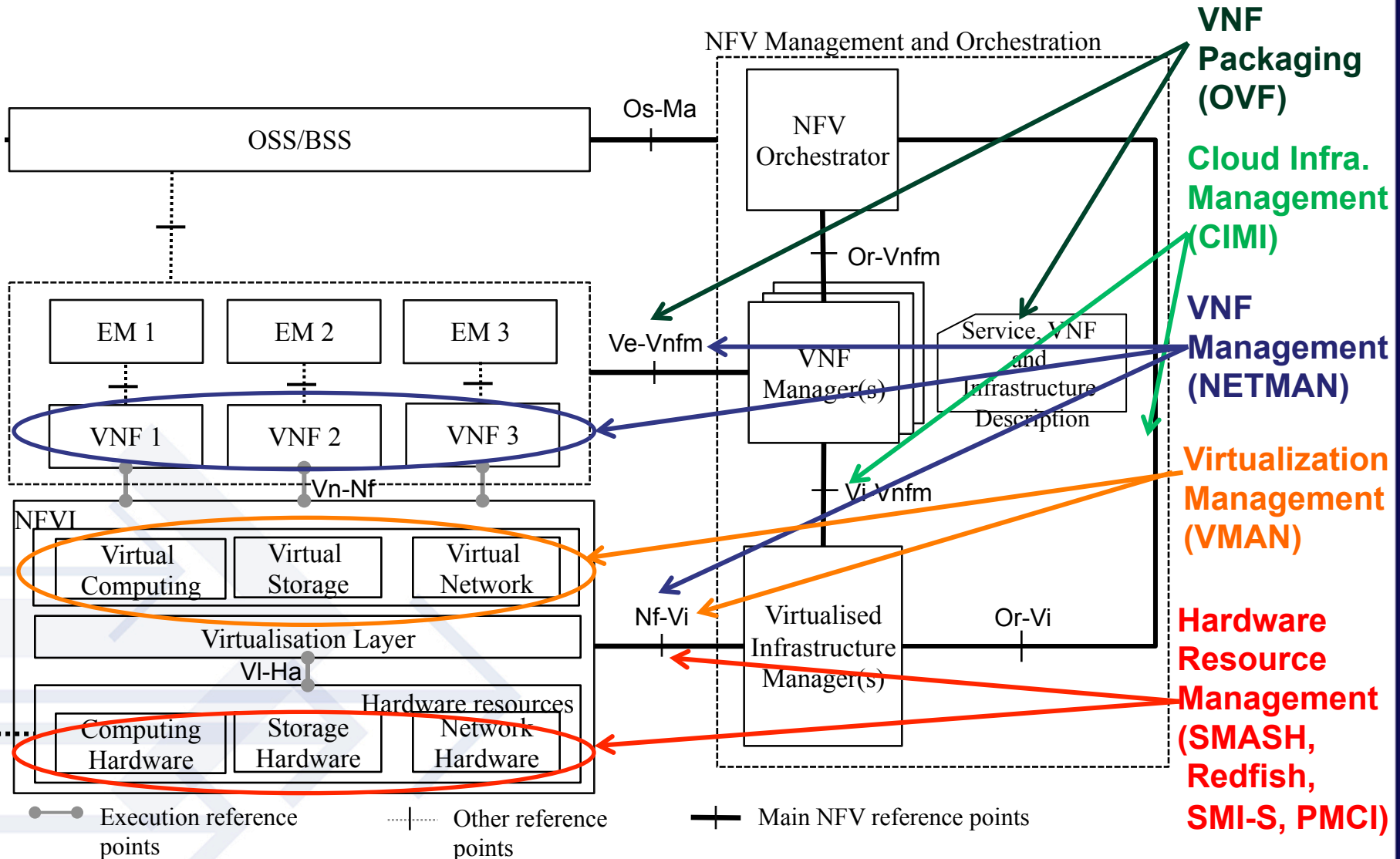

NFV MANO Architectural Framework and DMTF Standards

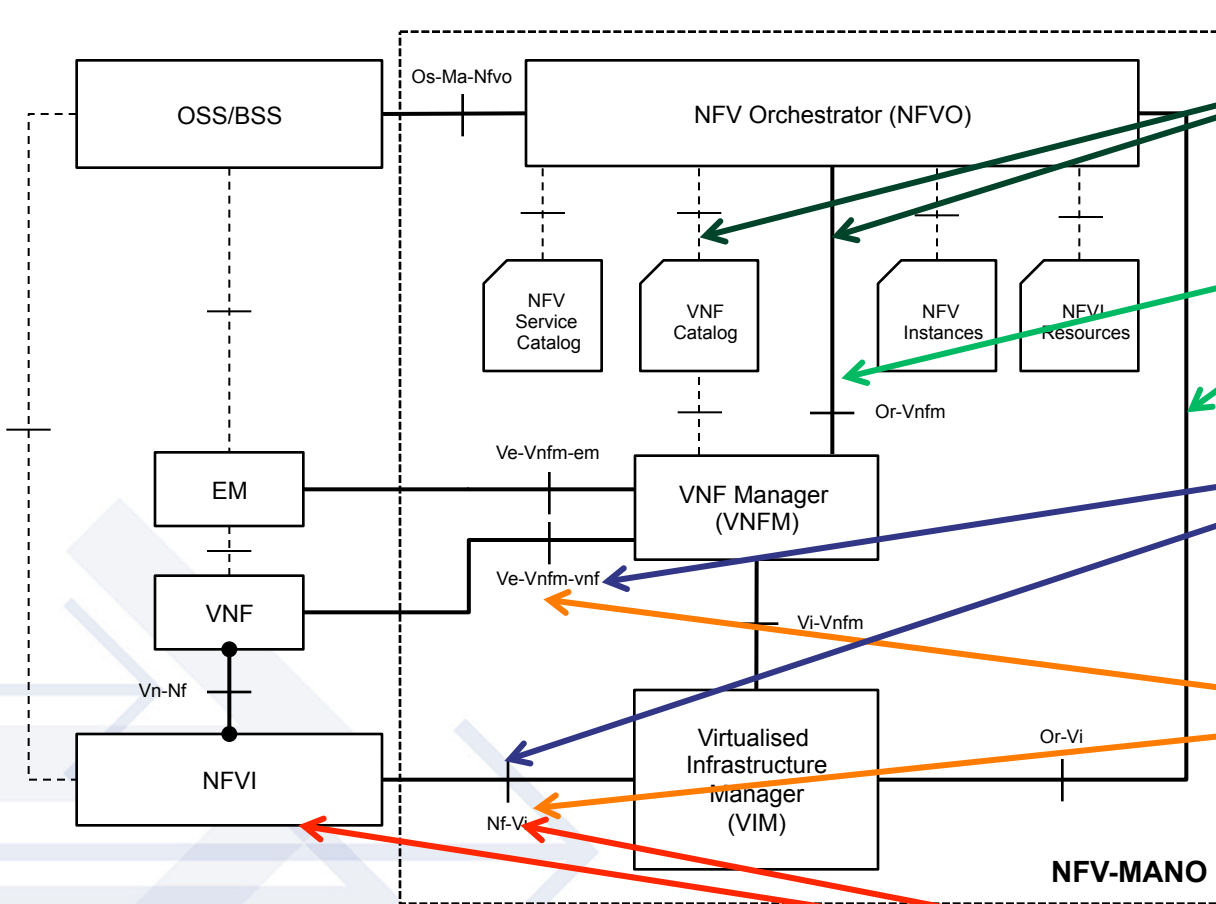

●—● Execution reference points - - - - - Other reference points +— Main NFV reference points

- VNF Packaging (OVF)**
- Cloud Infra. Management (CIMI)**
- VNF Management (NETMAN)**
- Virtualization Management (VMAN)**
- Hardware Resource Management (SMASH, Redfish, SMI-S, PMCI)**



DMTF Standards are synergistic to NFV MANO Arch

DMTF Standard/ Initiative	NFV MANO Functionality	Applicable Ref Points/ Artifacts
OVF	Packaging/distribution of VNFs	Nfvo-Vnfm (VNF descriptor usage)
NETMAN	VNF management Network management Network policy/service mgmt	VeEn-Vnfm, VeNf-Vnfm Nf-Vi
CIMI	Virtualized resource capacity/ catalog/performance management and orchestration	Vi-Vnfm, Nfvo-Vi
VMAN	Virtualized resource management	Nf-Vi, VeNf-Vnfm
Redfish/SMASH	Physical server infrastructure management	Nf-Vi
SMI-S (SNIA)	Storage management	Nf-Vi
PMCI	Physical platform component intercommunications	

History of activities within DMTF (as per E. R. knowledge)

- **June 2013**
 - DMTF work register between the DMTF and ETSI-NFV was approved
- **October 2013 (NFV#4)**
 - DMTF submitted an LS towards ETSI ISG NFV indicating that DMTF produces standards which may be relevant to ongoing ETSI NFV work.
 - ETSI ISG NFV responds that gap analysis towards existing standards is ongoing and the first set of ISG level documents are available on the open area.
- **Autumn 2013 / Winter 2014**
 - First mapping exercise (TC & WGs) to position DMTF standards on ETSI NFV Architecture
- **July 2014: some DMTF reps in ETSI NFV#7 give presentation on DMTF standards potentially applicable to the ETSI NFV MANO WG**
 - Single individuals active in DMTF participate to ETSI NFV meetings (#5, #6, #7). No formal LS from DMTF to ETSI NFV (& vice versa)
- **August 2014**
 - The ISG informs DMTF on the availability of the Draft ISG deliverables
- **November 2014 (NFV#8)**
 - DMTF submitted an LS towards ETSI ISG NFV asking the ISG to provide feedback on the draft version of the “Software Defined Data Center Definition White Paper”. The ISG informs DMTF that the ISG is undergoing changes in the workgroup structure and asks DMTF to inform ETSI ISG NFV when the final paper is ready for review.
- **February 2015 (NFV#9) (by Peter Worndle)**
 - Informative LS from DMTF to ETSI NFV on DMTF Groups structure, Study Items of potential interest to ETSI NFV, liaison activities with ETSI NFV, next meetings of WGs with potential interest to ETSI NFV

How to Work with the DMTF

- **Join the DMTF**
 - Scope of the DMTF is clear: it's all about management
 - Drive specifications through TC, conformance through the Interoperability Committee, messaging through the Marketing Committee and ground breaking areas through Incubators and International partnerships through Alliance and Regional Chapters
- **Members**
 - Active participation brings about standards based on best practices
 - Drive standards through participation
 - Consider bringing work into the DMTF
- **Alliance Partners**
 - DMTF Originated Work
 - **Feedback from the DMTF**
 - DSP Acquisition
 - Work In Progress Release capability
 - **Feedback into the DMTF**
 - Alliance Liaison
 - Joint Member (companies that are members of both organizations).
 - The DMTF Technology Adoption Policy
 - The DMTF Feedback Portal
 - Alliance Partner Originated Work
 - Similar mechanisms would speed things along if you wish DMTF input
- **Academic Partners**



Thank you